

# WARRIOR III

## PA-28-161

SN 2842001 AND UP

### PILOT'S OPERATING HANDBOOK

AND

### FAA APPROVED AIRPLANE FLIGHT MANUAL

Εγκρίθηκε βάσει της:  
ΥΠΑ/Δ 21Α/32417/11285  
Ημερομηνία: 26-08-2002  
ο Διευθυντής Πληθικών Προτύπων  
Κ. Τσιφτσής



AIRPLANE  
SERIAL NO. 2842158

AIRPLANE SX-ARD  
REGIST. NO. ~~N53453~~

PA-28-161  
REPORT: VB-1610 FAA APPROVED BY:

DATE OF APPROVAL:  
JULY 12, 1995

PETER E. PECK  
D.O.A. NO. SO-1  
THE NEW PIPER AIRCRAFT, INC.  
VERO BEACH, FLORIDA

FAA APPROVED IN NORMAL AND UTILITY CATEGORIES BASED ON CAR 3. THIS HANDBOOK INCLUDES THE MATERIAL REQUIRED TO BE FURNISHED TO THE PILOT BY CAR 3 AND CONSTITUTES THE APPROVED AIRPLANE FLIGHT MANUAL AND MUST BE CARRIED IN THE AIRPLANE AT ALL TIMES.

***WARNING***

EXTREME CARE MUST BE EXERCISED TO LIMIT THE USE OF THIS HANDBOOK TO APPLICABLE AIRCRAFT. THIS HANDBOOK IS VALID FOR USE WITH THE AIRPLANE IDENTIFIED ON THE FACE OF THE TITLE PAGE. SUBSEQUENT REVISIONS SUPPLIED BY PIPER MUST BE PROPERLY INSERTED.

Published by  
PUBLICATIONS DEPARTMENT  
Issued: July 12, 1995  
© 1995 THE NEW PIPER AIRCRAFT, INC.  
All Rights Reserved

**REPORT: VB-1610**

# WARRIOR III

## PA-28-161

SN 2842001 AND UP

## PILOT'S OPERATING HANDBOOK

AND

## FAA APPROVED AIRPLANE FLIGHT MANUAL

AIRPLANE  
SERIAL NO. \_\_\_\_\_

AIRPLANE  
REGIST. NO. \_\_\_\_\_

PA-28-161

REPORT: VB-1610 FAA APPROVED BY:

  
PETER E. PECK

D.O.A. NO. SO-1

THE NEW PIPER AIRCRAFT, INC.  
VERO BEACH, FLORIDA

DATE OF APPROVAL:  
JULY 12, 1995

FAA APPROVED IN NORMAL AND UTILITY CATEGORIES BASED ON CAR 3. THIS HANDBOOK INCLUDES THE MATERIAL REQUIRED TO BE FURNISHED TO THE PILOT BY CAR 3 AND CONSTITUTES THE APPROVED AIRPLANE FLIGHT MANUAL AND MUST BE CARRIED IN THE AIRPLANE AT ALL TIMES.

  
**Piper**<sup>TM</sup>

**WARNING**

EXTREME CARE MUST BE EXERCISED TO LIMIT THE USE OF THIS HANDBOOK TO APPLICABLE AIRCRAFT. THIS HANDBOOK IS VALID FOR USE WITH THE AIRPLANE IDENTIFIED ON THE FACE OF THE TITLE PAGE. SUBSEQUENT REVISIONS SUPPLIED BY PIPER MUST BE PROPERLY INSERTED.

Published by  
TECHNICAL PUBLICATIONS

Issued: July 12, 1995

© 1995, 1997, 1999-2011 PIPER AIRCRAFT, INC.  
All Rights Reserved

# WARRIOR III

## PA-28-161

SN 2842001 AND UP

### PILOT'S OPERATING HANDBOOK

AND

### FAA APPROVED AIRPLANE FLIGHT MANUAL

AIRPLANE  
SERIAL NO. \_\_\_\_\_

AIRPLANE  
REGIST. NO. \_\_\_\_\_

PA-28-161

REPORT: VB-1610 FAA APPROVED BY:



PETER E. PECK

D.O.A. NO. SO-1

DATE OF APPROVAL:  
JULY 12, 1995

THE NEW PIPER AIRCRAFT, INC.  
VERO BEACH, FLORIDA

FAA APPROVED IN NORMAL AND UTILITY CATEGORIES BASED ON CAR 3. THIS HANDBOOK INCLUDES THE MATERIAL REQUIRED TO BE FURNISHED TO THE PILOT BY CAR 3 AND CONSTITUTES THE APPROVED AIRPLANE FLIGHT MANUAL AND MUST BE CARRIED IN THE AIRPLANE AT ALL TIMES.

  
**Piper**<sup>TM</sup>

**WARNING**

EXTREME CARE MUST BE EXERCISED TO LIMIT THE USE OF THIS HANDBOOK TO APPLICABLE AIRCRAFT. THIS HANDBOOK IS VALID FOR USE WITH THE AIRPLANE IDENTIFIED ON THE FACE OF THE TITLE PAGE. SUBSEQUENT REVISIONS SUPPLIED BY PIPER MUST BE PROPERLY INSERTED.

Published by  
TECHNICAL PUBLICATIONS



Issued: July 12, 1995

© 2008 PIPER AIRCRAFT, INC.

All Rights Reserved

## PILOT'S OPERATING HANDBOOK LOG OF REVISIONS

Current Revisions to the PA-28-161 WARRIOR III Pilot's Operating Handbook, REPORT: VB-1610 issued JULY 12, 1995.

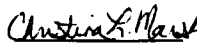
Revision Number and Code	Revised Pages	Description of Revisions	FAA Approval Signature and Date
Rev. 1 (PR950912)	v 9-i 9-9 thru 9-20	Added Revision 1 to L of R pg Revised T.O.C. Added Supplement 2 KLN 89B GPS	 Peter E. Peck FAA/DOA Coordinator  <u>Sept. 12, 1995</u> Date
Rev. 2 (PR970306)	v 2-8  7-12	Added Revision 2 to L of R pg Revised para. 2.25, removed checklist and added placard Revised Fig. 7-11	 Peter E. Peck FAA/DOA Coordinator  <u>March 6, 1997</u> Date
Rev. 3 (PR991130)	v 4-6 4-7 4-8 4-11 4-15 4-16 4-17 4-19 4-24 7-i 9-i 9-21 thru 9-30	Added Revision 3 to L of R pg Revised para. 4.5. Revised para. 4.5. Revised para. 4.5. Revised para. 4.5. Revised para. 4.13. Revised para. 4.13. Revised para. 4.13. Revised para. 4.21. Revised para. 4.33. Revised T of C. Revised T of C. Added Supplements 3 and 4.	 Christina L. Marsh FAA/DOA Coordinator  <u>Nov. 30, 1999</u> Date

**ISSUED: JULY 12, 1995**  
**REVISED: NOVEMBER 30, 1999**

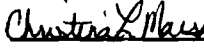
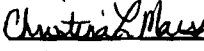
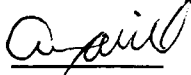
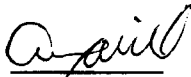

**REPORT: VB-1610**

**PILOT'S OPERATING HANDBOOK LOG OF REVISIONS**



Revision Number and Code	Revised Pages	Description of Revisions	FAA Approval Signature and Date
Rev. 4 (PR001221)	vi 9-i 9-27 9-31 thru 9-40	Revised L of R. Revised T of C. Added info. to section 4. Added Supplement 5.	 Christina L. Marsh <hr/> Dec. 21, 2000 Date
Rev. 5 (PR010102)	vi 9-i 9-41 thru 9-46 9-47 thru 9-52 9-53 thru 9-56	Revised L of R. Revised T of C. Added pages and Supplement 6.  Added pages and Supplement 7.  Added pages and Supplement 8.	 Christina L. Marsh <hr/> Jan. 2, 2001 Date
Rev. 6 (PR011101)	vi 2-4 7-21 9-i	Revised L of R. Revised para. 2.9. Revised para. 7.23. Revised T of C.	 Albert J. Mill <hr/> Nov. 1, 2001 Date
Rev. 7 (PR020814)	vi 2-9	Added Rev. 7 to L of R. Revised para. 2.25.	 Albert J. Mill <hr/> August 14, 2002 Date

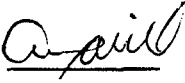

**PILOT'S OPERATING HANDBOOK LOG OF REVISIONS**

Revision Number and Code	Revised Pages	Description of Revisions	FAA Approval Signature and Date		
Rev. 8 (PR031210)	iii	Added Warning and moved info. to page iv.	 Albert J. Mill <u>Dec. 10, 2003</u> Date		
	iv	Moved info. from page iii.			
	vi-a	Added page and Rev. 8 to L of R.			
	vi-b	Added page.			
	8-1	Moved info. to page 8-1b and revised para. 8.1.			
	8-1a	Added page and revised para. 8.1.			
	8-1b	Added page and moved info. from pages 8-1 and 8-2.			
	8-2	Moved info. to page 8-1b and revised para. 8.3.			
	9-i	Revised T of C.			
	9-57 thru 9-60	Added pages and Supplement 9.			
Rev. 9 (PR041007)	vi-a	Added Rev. 9 to L of R.	 Linda J. Dicken October 7, 2004		
	9-i	Revised T of C.			
	9-61 thru 9-78	Added pages and Supplement 10.			
	9-79 thru 9-82	Added pages and Supplement 11.			
	Rev. 10 (PR050912)	vi-a		Added Rev. 10 to L or R.	 Linda J. Dicken Sept. 12, 2005
		9-i		Revised T of C.	
9-61 thru 9-88		Revised Supplement 10.			
9-89 thru 9-92		Revised page numbers.			
9-93 thru 9-102		Added pages and Supplement 12.			

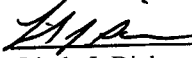

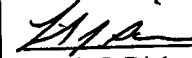
**PILOT'S OPERATING HANDBOOK LOG OF REVISIONS**

Revision Number and Code	Revised Pages	Description of Revisions	FAA Approval Signature and Date
Rev. 11 (PR051128)	vi-b 9-66 9-69 9-73	Added Rev. 11 to L of R. Revised Section 3. Revised Section 3. Revised Section 3.	 Linda J. Dicken Nov. 28, 2005
Rev. 12 (PR060109)	vi-b 9-i 9-61 thru 9-88	Added Rev. 12 to L of R. Revised T of C. Revised Supplement 10.	 Linda J. Dicken Jan. 9, 2006
Rev. 13 (PR060207)	vi-b 9-i 9-70 9-103 thru 9-138	Added Rev. 13 to L of R. Revised T of C. Revised Section 3. Added pages and Supplement 13.	 Linda J. Dicken Feb. 7, 2006
Rev. 14 (PR060411)	vi-b 9-81 9-129	Added Rev. 14 to L of R. Revised Section 7A. Revised Section 7A.	 Linda J. Dicken April 11, 2006
Rev. 15 (PR061218)	vi-b 4-6 4-7 4-15 4-16 9-77 thru 9-80 9-124 thru 9-127	Added Rev. 15 to L of R. Revised para. 4.5. Revised para. 4.5. Revised para. 4.11 & 4.13. Revised para. 4.13. Revised Section 4.  Revised Section 4.	 Linda J. Dicken Dec. 18, 2006

**REPORT: VB-1610**  
vi-b

**ISSUED: JULY 12, 1995**  
**REVISED: DECEMBER 18, 2006**

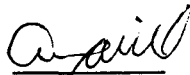
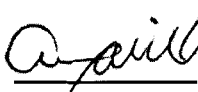
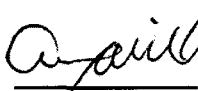
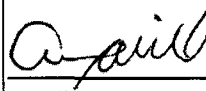
**PILOT'S OPERATING HANDBOOK LOG OF REVISIONS**

Revision Number and Code	Revised Pages	Description of Revisions	FAA Approval Signature and Date
Rev. 16 (PR071029)	vi-c vi-d 7-10	Added page and Rev. 16 to L of R. Added page. Revised para. 7.13.	 Albert J. Mill October 29, 2007
Rev. 17 (PR080523)	i ii vi vi-c vii viii 9-i 9-139 thru 9-150	Updated Piper logo. Updated publication info and added dates to footer. Corrected footer text. Added Rev. 17 to L of R. Added issue date to footer. Added issue date to footer. Added Supp 14 to Section 9 TOC. Added Supp 14 to Section 9.	 Albert J. Mill May 23, 2008
Rev. 18 (PR081015)	vi-c 9-i thru 9-ii 9-ii 9-151 thru 9-164	Added Rev. 18 to L of R. Added Page Headers.  Added Supp. 15 and 16 items to Section 9 TOC. Added Supp. 15 and 16 to Section 9.	 Albert J. Mill October 15, 2008
Rev. 19 (PR090615)	vi-c 8-1b 9-62 9-104	Added Rev. 19 to L of R. Revised Para. 8.1. Revised Section 1. Revised Section 1.	 Albert J. Mill June 15, 2009
Rev. 20 (PR100224)	vi-c 9-147	Added Rev. 20 to L of R. Revised Section 4.	 Wayne Gaulzetti February 24, 2010

## PILOT'S OPERATING HANDBOOK LOG OF REVISIONS

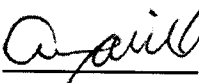
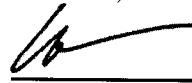
Revision Number and Code	Revised Pages	Description of Revisions	FAA Approval Signature and Date
Rev. 21 (PR100324)	vi-d 2-9 7-23 7-24	Added Rev. 21 to L of R. Revised Para. 2.25. Revised Para. 7.35. Revised Para. 7.35	 <hr/> Albert J. Mill March 24, 2010
Rev. 22 (PR111121)	ii vi-d 2-9 4-17	Updated copyright dates. Added Rev. 22 to L of R. Revised Para. 2.25. Revised Para. 4.13.	 <hr/> Wayne E. Gaulzetti November 21, 2011

## TABLE OF CONTENTS

### SECTION 1

#### GENERAL

Paragraph No.		Page No.
1.1	Introduction .....	1-1
1.3	Engines .....	1-3
1.5	Propellers.....	1-3
1.7	Fuel.....	1-3
1.9	Oil.....	1-4
1.11	Maximum Weights .....	1-4
1.13	Standard Airplane Weight .....	1-4
1.15	Baggage Space .....	1-4
1.17	Specific Loadings.....	1-4
1.19	Symbols, Abbreviations and Terminology .....	1-5

**THIS PAGE INTENTIONALLY LEFT BLANK**

**REPORT: VB-1610**

**1-ii**

## APPLICABILITY

Application of this handbook is limited to the specific Piper PA-28-161 model airplane designated by serial number and registration number on the face of the title page of this handbook.

This handbook cannot be used for operational purposes unless kept in a current status.

## REVISIONS

The information compiled in the Pilot's Operating Handbook, with the exception of the equipment list, will be kept current by revisions distributed to the airplane owners. The equipment list was current at the time the airplane was licensed by the manufacturer and thereafter must be maintained by the owner.

Revision material will consist of information necessary to update the text of the present handbook and/or to add information to cover added airplane equipment.

### I. Revisions

Revisions will be distributed whenever necessary as complete page replacements or additions and shall be inserted into the handbook in accordance with the instructions given below:

1. Revision pages will replace only pages with the same page number.
2. Insert all additional pages in proper numerical order within each section.
3. Page numbers followed by a small letter shall be inserted in direct sequence with the same common numbered page.

### II. Identification of Revised Material

Revised text and illustrations shall be indicated by a black vertical line along the outside margin of the page, opposite revised, added or deleted material. A line along the outside margin of the page opposite the page number will indicate that an entire page was added.

Black lines will indicate only current revisions with changes and additions to or deletions of existing text and illustrations. Changes in capitalization, spelling, punctuation or the physical location of material on a page will not be identified by symbols.

### **ORIGINAL PAGES ISSUED**

The original pages issued for this handbook prior to revision are given below:

Title, ii through viii, 1-1 through 1-10, 2-1 through 2-10, 3-1 through 3-16, 4-1 through 4-26, 5-1 through 5-30, 6-1 through 6-14, 7-1 through 7-24, 8-1 through 8-20, 9-1 through 9-8, and 10-1 through 10-2.



## **TABLE OF CONTENTS**

<b>SECTION 1</b>	<b>GENERAL</b>
<b>SECTION 2</b>	<b>LIMITATIONS</b>
<b>SECTION 3</b>	<b>EMERGENCY PROCEDURES</b>
<b>SECTION 4</b>	<b>NORMAL PROCEDURES</b>
<b>SECTION 5</b>	<b>PERFORMANCE</b>
<b>SECTION 6</b>	<b>WEIGHT AND BALANCE</b>
<b>SECTION 7</b>	<b>DESCRIPTION AND OPERATION OF THE AIRPLANE AND ITS SYSTEMS</b>
<b>SECTION 8</b>	<b>AIRPLANE HANDLING, SERVICING AND MAINTENANCE</b>
<b>SECTION 9</b>	<b>SUPPLEMENTS</b>
<b>SECTION 10</b>	<b>OPERATING TIPS</b>

**THIS PAGE INTENTIONALLY LEFT BLANK**

**SECTION I**

**GENERAL**

**1.1 INTRODUCTION**

This Pilot's Operating Handbook is designed for maximum utilization as an operating guide for the pilot. It includes the material required to be furnished to the pilot by the FAR/CAR. It also contains supplemental data supplied by the airplane manufacturer.

This handbook is not designed as a substitute for adequate and competent flight instruction, knowledge of current airworthiness directives, applicable federal air regulations or advisory circulars. It is not intended to be a guide for basic flight instruction or a training manual and should not be used for operational purposes unless kept in a current status.

Assurance that the airplane is in an airworthy condition is the responsibility of the owner. The pilot in command is responsible for determining that the airplane is safe for flight. The pilot is also responsible for remaining within the operating limitations as outlined by instrument markings, placards, and this handbook.

Although the arrangement of this handbook is intended to increase its in-flight capabilities, it should not be used solely as an occasional operating reference. The pilot should study the entire handbook to familiarize himself with the limitations, performance, procedures and operational handling characteristics of the airplane before flight.

The handbook has been divided into numbered (arabic) sections, each provided with a finger-tip tab divider for quick reference. The limitations and emergency procedures have been placed ahead of the normal procedures, performance and other sections to provide easier access to information that may be required in flight. The Emergency Procedures Section has been furnished with a red tab divider to present an instant reference to the section. Provisions for expansion of the handbook have been made by the deliberate omission of certain paragraph numbers, figure numbers, item numbers and pages noted as being intentionally left blank.

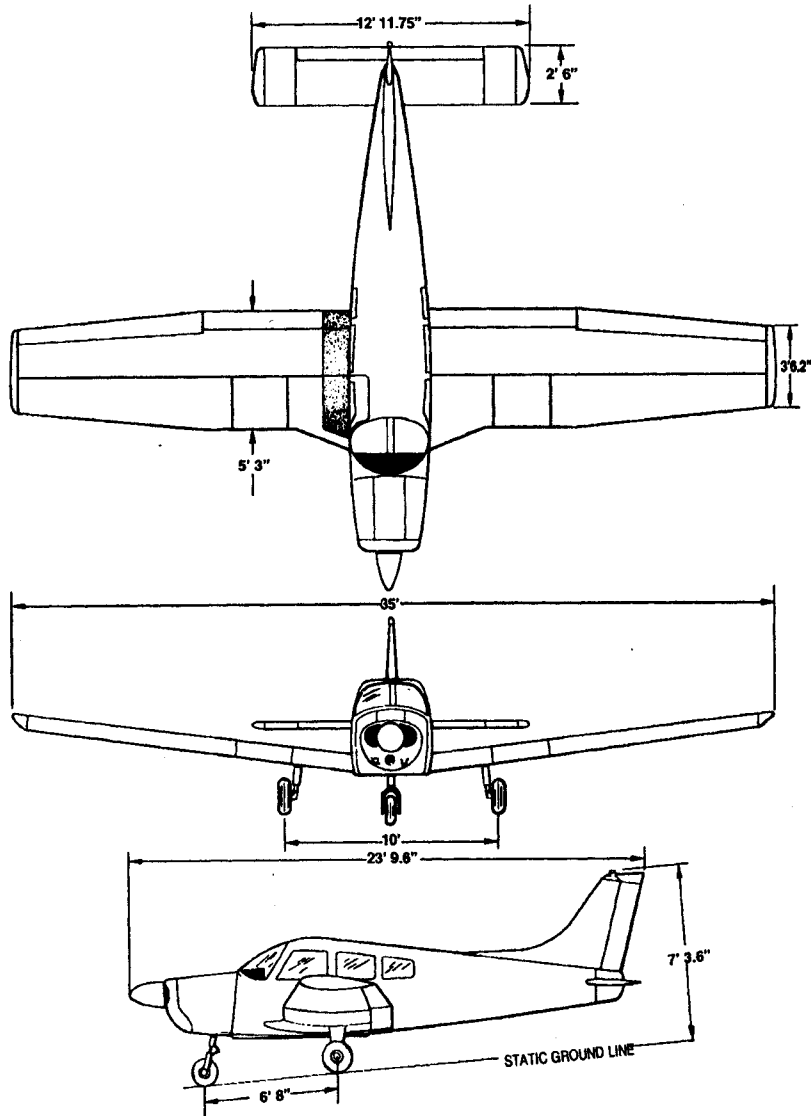

**THREE VIEW**  
Figure 1-1

**1.3 ENGINES**

(a) Number of Engines	1
(b) Engine Manufacturer	Lycoming
(c) Engine Model Number	O-320-D3G
(d) Rated Horsepower	160
(e) Rated Speed (rpm)	2700
(f) Bore (inches)	5.125
(g) Stroke (inches)	3.875
(h) Displacement (cubic inches)	319.8
(i) Compression Ratio	8.5:1
(j) Engine Type	Four Cylinder, Direct Drive, Horizontally Opposed, Air Cooled

**1.5 PROPELLERS**

(a) Number of Propellers	1
(b) Propeller Manufacturer	Sensenich
(c) Model	74DM6-0-60
(d) Number of Blades	2
(e) Propeller Diameter (inches)	
(1) Maximum	74
(2) Minimum	72
(f) Propeller Type	Fixed Pitch

**1.7 FUEL**

**AVGAS ONLY**

(a) Fuel Capacity (U.S. gal) (total)	50
(b) Usable Fuel (U.S. gal) (total)	48
(c) Fuel	
(1) Minimum Octane	100 Green or 100LL Blue Aviation Grade
(2) Alternate Fuel	Refer to Fuel Requirements, Section 8 - Handling, Servicing and Maintenance.

**1.9 OIL**

(a) Oil Capacity (U.S. quarts)		8
(b) Oil Specification		Refer to latest issue of Lycoming Service Instruction 1014.
(c) Oil Viscosity per Average Ambient Temp. for Starting		
	Single	Multi
(1) Above 60°F	S.A.E. 50	S.A.E. 40 or 50
(2) 30°F to 90°F	S.A.E. 40	S.A.E. 40
(3) 0°F to 70°F	S.A.E. 30	S.A.E. 40 or 20W-30
(4) Below 10°F	S.A.E. 20	S.A.E. 20W-30

**1.11 MAXIMUM WEIGHTS**

	Normal	Utility
(a) Maximum Takeoff Weight (lbs)	2440	2020
(b) Maximum Ramp Weight (lbs)	2447	2027
(c) Maximum Landing Weight (lbs)	2440	2020
(d) Maximum Weight in Baggage Compartment (lbs)	200	0

**1.13 STANDARD AIRPLANE WEIGHTS**

Refer to Figure 6-5 for the Standard Empty Weight and the Useful Load.

**1.15 BAGGAGE SPACE**

(a) Compartment Volume (cubic feet)	24
-------------------------------------	----

**1.17 SPECIFIC LOADINGS**

(a) Wing Loading (lbs per sq ft)	14.4
(b) Power Loading (lbs per hp)	15.3

**1.19 SYMBOLS, ABBREVIATIONS AND TERMINOLOGY**

The following definitions are of symbols, abbreviations and terminology used throughout the handbook and those which may be of added operational significance to the pilot.

(a) General Airspeed Terminology and Symbols

CAS	Calibrated Airspeed means the indicated speed of an aircraft, corrected for position and instrument error. Calibrated airspeed is equal to true airspeed in standard atmosphere at sea level.
KCAS	Calibrated Airspeed expressed in Knots.
GS	Ground Speed is the speed of an airplane relative to the ground.
IAS	Indicated Airspeed is the speed of an aircraft as shown on the airspeed indicator when corrected for instrument error. IAS values published in this handbook assume zero instrument error.
KIAS	Indicated Airspeed expressed in Knots.
M	Mach Number is the ratio of true airspeed to the speed of sound.
TAS	True Airspeed is the airspeed of an airplane relative to undisturbed air which is the CAS corrected for altitude, temperature and compressibility.
VA	Maneuvering Speed is the maximum speed at which application of full available aerodynamic control will not overstress the airplane.
V <sub>FE</sub>	Maximum Flap Extended Speed is the highest speed permissible with wing flaps in a prescribed extended position.

V <sub>NE/MNE</sub>	Never Exceed Speed or Mach Number is the speed limit that should not be exceeded at any time.
V <sub>NO</sub>	Maximum Structural Cruising Speed is the speed that should not be exceeded except in smooth air and then only with caution.
V <sub>S</sub>	Stalling Speed or the minimum steady flight speed at which the airplane is controllable.
V <sub>SO</sub>	Stalling Speed or the minimum steady flight speed at which the airplane is controllable in the landing configuration.
V <sub>X</sub>	Best Angle-of-Climb Speed is the airspeed which delivers the greatest gain of altitude in the shortest possible horizontal distance.
V <sub>Y</sub>	Best Rate-of-Climb Speed is the airspeed which delivers the greatest gain in altitude in the shortest possible time.

**(b) Meteorological Terminology**

ISA	International Standard Atmosphere in which: The air is a dry perfect gas; The temperature at sea level is 15 Celsius (59 Fahrenheit); The pressure at sea level is 29.92 inches Hg (1013.2 mb); The temperature gradient from sea level to the altitude at which the temperature is -56.5C (-69.7F) is -0.00198C (-0.003564F) per foot and zero above that altitude.
OAT	Outside Air Temperature is the free air static temperature obtained either from inflight temperature indications or ground meteorological sources, adjusted for instrument error and compressibility effects.



**Indicated Pressure Altitude**      The number actually read from an altimeter when the barometric subscale has been set to 29.92 inches of mercury (1013.2 millibars).

**Pressure Altitude**      Altitude measured from standard sea-level pressure (29.92 in. Hg) by a pressure or barometric altimeter. It is the indicated pressure altitude corrected for position and instrument error. In this handbook, altimeter instrument errors are assumed to be zero.

**Station Pressure**      Actual atmospheric pressure at field elevation.

**Wind**      The wind velocities recorded as variables on the charts of this handbook are to be understood as the headwind or tailwind components of the reported winds.

**(c) Power Terminology**

**Takeoff Power**      Maximum power permissible for takeoff.

**Maximum Continuous Power**      Maximum power permissible continuously during flight.

**Maximum Climb Power**      Maximum power permissible during climb.

**Maximum Cruise Power**      Maximum power permissible during cruise.

**(d) Engine Instruments**

**EGT Gauge**      Exhaust Gas Temperature Gauge

(e) Airplane Performance and Flight Planning Terminology

Climb Gradient	The demonstrated ratio of the change in height during a portion of a climb, to the horizontal distance traversed in the same time interval.
Demonstrated Crosswind Velocity	The demonstrated crosswind velocity is the velocity of the crosswind component for which adequate control of the airplane during takeoff and landing was actually demonstrated during certification tests.
Accelerate-Stop Distance	The distance required to accelerate an airplane to a specified speed and, assuming failure of an engine at the instant that speed is attained, to bring the airplane to a stop.
Route Segment	A part of a route. Each end of that part is identified by (1) a geographical location or (2) a point at which a definite radio fix can be established.

(f) Weight and Balance Terminology

Reference Datum	An imaginary vertical plane from which all horizontal distances are measured for balance purposes.
Station	A location along the airplane fuselage usually given in terms of distance from the reference datum.
Arm	The horizontal distance from the reference datum to the center of gravity (C.G.) of an item.

Moment	The product of the weight of an item multiplied by its arm. (Moment divided by a constant is used to simplify balance calculations by reducing the number of digits.)
Center of Gravity (C.G.)	The point at which an airplane would balance if suspended. Its distance from the reference datum is found by dividing the total moment by the total weight of the airplane.
C.G. Arm	The arm obtained by adding the airplane's individual moments and dividing the sum by the total weight.
C.G. Limits	The extreme center of gravity locations within which the airplane must be operated at a given weight.
Usable Fuel	Fuel available for flight planning.
Unusable Fuel	Fuel remaining after a runout test has been completed in accordance with governmental regulations.
Standard Empty Weight	Weight of a standard airplane including unusable fuel, full operating fluids and full oil.
Basic Empty Weight	Standard empty weight plus optional equipment.
Payload	Weight of occupants, cargo and baggage.
Useful Load	Difference between takeoff weight, or ramp weight if applicable, and basic empty weight.
Maximum Ramp Weight	Maximum weight approved for ground maneuver. (It includes weight of start, taxi and run up fuel.)

Maximum  
Takeoff Weight

Maximum weight approved for the start  
of the takeoff run.

Maximum  
Landing Weight

Maximum weight approved for the landing  
touchdown.

Maximum Zero  
Fuel Weight

Maximum weight exclusive of usable fuel.

## TABLE OF CONTENTS

### SECTION 2 LIMITATIONS

Paragraph No.		Page No.
2.1	General .....	2-1
2.3	Airspeed Limitations .....	2-1
2.5	Airspeed Indicator Markings.....	2-2
2.7	Power Plant Limitations .....	2-2
2.9	Power Plant Instrument Markings.....	2-3
2.11	Weight Limits .....	2-4
2.13	Center of Gravity Limits .....	2-5
2.15	Maneuver Limits .....	2-5
2.17	Flight Load Factors .....	2-6
2.19	Kinds of Operation Equipment List .....	2-6
2.21	Fuel Limitations .....	2-7
2.25	Placards .....	2-8

**THIS PAGE INTENTIONALLY LEFT BLANK**

**SECTION 2  
LIMITATIONS**

**2.1 GENERAL**

This section provides the FAA Approved operating limitations, instrument markings, color coding and basic placards necessary for operation of the airplane and its systems.

This airplane must be operated as a normal or utility category airplane in compliance with the operating limitations stated in the form of placards and markings and those given in this section and handbook.

Limitations associated with those optional systems and equipment which require handbook supplements can be found in Section 9 (Supplements).

**2.3 AIRSPEED LIMITATIONS**

SPEED	KIAS	KCAS
Never Exceed Speed (VNE) - Do not exceed this speed in any operation.	160	153
Maximum Structural Cruising Speed (VNO) - Do not exceed this speed except in smooth air and then only with caution.	126	122
Maximum Flaps Extended Speed (VFE) - Do not exceed this speed with the flaps extended.	103	100

**SECTION 2**  
**LIMITATIONS**

**PA-28-161, WARRIOR III**

SPEED	KIAS	KCAS
Design Maneuvering Speed (VA) - Do not make full or abrupt control movements above this speed.		
At 2440 LBS. G.W.	111	108
At 1531 LBS. G.W.	88	89

**CAUTION**

Maneuvering speed decreases at lighter weight as the effects of aerodynamic forces become more pronounced. Linear interpolation may be used for intermediate gross weights. Maneuvering speed should not be exceeded while operating in rough air.

**2.5 AIRSPEED INDICATOR MARKINGS**

MARKING	KIAS
Red Radial Line (Never Exceed)	160
Yellow Arc(Caution Range - Smooth Air Only)	126 to 160
Green Arc (Normal Operating Range)	50 to 126
White Arc (Flap Down)	44 to 103

**2.7 POWER PLANT LIMITATIONS**

(a) Number of Engines	1
(b) Engine Manufacturer	Lycoming
(c) Engine Model No.	O-320-D3G
(d) Engine Operating Limits	
(1) Maximum Horsepower	160
(2) Maximum Rotation Speed (RPM)	2700
(3) Maximum Oil Temperature	245°F
(e) Oil Pressure	
Minimum (red line)	25 PSI
Maximum (red line)	115 PSI
(f) Fuel Pressure	
Minimum (red line)	.5 PSI
Maximum (red line)	8 PSI
(g) Fuel (AVGAS ONLY) (minimum grade)	100 or 100LL Aviation Grade



(h) Number of Propellers	1
(i) Propeller Manufacturer	Sensenich
(j) Propeller Model	74DM6-0-60
(k) Propeller Diameter	
Minimum	72 IN.
Maximum	74 IN.
(l) 74DM6-0-60 Propeller Tolerance (static rpm at maximum permissible throttle setting, Sea Level, ISA)	Not above 2430 RPM Not below 2330 RPM

**NOTE**

Refer to the airplane maintenance manual for test procedure to determine approved static rpm under non standard conditions.

**NOTE**

Refer to the airplane maintenance manual for test procedure to determine approved static rpm under non standard conditions.

**2.9 POWER PLANT INSTRUMENT MARKINGS**

(a) Tachometer	
Green Arc (Normal Operating Range)	500 to 2700 RPM
Red Line (Maximum Continuous Power)	2700 RPM
(b) Oil Temperature	
Green Arc (Normal Operating Range)	100° to 245°F
Red Line (Maximum)	245°F

**2.9 POWER PLANT INSTRUMENT MARKINGS (Continued)**

(c) Oil Pressure		
Green Arc (Normal Operating Range)		55 to 95 PSI
Yellow Arc (Caution Range) (Idle)		25 to 55 PSI
Yellow Arc (Ground Warm-Up)		95 to 115 PSI
Red Line (Minimum)		25 PSI
Red Line (Maximum)		115 PSI
(d) Fuel Pressure		
Green Arc (Normal Operating Range)		.5 to 8 PSI
Red Line (Minimum)		.5 PSI
Red Line (Maximum)		8 PSI
(e) Vacuum		
Red Line (Minimum)		4.8 in. Hg.
Green Arc (Normal Operating Range)	4.8 in. Hg. to	5.2 in. Hg.
Red Line (Maximum)		5.2 in. Hg.

**2.11 WEIGHT LIMITS**

	Normal	Utility
(a) Maximum Weight	2440 LBS	2020 LBS
(b) Maximum Ramp Weight	2447 LBS	2027 LBS
(c) Maximum Baggage	200 LBS	0 LBS

**NOTE**

Refer to Section 5 (Performance) for maximum weight as limited by performance.

**2.13 CENTER OF GRAVITY LIMITS****(a) Normal Category**

Weight Pounds	Forward Limit Inches Aft of Datum	Rearward Limit Inches Aft of Datum
2440	88.3	93.0
1950 (and less)	83.0	93.0

**(b) Utility Category**

Weight Pounds	Forward Limit Inches Aft of Datum	Rearward Limit Inches Aft of Datum
1950 (and less)	83.0	93.0
2020	83.8	93.0

**NOTES**

Straight line variation between points given.

The datum used is 78.4 inches ahead of the wing leading edge at the inboard intersection of the straight and tapered section.

It is the responsibility of the airplane owner and the pilot to insure that the airplane is properly loaded. See Section 6 (Weight and Balance) for proper loading instructions.

**2.15 MANEUVER LIMITS**

- (a) Normal Category - All acrobatic maneuvers including spins prohibited.
- (b) Utility Category - Approved Maneuvers for bank angles exceeding 60°:

	Entry Speed
Steep Turns	111 KIAS
Lazy Eights	111 KIAS
Chandelles	111 KIAS

**2.17 FLIGHT LOAD FACTORS**

	Normal	Utility
(a) Positive Load Factor (Maximum)	3.8 G	4.4 G
(b) Negative Load Factor (Maximum)	No inverted maneuvers approved	

**2.19 KINDS OF OPERATION EQUIPMENT LIST**

This airplane may be operated in day or night VFR, day or night IFR when the appropriate equipment is installed and operable.

The following equipment list identifies the systems and equipment upon which type certification for each kind of operation was predicated and must be installed and operable for the particular kind of operation indicated. However, certain operations may be authorized with certain listed equipment and/or systems inoperative under certain conditions and under provisions defined by a current Minimum Equipment List (MEL) approved by the FAA which is dated concurrently with or after this Pilot's Operating Handbook and FAA Approved Airplane Flight Manual and authorized under an operating regulation which provides for use of an MEL.

- (a) Day VFR
  - (1) Airspeed indicator
  - (2) Altimeter
  - (3) Magnetic compass
  - (4) Tachometer
  - (5) Oil pressure indicator
  - (6) Oil temperature indicator
  - (7) Fuel pressure indicator
  - (8) Fuel quantity indicator - each tank
  - (9) Volt-ammeter
  - (10) Elevator/rudder trim indicator
  - (11) Alternator
  - (12) Safety restraint - each occupant
- (b) Night VFR
  - (1) All equipment required for Day VFR
  - (2) Position lights
  - (3) Instrument lights
  - (4) Anti-collision (strobe) lights

- (c) Day IFR
  - (1) All equipment required for Day VFR
  - (2) Vacuum pump
  - (3) Gyro suction indicator
  
- (d) Night IFR
  - (1) All equipment required for Day and Night VFR
  - (2) All equipment required for Day IFR

**NOTE**

The above system and equipment list does not include specific flight instruments and communication/navigation equipment required by the FAR Part 91 and 135 operating requirements.

**2.21 FUEL LIMITATIONS**

- (a) Total Capacity 50 U.S. GAL.
- (b) Unusable Fuel 2 U.S. GAL.  
The unusable fuel for this airplane has been determined as 1.0 gallon in each wing in critical flight attitudes.
- (c) Usable Fuel 48 U.S. GAL.  
The usable fuel in this airplane has been determined as 24.0 gallons in each wing.

**2.25 PLACARDS**

In full view of the pilot:

THIS AIRPLANE MUST BE OPERATED AS A NORMAL OR UTILITY CATEGORY AIRPLANE IN COMPLIANCE WITH THE OPERATING LIMITATIONS STATED IN THE FORM OF PLACARDS, MARKINGS AND MANUALS.

ALL MARKINGS AND PLACARDS ON THIS AIRPLANE APPLY TO ITS OPERATION AS A UTILITY CATEGORY AIRPLANE. FOR NORMAL AND UTILITY CATEGORY OPERATION, REFER TO THE PILOT'S OPERATING HANDBOOK.

NO ACROBATIC MANEUVERS ARE APPROVED FOR NORMAL CATEGORY OPERATIONS. SPINS ARE PROHIBITED FOR NORMAL AND UTILITY CATEGORY.

In full view of the pilot and passengers: Serial Number 2842019 and Up

NO SMOKING

Adjacent to upper door latch:

ENGAGE LATCH BEFORE FLIGHT

On inside of the baggage compartment door:

BAGGAGE MAXIMUM 200 LBS  
UTILITY CATEGORY OPERATION — NO BAGGAGE  
OR AFT PASSENGERS ALLOWED. NORMAL  
CATEGORY OPERATION - SEE PILOT'S OPER-  
ATING HANDBOOK WEIGHT AND BALANCE  
SECTION FOR BAGGAGE AND AFT PASSENGER  
LIMITATIONS.

In full view of the pilot:

$V_A = 111$  KIAS AT 2440# (SEE POH)

DEMO. X-WIND 17 KTS.

NOTE

Demonstrated crosswind values are NOT  
limitations.

In full view of the pilot when the oil cooler winterization kit is installed:

OIL COOLER WINTERIZATION PLATE TO BE  
REMOVED WHEN AMBIENT TEMPERATURE  
EXCEEDS 50°F.

**SECTION 2  
LIMITATIONS**

**PIPER AIRCRAFT CORPORATION  
PA-28-161, WARRIOR III**

In full view of the pilot:

**UTILITY CATEGORY OPERATION ONLY**

- (1) NO AFT PASSENGERS ALLOWED.
- (2) ACROBATIC MANEUVERS ARE LIMITED TO THE FOLLOWING:

	ENTRY SPEED
SPINS PROHIBITED	
STEEP TURNS	111 KIAS
LAZY EIGHTS	111 KIAS
CHANDELLES	111 KIAS

In full view of the pilot:

WARNING = TURN OFF STROBE LIGHTS WHEN IN CLOSE PROXIMITY TO GROUND OR DURING FLIGHT THROUGH CLOUD, FOG OR HAZE.

Adjacent to fuel filler caps (serial numbers 28-8316037 and up):

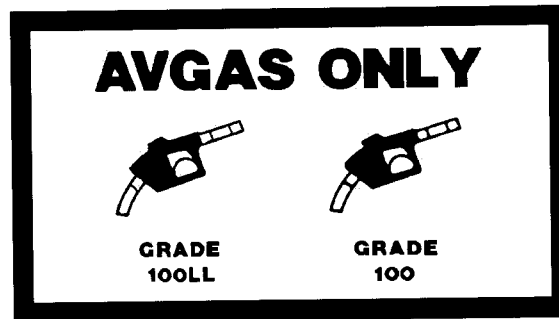



**TABLE OF CONTENTS**  
**SECTION 3**  
**EMERGENCY PROCEDURES**

Paragraph No.		Page No.
3.1	General .....	3-1
3.2	Airspeeds for Safe Operation .....	3-2
3.3	Emergency Procedures Checklist .....	3-3
	Engine Fire During Start .....	3-3
	Engine Power Loss During Takeoff .....	3-3
	Engine Power Loss In Flight .....	3-3
	Power Off Landing .....	3-4
	Fire In Flight .....	3-4
	Loss Of Oil Pressure .....	3-5
	Loss Of Fuel Pressure .....	3-5
	High Oil Temperature .....	3-5
	Electrical Failures .....	3-5
	Electrical Overload .....	3-5
	Spin Recovery .....	3-6
	Open Door .....	3-6
	Engine Roughness .....	3-7
	Carburetor Icing .....	3-7
3.5	Amplified Emergency Procedures (General) .....	3-9
3.7	Engine Fire During Start .....	3-9
3.9	Engine Power Loss During Takeoff .....	3-9
3.11	Engine Power Loss In Flight .....	3-10
3.13	Power Off Landing .....	3-11
3.15	Fire In Flight .....	3-11
3.17	Loss Of Oil Pressure .....	3-12
3.19	Loss Of Fuel Pressure .....	3-12
3.21	High Oil Temperature .....	3-13
3.23	Electrical Failures .....	3-13
3.24	Electrical Overload .....	3-14
3.25	Spin Recovery .....	3-15

## TABLE OF CONTENTS

### SECTION 3 (cont)

Paragraph No.		Page No.
3.27	Open Door .....	3-15
3.29	Carburetor Icing .....	3-15
3.31	Engine Roughness .....	3-16

**SECTION 3  
EMERGENCY PROCEDURES**

**3.1 GENERAL**

The recommended procedures for coping with various types of emergencies and critical situations are provided by this section. All of required (FAA regulations) emergency procedures and those necessary for operation of the airplane as determined by the operating and design features of the airplane are presented.

Emergency procedures associated with those optional systems and equipment which require handbook supplements are provided in Section 9 (Supplements).

The first portion of this section consists of an abbreviated emergency check list which supplies an action sequence for critical situations with little emphasis on the operation of systems.

The remainder of the section is devoted to amplified emergency procedures containing additional information to provide the pilot with a more complete understanding of the procedures.

These procedures are suggested as a course of action for coping with the particular condition described, but are not a substitute for sound judgement and common sense. Pilots should familiarize themselves with the procedures given in this section and be prepared to take appropriate action should an emergency arise.

Most basic emergency procedures, such as power off landings, are a normal part of pilot training. Although these emergencies are discussed here, this information is not intended to replace such training, but only to provide a source of reference and review, and to provide information on procedures which are not the same for all aircraft. It is suggested that the pilot review standard emergency procedures periodically to remain proficient in them.

**3.2 AIRSPEEDS FOR SAFE OPERATION**

**3.2a STALL SPEEDS**

2440 lbs (0° Flaps).....50-KIAS  
2440 lbs (Full Flaps).....44 KIAS

**3.2b MANEUVERING SPEEDS**

2440 lbs.....111 KIAS  
1531 lbs.....88 KIAS

**3.2c NEVER EXCEED SPEED**

Never Exceed Speed.....160 KIAS

**3.2c POWER OFF GLIDE SPEED**

2325 lbs (0° Flaps).....73 KIAS

**3.3 EMERGENCY PROCEDURES CHECKLIST**

**ENGINE FIRE DURING START**

Starter .....crank engine  
Mixture .....idle cut-off  
Throttle .....open  
Electric Fuel Pump .....OFF  
Fuel Selector .....OFF  
Abandon if fire continues

**ENGINE POWER LOSS DURING TAKEOFF**

If sufficient runway remains for a normal landing, land straight ahead.

If insufficient runway remains

Maintain safe airspeed

Make only shallow turn to avoid obstructions

Flaps as situation requires

If sufficient altitude has been gained to attempt a restart:

Maintain safe airspeed

Fuel Selector .....switch to tank  
containing fuel

Electric Fuel Pump.....check ON

Mixture .....check RICH

Carburetor Heat .....ON

If power is not regained, proceed with power off landing.

**ENGINE POWER LOSS IN FLIGHT**

Fuel Selector .....switch to tank  
containing fuel

Electric Fuel Pump .....ON

Mixture .....RICH

Carburetor Heat .....ON

Engine Gauges .....check for indication  
of cause of power loss

If no fuel pressure is indicated, check tank selector position to be sure it is on a tank containing fuel.

When power is restored:

Carburetor heater .....OFF

Electric fuel pump .....OFF

If power is not restored, prepare for power off landing.

Trim for 73 KIAS

**POWER OFF LANDING**

Locate suitable field.

Establish spiral pattern.

1000 ft. above field at downwind position for normal landing approach.

When field can easily be reached slow to 63 KIAS for shortest landing.

Touchdowns should normally be made at lowest possible airspeed with full flaps.

When committed to landing to landing:

Ignition .....OFF  
Battery Master switch .....OFF  
ALTR Switch .....OFF  
Fuel selector .....OFF  
Mixture .....idle cut-off  
Seat belts and harnesses .....tight

**FIRE IN FLIGHT**

**NOTE:**

The possibility of an engine fire in flight is extremely remote.

The procedure given is general and Pilot judgment should be the determining factor for action in such an emergency.

Source of fire .....check

Electrical fire (smoke in cabin):

Battery Master switch .....OFF  
ALTR Switch .....OFF  
Vents .....open  
Cabin heat .....OFF

Land as soon as practical.

Engine fire:

Fuel selector .....OFF  
Throttle .....CLOSED  
Mixture .....idle cut-off  
Electric fuel pump .....check OFF  
Heater .....OFF  
Defroster .....OFF

Proceed with POWER OFF LANDING procedure.

**LOSS OF OIL PRESSURE**

Land as soon as possible and investigate cause.  
Prepare for power off landing.

**LOSS OF FUEL PRESSURE**

Electric fuel pump .....ON  
Fuel selector .....check on tank  
containing fuel

**HIGH OIL TEMPERATURE**

Land at nearest airport and investigate the problem.  
Prepare for power off landing.

**ELECTRICAL FAILURES**

**NOTE:**

Anytime the bus voltage is below 25 Vdc, the Low  
Bus Voltage Annunciator will be illuminated.

ALT annunciator light illuminated:

Ammeter .....Check to verify inop. alt.

If ammeter shows zero:

ALT switch .....OFF

Reduce electrical loads to minimum:

ALT circuit breaker .....Check and reset  
as required

ALT switch .....ON

If power not restored:

ALT switch .....OFF

If alternator output cannot be restored, reduce electrical loads and land as soon as practical. Anticipate complete electrical failure. Duration of battery power will be dependent on electrical load and battery condition prior to failure.

**ELECTRICAL OVERLOAD (Alternator over 20 amps above known electrical load)**

ALT switch .....ON  
Battery Master switch .....OFF  
If alternator loads are reduced:  
Electrical load .....Reduce to Minimum

Land as soon as practical.

**NOTE**

Due to increased system voltage and radio frequency noise, operation with ALT switch ON and BATT switch OFF should be made only when required by an electrical system failure.

If alternator loads are not reduced:

ALT switch .....OFF  
BATT switch .....As required

Land as soon as possible. Anticipate complete electrical failure.

**SPIN RECOVERY**

Rudder .....full opposite to  
direction of rotation  
Control wheel .....full forward while  
neutralizing ailerons  
Throttle .....idle  
Rudder .....neutral (when rotation stops)  
Control wheel .....as required to smoothly  
regain level flight attitude



**OPEN DOOR**

If both upper and lower latches are open, the door will trail slightly open and airspeeds will be reduced slightly.

To close the door in flight:

Slow airplane to 89 KIAS

Cabin vents .....close

Storm window .....open

If upper latch is open .....latch

If side latch if open.....pull on arm rest while  
moving latch handle to  
latched position.

If both latches are open .....latch side latch  
then top latch.

**ENGINE ROUGHNESS**

Carburetor Heat .....ON

If roughness continues after one min:

Carburetor Heat .....OFF

Mixture.....adjust for max.  
smoothness

Electric Fuel Pump .....ON

Fuel Selector.....switch tanks

Engine Gauges .....check

Magneto Switch .....L then R  
then BOTH

If operation is satisfactory on either magneto, continue on that magneto at reduced power and full RICH mixture to first airport.

Prepare for power off landing.

**CARBURETOR ICING**

Carburetor Heat .....ON

Mixture.....adjust for max.  
smoothness

**THIS PAGE INTENTIONALLY LEFT BLANK**

**3.5 AMPLIFIED EMERGENCY PROCEDURES (GENERAL)**

The following paragraphs are presented to supply additional information for the purpose of providing the pilot with a more complete understanding of the recommended course of action and probable cause of an emergency situation.

**3.7 ENGINE FIRE DURING START**

Engine fires during start are usually the result of overpriming. The first attempt to extinguish the fire is to try to start the engine and draw the excess fuel back into the induction system.

If a fire is present before the engine has started, move the mixture control to idle cut-off, open the throttle and crank the engine. This is an attempt to draw the fire back into the engine.

If the engine has started, continue operating to try to pull the fire into the engine.

In either case (above), if fire continues more than a few seconds, the fire should be extinguished by the best available external means.

The fuel selector valves should be OFF and the mixture at idle cut-off if an external fire extinguishing method is to be used.

**3.9 ENGINE POWER LOSS DURING TAKEOFF**

The proper action to be taken if loss of power occurs during takeoff will depend on the circumstances of the particular situation.

If sufficient runway remains to complete a normal landing, land straight ahead.

If insufficient runway remains, maintain a safe airspeed and make only a shallow turn if necessary to avoid obstructions. Use of flaps depends on the circumstances. Normally, flaps should be fully extended for touchdown.

If sufficient altitude has been gained to attempt a restart, maintain a safe airspeed and switch the fuel selector to another tank containing fuel. Check the electric fuel pump to ensure that it is ON and that the mixture is RICH. The carburetor heat should be ON.

If engine failure was caused by fuel exhaustion, power will not be regained after switching fuel tanks until the empty fuel lines are filled. This may require up to ten seconds.

If power is not regained, proceed with the Power Off Landing procedure (refer to the emergency check list and paragraph 3.13).

### **3.11 ENGINE POWER LOSS IN FLIGHT**

Complete engine power loss is usually caused by fuel flow interruption, and power will be restored shortly after fuel flow is restored. If power loss occurs at a low altitude, the first step is to prepare for an emergency landing (refer to paragraph 3.13). An airspeed of at least 73 KIAS should be maintained.

If altitude permits, switch the fuel selector to another tank containing fuel and turn the electric fuel pump ON. Move the mixture control to RICH and the carburetor heat to ON. Check the engine gauges for an indication of the cause of the power loss. If no fuel pressure is indicated, check the tank selector position to be sure it is on a tank containing fuel.

When power is restored move the carburetor heat to the OFF position and turn OFF the electric fuel pump.

If the preceding steps do not restore power, prepare for an emergency landing.

If time permits, turn the magneto switch to L then to R then back to BOTH. Move the throttle and mixture control levers to different settings. This may restore power if the problem is too rich or too lean a mixture or if there is a partial fuel system restriction. Try other fuel tanks. Water in the fuel could take some time to be used up, and allowing the engine to windmill may restore power. If power loss is due to water, fuel pressure indications will be normal.

If engine failure was caused by fuel exhaustion, power will not be restored after switching fuel tanks until the empty fuel lines are filled. This may required up to ten seconds.

If power is not regained, proceed with the Power Off Landing procedure (refer to the emergency checklist and paragraph 3.13).

### **3.13 POWER OFF LANDING**

If loss of power occurs at altitude, trim the aircraft for best gliding angle (73 KIAS) and look for a suitable field. If measures taken to restore power are not effective, and if time permits, check your charts for airports in the immediate vicinity; it may be possible to land at one if you have sufficient altitude. If possible, notify the FAA by radio of your difficulty and intentions. If another pilot or passenger is aboard, let him help.

When you have located a suitable field, establish a spiral pattern around this field. Try to be at 1000 feet above the field at the downwind position to make a normal landing approach. When the field can easily be reached, slow to 63 KIAS for the shortest landing. Excess altitude may be lost by widening your pattern, using flaps or slipping, or a combination of these.

Touchdown should normally be made at the lowest possible airspeed.

When committed to a landing, lower the flaps as desired, close the throttle, move the mixture to idle cut-off, and shut OFF the magnetos. Turn the battery master and alternator switches OFF. Move the fuel selector valve to OFF. The seat belts and shoulder harness should be tightened.

### **3.15 FIRE IN FLIGHT**

The presence of fire is noted through smoke, smell and heat in the cabin. It is essential that the source of the fire be promptly identified through instrument readings, characteristics of the smoke, or other indications since the action to be taken differs somewhat in each case.

Check for the source of the fire first.

If an electrical fire is indicated (smoke in the cabin), the battery master switch should be turned OFF. The cabin vents should be opened and the cabin heat turned OFF. A landing should be made as soon as possible.

If an engine fire is present, switch the fuel selector to OFF and close the throttle. The mixture should be at idle cut-off. Turn the electric fuel pump OFF. In all cases, the heater and defroster should be OFF. If radio communication is not required, select battery master and alternator switches OFF. Proceed with power off landing procedure.

**NOTE::**

The possibility of an engine fire in flight is extremely remote. The procedure given is general and pilot judgement should be the determining factor for action in such an emergency.

**3.17 LOSS OF OIL PRESSURE**

Loss of oil pressure may be either partial or complete. A partial loss of oil pressure usually indicates a malfunction in the oil pressure regulating system, and a landing should be made as soon as possible to investigate the cause and prevent engine damage.

A complete loss of oil pressure indication may signify oil exhaustion or may be the result of a faulty gauge. In either case, proceed toward the nearest airport, and be prepared for a forced landing. If the problem is not a pressure gauge malfunction, the engine may stop suddenly. Maintain altitude until such time as a dead stick landing can be accomplished. Don't change power settings unnecessarily, as this may hasten complete power loss.

Depending on the circumstances, it may be advisable to make an off airport landing while power is still available, particularly if other indications of actual oil pressure loss, such as sudden increases in temperatures, or oil smoke, are apparent, and an airport is not close.

If engine stoppage occurs, proceed with a Power Off Landing.

**3.19 LOSS OF FUEL PRESSURE**

The most probable cause of loss of fuel pressure is either fuel depletion in the fuel tank selected or failure of the engine driven fuel pump. If loss of fuel pressure occurs, turn ON the electric fuel pump and check that the fuel selector is on a tank containing usable fuel.

If loss of fuel pressure is due to failure of the engine driven fuel pump the electric fuel pump will supply sufficient fuel pressure.

**3.19 LOSS OF FUEL PRESSURE (CONT'D)**

After fuel pressure and power are regained, turn the electric fuel pump OFF. If fuel pressure starts to drop, turn the electric fuel pump ON and land at the nearest suitable airport as soon as possible and have the cause investigated.

**CAUTION**

If normal engine operation and fuel pressure is not immediately re-established, the electric fuel pump should be turned off. The lack of fuel pressure indication could indicate a leak in the fuel system, or fuel exhaustion.

**3.21 HIGH OIL TEMPERATURE**

An abnormally high oil temperature indication may be caused by a low oil level, an obstruction in the oil cooler, damaged or improper baffle seals, a defective gauge, or other causes. Land as soon as practical at an appropriate airport and have the cause investigated.

A steady, rapid rise in oil temperature is a sign of trouble. Land at the nearest airport and let a mechanic investigate the problem. Watch the oil pressure gauge for an accompanying loss of pressure.

**3.23 ELECTRICAL FAILURES****NOTE:**

Anytime the bus voltage is below 25 Vdc, the Low Bus Voltage Annunciator will be illuminated.

Loss of alternator output is detected through zero reading on the ammeter and alternator inop annunciator. Before executing the following procedure, ensure that the reading is zero, and not merely low, by actuating an electrically powered device, such as the landing light. If no increase in the ammeter reading is noted, alternator failure can be assumed.

The electrical load should be reduced as much as possible. Check for an open alternator field circuit breaker.

Next attempt to reset the overvoltage relay by moving the ALTR switch to OFF for one second and then to ON. If the trouble was caused by a momentary overvoltage condition (30.5 volts and up) this procedure should return the ammeter to a normal reading.

**3.23 ELECTRICAL FAILURES (CONT'D)**

**NOTE:**

Low Bus Voltage Annunciator and Alternator  
Inop. Annunciator will be illuminated.

If the ammeter continues to indicate ZERO output, or if the alternator will not remain reset, turn off the ALTR switch, maintain minimum electrical load and land as soon as practical. Anticipate complete electrical failure. Duration of battery power will be dependent on electrical load and battery condition prior to failure.

**3.24 ELECTRICAL OVERLOAD (Alternator over 20 amps above known electrical load)**

If abnormally high alternator output is observed (more than 20 amps above known electrical load for the operating conditions), it may be caused by a low battery, a battery fault or other abnormal electrical load. If the cause is a low battery, the indication should begin to decrease toward normal within 5 minutes. If the overload condition persists, attempt to reduce the load by turning off non-essential equipment.

Turn the BATT switch OFF and the ammeter should decrease. Turn the BATT switch ON and continue to monitor the ammeter. If the alternator output does not decrease within 5 minutes, turn the BATT switch OFF and land as soon as possible. All electrical loads are being supplied by the alternator.

**NOTE**

Due to higher voltage and radio frequency noise, operation with the ALT switch ON and the BATT switch OFF should be made only when required by an electrical failure.



**3.25 SPIN RECOVERY**

Intentional spins are prohibited in this airplane. If a spin is inadvertently entered, immediately apply full rudder opposite to the direction of rotation. Move the control wheel full forward while neutralizing the ailerons. Move the throttle to IDLE. When the rotation stops, neutralize the rudder and ease back on the control wheel as required to smoothly regain a level flight attitude.

**3.27 OPEN DOOR**

The cabin door on the Cherokee is double latched, so the chance of it springing open in flight at both the top and side are remote. However, should you forget the upper latch, or not fully engage the side latch, the door may spring partially open. This will usually happen at takeoff or soon afterward. A partially open door will not affect normal flight characteristics, and a normal landing can be made with the door open.

If both upper and side latches are open, the door will trail slightly open, and airspeed will be reduced slightly.

To close the door in flight, slow the airplane to 89 KIAS, close the cabin vents and open the storm window. If the top latch is open, latch it. If the side latch is open, pull on the arm rest while moving the latch handle to the latched position. If both latches are open, close the side latch then the top latch.

**3.29 CARBURETOR ICING**

Under certain moist atmospheric conditions at temperatures of -5°C to 20°C, it is possible for ice to form in the induction system, even in summer weather. This is due to the high air velocity through the carburetor venturi and absorption of heat from this air by vaporization of the fuel.

To avoid this, carburetor preheat is provided to replace the heat lost by vaporization. Carburetor heat should be full on when carburetor ice is encountered. Adjust mixture for maximum smoothness.

**3.31 ENGINE ROUGHNESS**

Engine roughness is usually due to carburetor icing which is indicated by a drop in RPM, and may be accompanied by a slight loss of airspeed or altitude. If too much ice is allowed to accumulate, restoration of full power may not be possible; therefore, prompt action is required.

Turn carburetor heat on (see Note). RPM will decrease slightly and roughness will increase. Wait for a decrease in engine roughness or an increase in RPM, indicating ice removal. If there is no change in approximately one minute, return the carburetor heat to OFF.

If the engine is still rough, adjust the mixture for maximum smoothness. The engine will run rough if the mixture is too rich or too lean. The electric fuel pump should be switched to ON and the fuel selector switched to the other tank to see if fuel contamination is the problem. Check the engine gauges for abnormal readings. If any gauge readings are abnormal, proceed accordingly. Move the magneto switch to L then to R, then back to BOTH. If operation is satisfactory on either magneto, proceed on that magneto, at reduced power, with mixture full RICH, to a landing at the first available airport.

If roughness persists, prepare for a precautionary landing at pilot's discretion.

**NOTE**

Partial carburetor heat may be worse than no heat at all, since it may melt part of the ice which will refreeze in the intake system. Therefore when using carburetor heat always use full heat; and, when ice is removed, return the control to the full cold position.

## TABLE OF CONTENTS

### SECTION 4

#### NORMAL PROCEDURES

Paragraph No.		Page No.
4.1	General .....	4-1
4.3	Airspeeds For Safe Operations .....	4-2
4.5	Normal Procedures Check List .....	4-3
	Preparation .....	4-3
	Preflight Check .....	4-4
	Before Starting Engine .....	4-6
	Starting Engine When Cold .....	4-6
	Starting Engine When Hot .....	4-6
	Starting Engine When Flooded .....	4-7
	Starting With External Power Source .....	4-7
	Warm-Up .....	4-7
	Taxiing .....	4-7
	Ground Check .....	4-8
	Before Takeoff .....	4-8
	Takeoff .....	4-9
	Climb .....	4-10
	Cruising .....	4-10
	Descent .....	4-10
	Approach And Landing .....	4-11
	Stopping Engine .....	4-11
	Parking .....	4-11
4.7	Amplified Normal Procedures (General) .....	4-12
4.9	Preflight Check .....	4-12
4.11	Before Starting Engine .....	4-15
4.13	Starting Engine .....	4-15
4.15	Warm-Up .....	4-17
4.17	Taxiing .....	4-18
4.19	Ground Check .....	4-18

## TABLE OF CONTENTS

### SECTION 4 (cont)

Paragraph No.	Page No.
4.21 Before Takeoff.....	4-19
4.23 Takeoff.....	4-20
4.25 Climb.....	4-21
4.27 Cruising.....	4-21
4.29 Descent.....	4-22
4.31 Approach And Landing.....	4-23
4.33 Stopping Engine.....	4-24
4.35 Parking.....	4-24
4.37 Stalls.....	4-25
4.39 Turbulent Air Operation.....	4-25
4.41 Weight And Balance.....	4-25
4.43 Noise Levels.....	4-26

**SECTION 4  
NORMAL PROCEDURES**

**4.1 GENERAL**

This section describes the recommended procedures for the conduct of normal operations for the WARRIOR III. All of the required (FAA regulations) procedures and those necessary for operation of the airplane as determined by the operating and design features of the airplane are presented.

Normal procedures associated with those optional systems and equipment which require handbook supplements are provided by Section 9 (Supplements).

These procedures are provided to present a source of reference and review and to supply information on procedures which are not the same for all aircraft. Pilots should familiarize themselves with the procedures given in this section in order to become proficient in the normal operations of the airplane.

The first portion of this section consists of a short form checklist which supplies an action sequence for normal operations with little emphasis on the operation of the systems.

The remainder of the section is devoted to amplified normal procedures which provide detailed information and explanations of the procedures and how to perform them. This portion of the section is not intended for use as an in-flight reference due to the lengthy explanations. The short form checklist should be used for this purpose.

**4.3 AIRSPEEDS FOR SAFE OPERATIONS**

The following airspeeds are those which are significant to the operation of the airplane. These figures are for standard airplanes flown at gross weight under standard conditions at sea level.

Performance for a specific airplane may vary from published figures depending upon the equipment installed; the condition of the engine, airplane and equipment; atmospheric conditions and piloting technique.

(a) Best Rate of Climb Speed	79 KIAS
(b) Best Angle of Climb Speed	63 KIAS
(c) Turbulent Air Operating Speed (See Subsection 2.3)	111 KIAS
(d) Maximum Flap Speed	103 KIAS
(e) Landing Final Approach Speed (Flaps 40°)	63 KIAS
(f) Maximum Demonstrated Crosswind Velocity	17 KTS

**WALK-AROUND**

Figure 4-1

**4.5 NORMAL PROCEDURES CHECKLIST****PREPARATION**

Airplane status.....airworthy, papers on board  
 Weather.....suitable  
 Baggage.....weighed, stowed, tied  
 Weight and C.G.....within limits  
 Navigation.....planned  
 Charts and navigation equipment.....on board  
 Performance and range.....computed and safe

**PREFLIGHT CHECK**

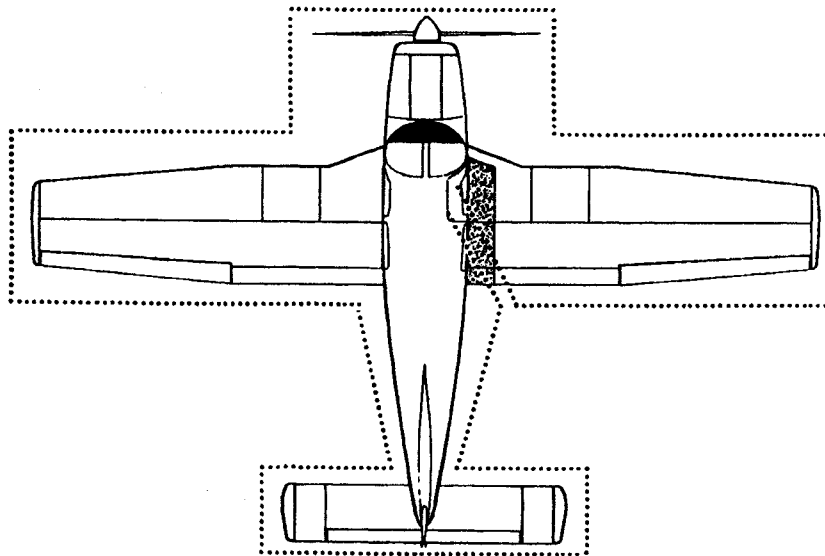
**COCKPIT**

Control wheel .....release belts  
Avionics .....OFF  
Parking brake .....Set  
Electric switches .....OFF  
Magneto switch.....OFF  
Mixture .....idle cut-off  
Master switch .....ON  
Fuel quantity gauges .....check  
Annunciator panel.....check  
Master switch.....OFF  
Flight controls.....check  
Flaps.....check  
Trim .....check, set neutral  
Pitot drain .....DRAIN, close  
Static drain .....DRAIN, close  
Windows.....check, clean  
Tow bar .....stow  
Baggage .....secure  
Baggage door.....close, secure

**RIGHT WING**

Wing .....free of ice, snow, frost  
Control surfaces.....check for interference -  
free of ice, snow, frost  
Hinges .....check for interference  
Static wicks.....check  
Wing tip and lights.....check  
Fuel tank.....check supply  
visually - secure caps  
Fuel tank sump .....drain, check for water,  
sediment and proper fuel  
Fuel vent .....clear  
Tie down and chock .....remove  
Main gear strut.....proper  
inflation (4.50 in.)  
Tire .....check  
Brake block and discs .....check  
Fresh air inlet.....clear





**SECTION 4**  
**NORMAL PROCEDURES**

**PA-28-161, WARRIOR III**

Fresh air inlet.....clear  
Stabilator and trim tab.....check for interference  
Tie down.....remove  
Master switch .....ON  
Cockpit lighting .....check  
Nav and strobe lights .....check  
Stall warning .....check  
Pitot heat .....check  
All switches .....OFF  
Passengers .....board  
Cabin door.....close and secure  
Seat belts and harnesses .....fasten - check  
interia reel

**BEFORE STARTING ENGINE**

Brakes .....set  
Circuit Breakers.....check IN  
Carburetor Heat .....full OFF  
Fuel Selector .....desired tank  
Radios .....OFF

**STARTING ENGINE WHEN COLD**

Throttle .....1/4" open  
Master switch .....ON  
Alternator switch .....ON  
Electric fuel pump .....ON  
Mixture.....full RICH  
Propeller.....CLEAR  
Starter.....engage  
Throttle .....adjust  
Oil Pressure.....check

If engine does not start within 10 sec., prime and repeat starting procedure.

**STARTING ENGINE WHEN HOT**

Throttle .....1/2" open  
Master Switch.....ON  
Alternator switch .....ON  
Electric fuel pump .....ON  
Mixture.....full RICH  
Propeller.....CLEAR  
Starter.....engage

Throttle .....adjust  
Oil pressure .....check

**STARTING ENGINE WHEN FLOODED**

Throttle .....open full  
Master switch .....ON  
Alternator switch .....ON  
Electric fuel pump .....OFF  
Mixture .....idle cut-off  
Propeller .....CLEAR  
Starter .....engage  
Mixture .....advance  
Throttle .....retard  
Oil pressure .....check

**STARTING ENGINE WITH EXTERNAL POWER SOURCE**

Master switch .....OFF  
Alternator switch .....OFF  
All electrical equipment .....OFF  
External power plug .....insert in  
fuselage  
Proceed with normal start checklist, then:  
Throttle .....lowest possible  
RPM  
External power plug .....disconnect from  
fuselage

**WARM-UP**

Throttle .....800 to 1200 RPM

**TAXIING**

Chocks .....removed  
Taxi area .....clear  
Throttle .....apply slowly  
Brakes .....check  
Steering .....check



**TAKEOFF**

**NORMAL**

Flaps.....set  
Trim .....set  
Accelerate to 45 to 55 KIAS  
Control wheel .....back pressure to  
rotate to climb attitude

**0° FLAPS TAKEOFF PERFORMANCE**

Flaps.....UP  
Accelerate to 40-52 KIAS (depending on weight)  
Control Wheel .....back pressure to  
rotate to climb attitude  
Accelerate to and maintain 44 to 57 KIAS (depending on weight) until  
obstacle clearance is achieved and climb out at 79 KIAS.

**25° FLAPS TAKEOFF PERFORMANCE**

Flaps.....25° (second notch)  
Accelerate to 40-52 KIAS (depending on weight)  
Control Wheel .....back pressure to  
rotate to climb attitude  
Accelerate to and maintain 44 to 57 KIAS (depending on weight) until  
obstacle clearance is achieved and climb out at 79 KIAS.  
Flaps .....retract slowly

**SOFT FIELD, OBSTACLE CLEARANCE**

Flaps.....25° (second notch)  
Accelerate and lift off nose gear as soon as possible. Lift off at lowest  
possible airspeed. Accelerate just above ground to 52 KIAS to climb past  
obstacle height. Continue climbing while accelerating to best rate of climb  
speed, 79 KIAS.  
Flaps .....retract slowly

**SECTION 4**  
**NORMAL PROCEDURES**

**PA-28-161, WARRIOR III**

**SOFT FIELD, NO OBSTACLE**

Flaps.....25° (second notch)  
Accelerate and lift off nose gear as soon as possible. Lift off at lowest possible airspeed. Accelerate just above ground to best rate of climb speed, 79 KIAS.  
Flaps .....retract slowly

**CLIMB**

Best rate (flaps up).....79 KIAS  
Best angle (flaps up) .....63 KIAS  
En route.....87 KIAS  
Electric fuel pump.....OFF at  
desired altitude

**CRUISING**

Reference performance charts and Avco-Lycoming Operators Manual.  
Normal max power .....75%  
Power .....set per power table  
Mixture .....adjust

**DESCENT**

**NORMAL**

Throttle .....2500 rpm  
Airspeed.....126 KIAS  
Mixture.....rich  
Carburetor heat .....ON if required

**POWER OFF**

Carburetor heat .....ON if required  
Throttle.....close  
Airspeed.....as required  
Mixture .....as required  
Power.....verify with throttle every 30 seconds

**APPROACH AND LANDING**

Fuel selector .....proper tank  
 Seat backs .....erect  
 Belts/harness .....fasten/check  
 Electric fuel pump .....ON  
 Mixture .....set  
 Flaps .....set - 103 KIAS max  
 Trim to 70 KIAS  
 Final approach speed (flaps 40°) .....63 KIAS

**STOPPING ENGINE**

Flaps .....retract  
 Electric fuel pump .....OFF  
 Radios .....OFF  
 Throttle .....full aft  
 Mixture .....idle cut-off  
 Magnetos .....OFF  
 Alternator switch .....OFF  
 Master switch .....OFF

**PARKING**

Parking brake .....set  
 Control wheel .....secure with belts  
 Flaps .....full up  
 Wheel chocks .....in place  
 Tie downs .....secure

#### 4.7 AMPLIFIED NORMAL PROCEDURES (GENERAL)

The following paragraphs are provided to supply detailed information and explanations of the normal procedures necessary for the safe operation of the airplane.

#### 4.9 PREFLIGHT CHECK

##### PREPARATION

The airplane should be given a thorough preflight and walk-around check. The preflight should include a check of the airplane's required papers, operational status, computation of weight and C.G. limits, takeoff and landing distances, and in-flight performance. A weather briefing should be obtained for the intended flight path, and any other factors relating to a safe flight should be checked before takeoff.

##### *CAUTION*

The flap position should be noted before boarding the airplane. The flaps must be placed in the UP position before they will lock and support weight on the step.

##### COCKPIT

Upon entering the cockpit, release the seat belts securing the control wheel, turn OFF all avionics equipment, and set the parking brake. Insure that all electrical switches and the magneto switch are OFF and that the mixture is in idle cut-off. Turn ON the master switch, check the fuel quantity gauges for adequate supply and check that the annunciator panel illuminates. Turn OFF the master switch. Check the primary flight controls and flaps for proper operation and set the trim to neutral. Open the pitot and static drains to remove any moisture that has accumulated in the lines. Check the windows for cleanliness. Properly stow the tow bar and baggage and secure. Close and secure the baggage door.



**RIGHT WING**

Begin the walk-around at the trailing edge of the right wing by checking that the wing surface and control surfaces are clear of ice, frost, snow or other extraneous substances. Check the flap, aileron and hinges for damage and operational interference. Static wicks should be firmly attached and in good condition. Check the wing tip and lights for damage.

Open the fuel cap and visually check the fuel color and the quantity should match the indication that was on the fuel quantity gauge, replace cap securely. The fuel tank vent should be clear of obstructions.

Drain the fuel tank through the quick drain located at the lower inboard rear corner of the tank, making sure that enough fuel has been drained to insure that all water and sediment is removed. The fuel system should be drained daily prior to the first flight and after each refueling and checked for proper fuel.

**CAUTION**

When draining any amount of fuel, care should be taken to insure that no fire hazard exists before starting engine.

Remove the tie down and chock.

Next, a check of the landing gear. Check the gear strut for proper inflation; there should be  $4.50 \pm .25$  inches of strut exposure under a normal static load. Check the tire for cuts, wear, and proper inflation. Make a visual check of the brake block and disc.

Check that the fresh air inlet is clear of foreign matter.

**NOSE SECTION**

Check the general condition of the nose section, look for oil or fluid leakage and that the cowling is secure. Check the windshield and clean if necessary. The propeller and spinner should be checked for detrimental nicks, cracks, or other defects. The air inlets should be clear of obstructions and check the alternator belt for proper tension. The landing light should be clean and intact.

Remove the chock and check the nose gear strut for proper inflation, there should be  $3.25 \pm .25$  inches of strut exposure under a normal static load. Check the tire for cuts, wear, and proper inflation. Check the engine baffle seals. Check the oil level, make sure that the dipstick has been properly seated.

Open the fuel strainer located on the left side of the firewall long enough to remove any accumulation of water and sediment and check for proper fuel.

#### **LEFT WING**

The wing surface should be clear of ice, frost, snow, or other extraneous substances. Check that the fresh air inlet is clear of foreign matter and remove the chock. Check the main gear strut for proper inflation, there should be  $4.50 \pm .25$  inches of strut exposure under a normal static load. Check the tire and the brake block and disc.

Open the fuel cap and visually check the fuel color. The quantity should match the indication on the fuel quantity gauge. Replace cap securely. The fuel tank vent should be clear of obstructions. Drain enough fuel to insure that all water and sediment has been removed and check for proper fuel.

Remove tie down and chock. Remove the cover from the pitot/static head on the underside of the wing. Make sure the holes are open and clear of obstructions. Check the wing tip and lights for damage. Check the aileron, flap, and hinges for damage and operational interference and that the static wicks are firmly attached and in good condition.

#### **FUSELAGE**

Check the condition and security of the antennas. The empennage should be clear of ice, frost, snow, or other extraneous substances, and the fresh air inlet on the side of fuselage should be clear of foreign matter. Check the stabilator and trim tab for damage and operational interference. The trim tab should move in the same direction as the stabilator. Remove the tie down.

Upon returning to the cockpit, an operational check of the interior lights, exterior lights, stall warning system, and pitot heat should now be made. Turn the battery master switch and other appropriate switches ON. Check the panel lighting and the overhead flood light. Visually confirm that exterior lights are operational. Lift the stall detector on the leading edge of the left

wing and determine that the warning horn is activated. With the pitot heat switch ON, the pitot head will be hot to the touch. After these checks are complete, the master switch and all electrical switches should be turned OFF.

Board the passengers and close and secure the cabin door. Fasten the seat belts and shoulder harnesses. Pull test the locking restraint feature of the shoulder harness inertia reel. Fasten seat belts on empty seats.

#### **4.11 BEFORE STARTING ENGINE**

Before starting the engine, the brakes should be set by pulling back on the brake handle and depressing the knob attached to the left side of the handle. Check that all circuit breakers are IN. The carburetor heat lever should be moved to the full OFF position and the fuel selector should be moved to the desired tank. Check to make sure that all the radios are OFF.

#### **4.13 STARTING ENGINE**

##### **(a) Starting Engine When Cold**

Open the throttle lever approximately 1/4 inch. Turn ON the master switch, alternator switch and the electric fuel pump.

Move the mixture control to full RICH. Verify the area around the propeller is clear then engage the starter by rotating the magneto switch clockwise. When the engine fires, release the magneto switch, and move the throttle to the desired setting.

Check for proper oil pressure indication.

If the engine does not fire within five to ten seconds, disengage the starter, prime the engine and repeat the starting procedure (priming is accomplished by lifting the switch guard and depressing the momentary electric prime button for the desired time.)

(b) Starting Engine When Hot

Open the throttle approximately 1/2 inch. Turn ON the master switch, alternator switch and the electric fuel pump. Move the mixture control lever to full RICH. Verify the area around the propeller is clear then engage the starter by rotating the magneto switch clockwise. When the engine fires, release the magneto switch, and move the throttle to the desired setting.

Check for proper oil pressure indication.

(c) Starting Engine When Flooded

The throttle lever should be full OPEN. Turn ON the master switch and alternator switch, and turn OFF the electric fuel pump. Move the mixture control lever to idle cut-off. Verify the area around the propeller is clear then engage the starter by rotating the magneto switch clockwise. When the engine fires, release the magneto switch, advance the mixture and retard the throttle.

Check for proper oil pressure indication.

(d) Starting Engine With External Power Source

An External Power receptacle allows the operator to use an external battery to crank the engine without having to gain access to the airplane's battery.

Turn the master and alternator switches OFF and turn all electrical equipment OFF. Insert the plug of a 28 volt DC aux power jumper cable into the socket located on the fuselage. Note that when the plug is inserted, the electrical system is ON.

Proceed with the appropriate STARTING ENGINE checklist from paragraph 4.5.

After the engine has started reduce power to the lowest possible RPM, to reduce sparking, and disconnect the jumper cable from the aircraft. Check the alternator ammeter for an indication of output. **DO NOT ATTEMPT FLIGHT IF THERE IS NO INDICATION OF ALTERNATOR OUTPUT.**

Check for proper oil pressure indication.

**NOTE**

For all normal operations using the Aux Power jumper cables, the master switch and alternator switch should be OFF, but it is possible to use the ship's battery in parallel by turning the master switch and alternator switch ON. This will give longer cranking capabilities, but will not increase the amperage.

**CAUTION**

Care should be exercised, because, if the ship's battery has been depleted, the external power supply can be reduced to the level of the ship's battery. This can be tested by turning the master switch and alternator switch ON momentarily while the starter is engaged. If cranking speed increases, the ship's battery is at a higher level than the external power supply.

When the engine is firing evenly, advance the throttle to 800 rpm. If oil pressure is not indicated within thirty seconds, stop the engine and determine the trouble. In cold weather it will take a few seconds longer to get an oil pressure indication. If the engine has failed to start, refer to the Lycoming Operating Handbook, Engine Troubles and Their Remedies.

Starter manufacturer recommends starter cranking periods be limited to 10 seconds with a 20 second rest period between cranking periods. Maximum of 6 start periods allowed. If start is not achieved on sixth attempt allow starter to cool for 30 minutes before attempting additional starts..

**4.15 WARM-UP**

Warm-up the engine at 800 to 1200 RPM for not more than two minutes in warm weather and four minutes in cold. Avoid prolonged idling at low RPM, as this practice may result in fouled spark plugs.

Takeoff may be made as soon as the ground check is completed, provided that the throttle may be opened fully without backfiring or skipping, and without a reduction in engine oil pressure.

Do not operate the engine at high rpm when running up or taxiing over ground containing loose stones, gravel or any loose material that may cause damage to the propeller blades.

#### **4.17 TAXIING**

Before attempting to taxi the airplane, ground personnel should be instructed and approved by a qualified person authorized by the owner. Ascertain that the propeller back blast and taxi areas are clear.

Power should be applied slowly to start the taxi roll. Taxi a few feet forward and apply the brakes to determine their effectiveness. While taxiing, make slight turns to ascertain the effectiveness of the steering.

Observe wing clearances when taxiing near buildings or other stationary objects. If possible, station an observer outside the airplane.

Avoid holes and ruts when taxiing over uneven ground.

Do not operate the engine at high rpm when running up or taxiing over ground containing loose stones, gravel or any loose material that may cause damage to the propeller blades.

#### **4.19 GROUND CHECK**

The magnetos should be checked at 2000 RPM. Drop off on either magneto should not exceed 175 RPM and the difference between the magnetos should not exceed 50 RPM. Operation on one magneto should not exceed 10 seconds.

Check the vacuum gauge; the indicator should read 4.8" to 5.2" Hg at 2000 RPM.

Check the annunciator panel lights with the press-to-test button.

Carburetor heat should also be checked prior to takeoff to be sure the control is operating properly and to clean any ice which may have formed during taxiing. Avoid prolonged ground operation with carburetor heat ON as the air is unfiltered.

The electric fuel pump should be turned OFF after starting or during warm-up to make sure that the engine driven pump is operating. Check both oil temperature and oil pressure. The temperature may be low for some time if the engine is being run for the first time of the day. The engine is warm enough for takeoff when the throttle can be opened without the engine faltering.

#### **4.21 BEFORE TAKEOFF**

All aspects of each particular takeoff should be considered prior to executing the takeoff procedure.

Insure that the master and alternator switches are ON. Check and set all of the flight instruments as required. Check the fuel selector to make sure it is on the proper tank (fullest). Turn ON the electric fuel pump to prevent loss of power should the engine driven pump fail during takeoff, and check the engine gauges. The carburetor heat should be in the OFF position.

All seat backs should be erect and the seat belts and shoulder harness should be fastened. Pull test the locking restraint feature of the shoulder harness inertia reel. Fasten the seat belts snugly around the empty seats.

The mixture should be set.

#### **NOTE**

The mixture should be set FULL RICH, but a minimum amount of leaning is permitted for smooth engine operation when taking off at high elevation.

Exercise and set the flaps and trim tab. Insure proper flight control movement and response. The door should be properly secured and latched.

**4.23 TAKEOFF (See charts in Section 5)**

The normal takeoff technique is conventional. The trim should be set slightly aft of neutral, with the exact setting determined by the loading of the airplane. Allow the airplane to accelerate to 45 to 55 KIAS depending on the weight of the aircraft and ease back on the control wheel to rotate to climb attitude. Premature raising of the nose or raising it to an excessive angle will result in a delayed takeoff. After takeoff, let the airplane accelerate to the desired climb speed by lowering the nose slightly.

Takeoffs are normally made with flaps up; however, for short field takeoffs and for takeoffs under difficult conditions, such as deep grass or a soft surface, total distances can be reduced appreciably by lowering the flaps to 25° and rotating at lower airspeed.

A short field takeoff is accomplished without flaps by applying full power before brake release; lift off at 40-52 KIAS (depending on weight) and accelerate to and maintain 44-57 KIAS (depending on weight) past obstacle and climb out at 79 KIAS.

A short field takeoff with an obstacle clearance is accomplished by first lowering the flaps to 25°. Apply full power before brake release and accelerate to 40-52 KIAS (depending on weight) and rotate. Accelerate to and maintain 44-57 KIAS (depending on weight) until obstacle clearance is attained. After the obstacle has been cleared, accelerate to 79 KIAS and then slowly retract the flaps.

Takeoff from a soft field with an obstacle clearance requires the use of 25° flaps. Accelerate the airplane and lift the nose gear off as soon as possible and lift off at the lowest possible airspeed. Accelerate just above the ground to 52 KIAS to climb past obstacle clearance height. Continue climbing while accelerating to the best rate of climb speed, 79 KIAS and slowly retract the flaps.

For a soft field takeoff without an obstacle to clear, extend the flaps 25°, accelerate the airplane and lift the nose gear off as soon as possible. Lift off at the lowest possible airspeed. Accelerate just above the ground to the best rate of climb speed, 79 KIAS, and retract the flaps while climbing out.



**4.25 CLIMB**

The best rate of climb at gross weight will be obtained at 79 KIAS. The best angle of climb may be obtained at 63 KIAS. At lighter than gross weight these speeds are reduced somewhat. For climbing en route, a speed of 87 KIAS is recommended. This will produce better forward speed and increased visibility over the nose during the climb.

When reaching the desired altitude, the electric fuel pump may be turned off.

**4.27 CRUISE**

The cruising efficiency and speed is determined by many factors, including power setting, altitude, temperature, loading and equipment installed in the airplane.

The normal cruising power is 55% to 75% of the rated horsepower of the engine. Airspeeds which may be obtained at various altitudes and power settings can be determined from the performance graphs provided by Section 5.

Use of the mixture control in cruising flight significantly reduces fuel consumption while reducing lead deposits when alternate fuels are used. The mixture should be full rich when operating above 75% power, and leaned during cruising operation when 75% power or less is being used.

To lean the mixture for best power cruise performance place the mixture control full forward and set the throttle slightly below (approximately 35 RPM) the desired cruise power setting and lean the mixture to peak RPM. Adjust the throttle, if necessary, for final RPM setting.

For Best Economy cruise, a simplified leaning procedure which consistently allows accurate achievement of best engine efficiency has been developed. Best Economy Cruise performance is obtained with the throttle fully open. To obtain a desired cruise power setting, set the throttle and mixture control full forward, taking care not to exceed the engine speed limitation, then begin leaning the mixture. The RPM will increase slightly but will then begin to decrease. Continue leaning until the desired cruise engine RPM is reached. This will provide best fuel economy and maximum miles per gallon for a given power setting. See following CAUTION when using this procedure.

*CAUTION*

Prolonged operation at powers above 75% with a leaned mixture can result in engine damage. While establishing Best Economy Cruise Mixture, below 6,000 feet, care must be taken not to remain in the range above 75% power more than 15 seconds while leaning. Above 6,000 feet the engine is incapable of generating more than 75%.

Always remember that the electric fuel pump should be turned ON before switching tanks, and should be left on for a short period thereafter. In order to keep the airplane in best lateral trim during cruising flight, the fuel should be used alternately from each tank. It is recommended that one tank be used for one hour after takeoff, then the other tank be used for two hours; then return to the first tank, which will have approximately one and one half hours of fuel remaining if the tanks were full at takeoff. The second tank will contain approximately one half hour of fuel. Do not run tanks completely dry in flight. The electric fuel pump should be normally OFF, so that any malfunction of the engine driven fuel pump is immediately apparent. If signs of fuel starvation should occur at any time during flight, fuel exhaustion should be suspected, at which time the fuel selector should be immediately positioned to the other tank and the electric fuel pump switched to the ON position.

**4.29 DESCENT**

**NORMAL**

To achieve the performance on Figure 5-31, a power on descent must be used. The throttle should be set for 2500 RPM, mixture full rich and maintain an airspeed of 126 KIAS. In case carburetor ice is encountered apply full carburetor heat.

**POWER OFF**

If a prolonged power off descent is to be made, apply full carburetor heat prior to power reduction if icing conditions are suspected. Throttle should be retarded and mixture control leaned as required. Power response should be verified approximately every 30 seconds by partially opening and then closing the throttle (clearing the engine). When leveling off, enrichen mixture, set power as required and select carburetor heat off unless carburetor icing conditions are suspected.

**4.31 APPROACH AND LANDING (See charts in Section 5)**

Check to insure the fuel selector is on the proper (fullest) tank and that the seat backs are erect. The seat belts and shoulder harnesses should be fastened and the inertia reel checked.

Turn the electric fuel pump ON. The mixture should be set in the full RICH position.

The airplane should be trimmed to an initial-approach speed of about 70 KIAS with a final-approach speed of 63 KIAS with flaps extended to 40°. The flaps can be lowered at speeds up to 103 KIAS, if desired.

The mixture control should be kept in full RICH position to insure maximum acceleration if it should be necessary to open the throttle again. Carburetor heat should not be applied unless there is an indication of carburetor icing, since the use of carburetor heat causes a reduction in power which may be critical in case of a go-around. Full throttle operation with carburetor heat on can cause detonation.

The amount of flap used during landings and the speed of the aircraft at contact with the runway should be varied according to the landing surface and conditions of wind and airplane loading. It is generally good practice to contact the ground at the minimum possible safe speed consistent with existing conditions.

Normally, the best technique for short and slow landings is to use full flap and enough power to maintain the desired airspeed and approach flight path. Mixture should be full RICH, fuel on the fullest tank, and electric fuel pump ON. Reduce the speed during the flareout and contact the ground close to the stalling speed. After ground contact hold the nose wheel off as long as possible. As the airplane slows down, gently lower the nose and apply the brakes. Braking is most effective when flaps are raised and back pressure is applied to the control wheel, putting most of the aircraft weight on the main wheels. In high wind conditions, particularly in strong crosswinds, it may be desirable to approach the ground at higher than normal speeds with partial or no flaps.

**4.33 STOPPING ENGINE**

At the pilot's discretion, the flaps should be raised and the electric fuel pump turned OFF. The radios should be turned OFF, and the engine stopped by disengaging the mixture control lock and pulling the mixture control back to idle cut-off. The throttle should be left full aft to avoid engine vibration while stopping. Then the magneto, alternator and master switches must be turned OFF.

**NOTE**

When alternate fuels are used, the engine should be run up to 1200 RPM for one minute prior to shutdown to clean out any unburned fuel.

**NOTE**

The flaps must be placed in the UP position for the flap step to support weight. Passengers should be cautioned accordingly.

**4.35 PARKING**

If necessary, the airplane should be moved on the ground with the aid of the nose wheel tow bar provided with each airplane and secured behind the rear seats. The aileron and stabilator controls should be secured by looping the safety belt through the control wheel and pulling it snug. The flaps are locked when in the UP position and should be left retracted.

Tie downs can be secured to rings provided under each wing and to the tail skid. The rudder is held in position by its connections to the nose wheel steering and normally does not have to be secured.

#### **4.37 STALLS**

The stall characteristics are conventional. An approaching stall is indicated by a stall warning horn which is activated between five and ten KTS above stall speed. Mild airframe buffeting and gentle pitching may also precede the stall.

The gross weight stalling speed with power off and full flaps is 44 KIAS. With the flaps up this speed is increased. Loss of altitude during stalls varies from 100 to 275 feet, depending on configuration and power.

#### **NOTE**

The stall warning system is inoperative with the master switch OFF.

During preflight, the stall warning system should be checked by turning the master switch ON, lifting the detector and checking to determine if the horn is actuated. The master switch should be returned to the OFF position after the check is complete.

#### **4.39 TURBULENT AIR OPERATION**

In keeping with good operating practice used in all aircraft, it is recommended that when turbulent air is encountered or expected, the airspeed be reduced to maneuvering speed to reduce the structural loads caused by gusts and to allow for inadvertent speed build-ups which may occur as a result of the turbulence or of distractions caused by the conditions. (See Subsection 2.3.)

#### **4.41 WEIGHT AND BALANCE**

It is the responsibility of the owner and pilot to determine that the airplane remains within the allowable weight vs. center of gravity envelope while in flight.

For weight and balance data, refer to Section 6 (Weight and Balance).

**4.43 NOISE LEVEL**

The noise level of this aircraft is 72.9 dB(A).

No determination has been made by the Federal Aviation Administration that the noise levels of this airplane are or should be acceptable or unacceptable for operation at, into, or out of, any airport.

The above statement notwithstanding, the noise level stated above has been verified by and approved by the Federal Aviation Administration in noise level test flights conducted in accordance with FAR 36, Noise Standards - Aircraft Type and Airworthiness Certification. This aircraft model is in compliance with all FAR 36 noise standards applicable to this type.

**TABLE OF CONTENTS**  
**SECTION 5**  
**PERFORMANCE**

Paragraph No.	Page No.
5.1 General .....	5-1
5.3 Introduction - Performance and Flight Planning.....	5-1
5.5 Flight Planning Example.....	5-3
5.7 Performance Graphs.....	5-9
List of Figures .....	5-9

**THIS PAGE INTENTIONALLY LEFT BLANK**



**SECTION 5  
PERFORMANCE**

**5.1 GENERAL**

All of the required (FAA regulations) and complementary performance information applicable to this aircraft is provided by this section.

Performance information associated with those optional systems and equipment that require handbook supplements is provided by Section 9 (Supplements).

**5.3 INTRODUCTION - PERFORMANCE AND FLIGHT PLANNING**

The performance information presented in this section is based on measured Flight Test Data corrected to I.C.A.O. standard day conditions and analytically expanded for the various parameters of weight, altitude, temperature, etc.

The performance charts are unfactored and do not make any allowance for varying degrees of pilot proficiency or mechanical deterioration of the aircraft. This performance, however, can be duplicated by following the stated procedures in a properly maintained airplane.

Effects of conditions not considered on the charts must be evaluated by the pilot, such as the effect of soft or grass runway surface on takeoff and landing performance, or the effect of winds aloft on cruise and range performance. Endurance can be grossly affected by improper leaning procedures, and inflight fuel flow and quantity checks are recommended.

**REMEMBER!** To get chart performance, follow the chart procedures.

**SECTION 5**  
**PERFORMANCE**

**PA-28-161, WARRIOR III**

---

The information provided by paragraph 5.5 (Flight Planning Example) outlines a detailed flight plan using the performance charts in this section. Each chart includes its own example to show how it is used.

***WARNING***

Performance information derived by extrapolation beyond the limits shown on the charts should not be used for flight planning purposes.

## 5.5 FLIGHT PLANNING EXAMPLE

*NOTE:*

The information contained in this Section (5.5) is to be used for example purposes only.

## (a) Aircraft Loading

The first step in planning a flight is to calculate the airplane weight and center of gravity by utilizing the information provided by Section 6 (Weight and Balance) of this handbook.

The basic empty weight for the airplane as licensed at the factory has been entered in Figure 6-5. If any alterations to the airplane have been made affecting weight and balance, reference to the aircraft logbook and Weight and Balance Record (Figure 6-7) should be made to determine the current basic empty weight of the airplane.

Make use of the Weight and Balance Loading Form (Figure 6-11) and the C.G. Range and Weight graph (Figure 6-15) to determine the total weight of the airplane and the center of gravity position.

After proper utilization of the information provided, the following weights apply to the flight planning example.

The landing weight cannot be determined until the weight of the fuel to be used has been established [refer to item (g)(1)].

(1) Basic Empty Weight	1406 lbs.
(2) Occupants (4 x 170 lbs.)	680 lbs.
(3) Baggage and Cargo	50 lbs.
(4) Fuel (6 lb/gal x 30)	180 lbs.
(5) Takeoff Weight	2316 lbs.
(6) Landing Weight	
(a)(5) minus (g)(1), (2316 lbs.	
minus 188.4 lbs.	2127.6 lbs.

The takeoff weight is below the maximum of 2440 lbs., and the weight and balance calculations have determined that the C.G. position is within the approved limits.

(b) Takeoff and Landing

Now that the aircraft loading has been determined, all aspects of the takeoff and landing must be considered.

All of the existing conditions at the departure and destination airport must be acquired, evaluated and maintained throughout the flight.

Apply the departure airport conditions and takeoff weight to the appropriate Takeoff Performance graph (Figures 5-7 and 5-9 or 5-11 and 5-13) to determine the length of runway necessary for the takeoff and/or the barrier distance.

The landing distance calculations are performed in the same manner using the existing conditions at the destination airport and, when established, the landing weight.

The conditions and calculations for the example flight are listed below. The takeoff and landing distances required for the example flight have fallen well below the available runway lengths.

	Departure Airport	Destination Airport
(1) Pressure Altitude	1500 ft.	2500 ft.
(2) Temperature	27°C	24°C
(3) Wind Component	15 KTS (Headwind)	0 KTS
(4) Runway Length Available	4800 ft.	7600 ft.
(5) Runway Required	2100 ft.*	1105 ft.**

**NOTE**

The remainder of the performance charts used in this flight planning example assume a no wind condition. The effect of winds aloft must be considered by the pilot when computing climb, cruise and descent performance.

\*reference Figure 5-9

\*\*reference Figure 5-35

## (c) Climb

The next step in the flight plan is to determine the necessary climb segment components.

The desired cruise pressure altitude and corresponding cruise outside air temperature values are the first variables to be considered in determining the climb components from the Fuel, Time and Distance to Climb graph (Figure 5-19). After the fuel, time and distance for the cruise pressure altitude and outside air temperature values have been established, apply the existing conditions at the departure field to graph (Figure 5-19). Now, subtract the values obtained from the graph for the field of departure conditions from those for the cruise pressure altitude.

The remaining values are the true fuel, time and distance components for the climb segment of the flight plan corrected for field pressure altitude and temperature.

The following values were determined from the above instructions in the flight planning example.

- |   |             |
|---|-------------|
| (1) Cruise Pressure Altitude                          | 5000 ft.    |
| (2) Cruise OAT  | 16°C        |
| (3) Time to Climb (11.0 min. minus<br>3.0 min.)       | 8.0 min.*   |
| (4) Distance to Climb (16.0 miles minus<br>3.0 miles) | 13.0 miles* |
| (5) Fuel to Climb (3 gal. minus 1.0 gal.)             | 2.0 gal.*   |

## (d) Descent

The descent data will be determined prior to the cruise data to provide the descent distance for establishing the total cruise distance.

Utilizing the cruise pressure altitude and OAT, determine the basic fuel, time and distance for descent (Figure 5-31). These figures must be adjusted for the field pressure altitude and temperature at the destination airport. To find the necessary adjustment values, use the existing pressure altitude and temperature conditions at the destination airport as variables to find the fuel, time and distance

\*reference Figure 5-19

**SECTION 5**  
**PERFORMANCE**

**PA-28-161, WARRIOR III**

values from the graph (Figure 5-31). Now, subtract the values obtained from the field conditions from the values obtained from the cruise conditions to find the true fuel, time and distance values needed for the flight plan.

The values obtained by proper utilization of the graphs for the descent segment of the example are shown below.

- |  |            |
|--|------------|
| (1) Time to Descend<br>(8.8 min. minus 4.9 min.)         | 9.0 min.*  |
| (2) Distance to Descend<br>(19.6 miles minus 11.0 miles) | 8.6 miles* |
| (3) Fuel to Descend<br>(1.9 gal. minus 1.0 gal.)         | .9 gal.*   |

(e) Cruise

Using the total distance to be traveled during the flight, subtract the previously calculated distance to climb and distance to descend to establish the total cruise distance. Refer to the appropriate Avco Lycoming Operator's Manual when selecting the cruise power setting. The established pressure altitude and temperature values and the selected cruise power should now be utilized to determine the true airspeed from the Cruise Performance graph (Figure 5-21 or 5-23).

Calculate the cruise fuel consumption for the cruise power setting from the information provided by the Avco Lycoming Operator's Manual.

The cruise time is found by dividing the cruise distance by the cruise speed and the cruise fuel is found by multiplying the cruise fuel consumption by the cruise time.

The cruise calculations established for the cruise segment of the flight planning example are as follows:

- |  |             |
|--|-------------|
| (1) Total Distance   | 300 miles   |
| (2) Cruise Distance<br>(e)(1) minus (c)(4) minus (d)(2),<br>(300 minus 13 miles minus 8.6 miles) | 278.4 miles |

\*reference Figure 5-31

(3) Cruise Power Best Power Mixture	75% rated power (2665 RPM)
(4) Cruise Speed	114 KTS TAS*
(5) Cruise Fuel Consumption	11.4 GPH
(6) Cruise Time	
(e)(2) divided by (e)(4), (278.4 miles divided by 114 KTS)	2.44 hrs.
(7) Cruise Fuel	
(e)(5) multiplied by (e)(6), (11.4 GPH multiplied by 2.50 hrs.)	28.5 gal.

(f) Total Flight Time

The total flight time is determined by adding the time to climb, the time to descend and the cruise time. Remember! The time values taken from the climb and descent graphs are in minutes and must be converted to hours before adding them to the cruise time.

The following flight time is required for our flight planning example.

(1) Total Flight Time	
(c)(3) plus (d)(1) plus (e)(6), (.13 hrs. plus .07 hrs. plus 2.44 hrs.)	2.64 hrs.

(g) Total Fuel Required

Determine the total fuel required by adding the fuel to climb, the fuel to descend and the cruise fuel. When the total fuel (in gallons) is determined, multiply this value by 6 lb/gal. to determine the total fuel weight used for the flight.

The total fuel calculations for the example flight plan are shown below.

(1) Total Fuel Required	
(c)(5) plus (d)(3) plus (e)(7), (2.0 gal. plus .9 gal. plus 28.5 gal.)	31.4 gal.
(31.4 gal. multiplied by 6 lb/gal.)	188.4 lbs.

\*reference Figure 5-23b

**THIS PAGE INTENTIONALLY LEFT BLANK**



## 5.7 PERFORMANCE GRAPHS

## LIST OF FIGURES

Figure No.		Page No.
5-1	Temperature Conversion .....	5-11
5-3	Airspeed System Calibration.....	5-12
5-5	Stall Speed.....	5-13
5-7	0° Flaps Takeoff Ground Roll .....	5-14
5-9	0° Flaps Takeoff Performance.....	5-15
5-11	25° Flaps Takeoff Ground Roll .....	5-16
5-13	25° Flaps Takeoff Performance .....	5-17
5-15	Engine Performance .....	5-18
5-17	Climb Performance .....	5-19
5-19	Fuel, Time and Distance to Climb.....	5-20
5-21	Cruise Performance- Speed Power.....	5-20b
5-23	Engine & Cruise Performance- 55% Power.....	5-21
5-23a	Engine & Cruise Performance- 65% Power.....	5-21
5-23b	Engine & Cruise Performance- 75% Best Power.....	5-23
5-25	Range.....	5-24
5-29	Endurance.....	5-25
5-31	Fuel, Time and Distance to Descend.....	5-26
5-33	Glide Performance.....	5-27
5-35	Landing Distance.....	5-28
5-37	Landing Ground Roll Distance .....	5-29

**THIS PAGE INTENTIONALLY LEFT BLANK**

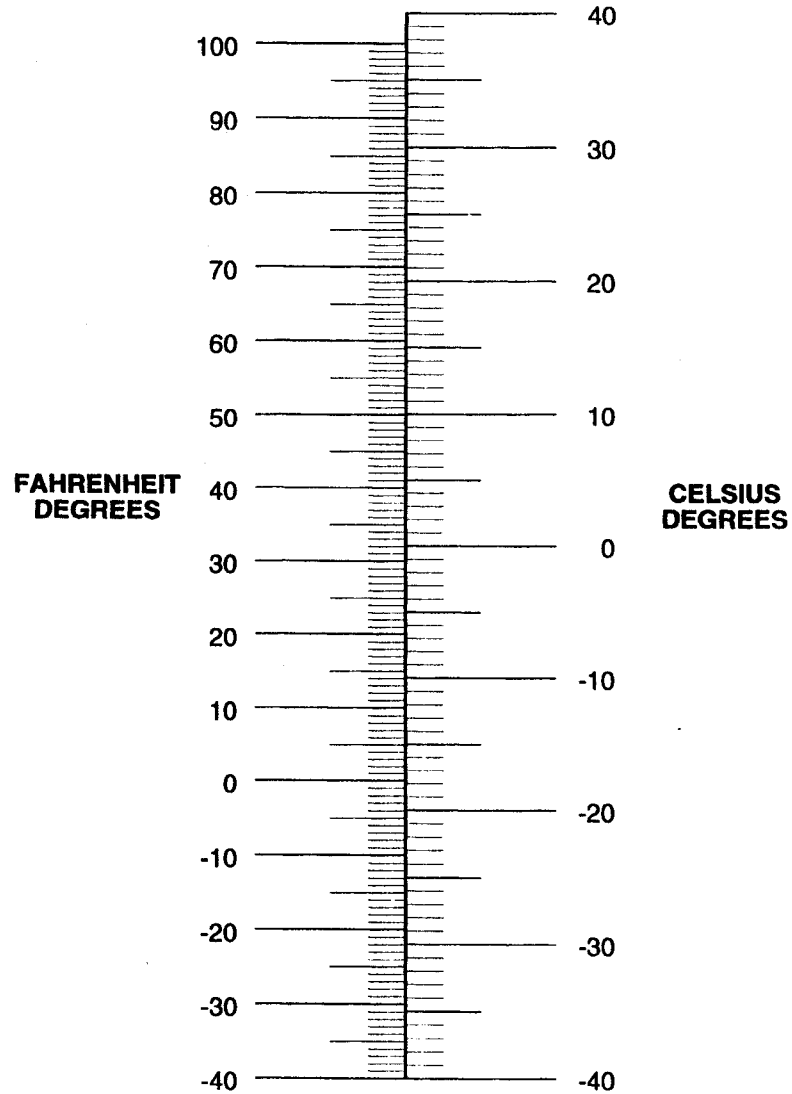

TEMPERATURE CONVERSION

Figure 5-1

# PA-28-161

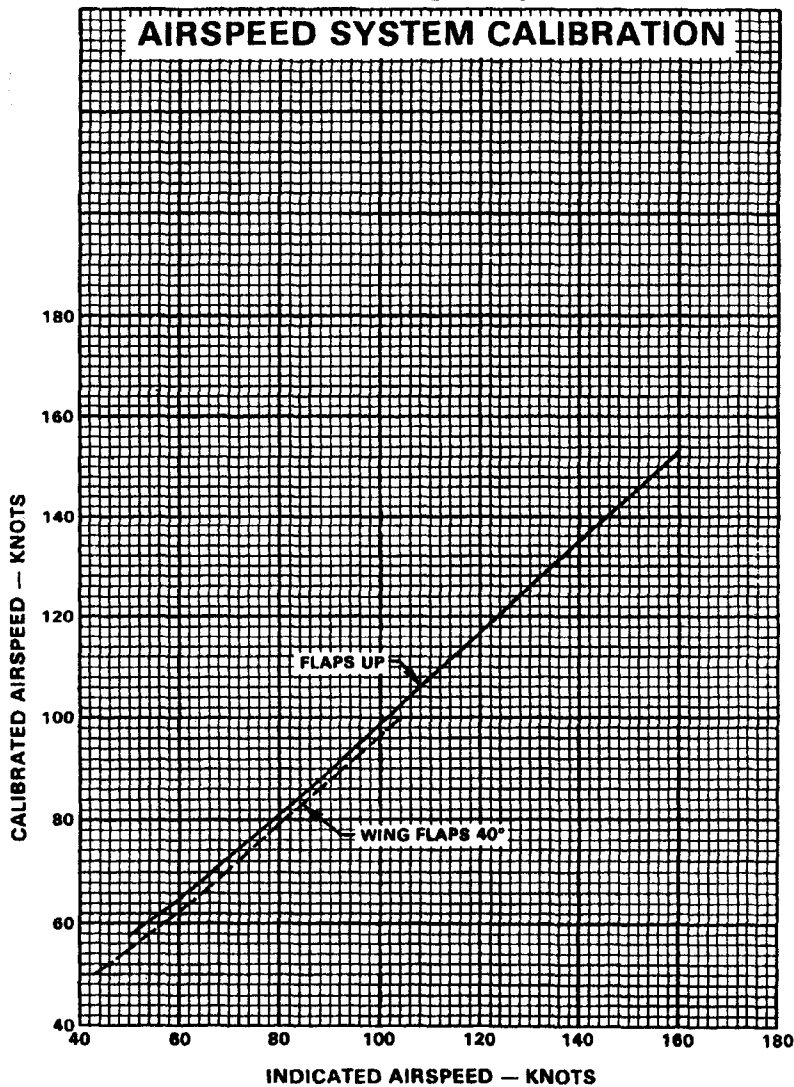

AIRSPEED SYSTEM CALIBRATION

Figure 5-3

PA-28-161

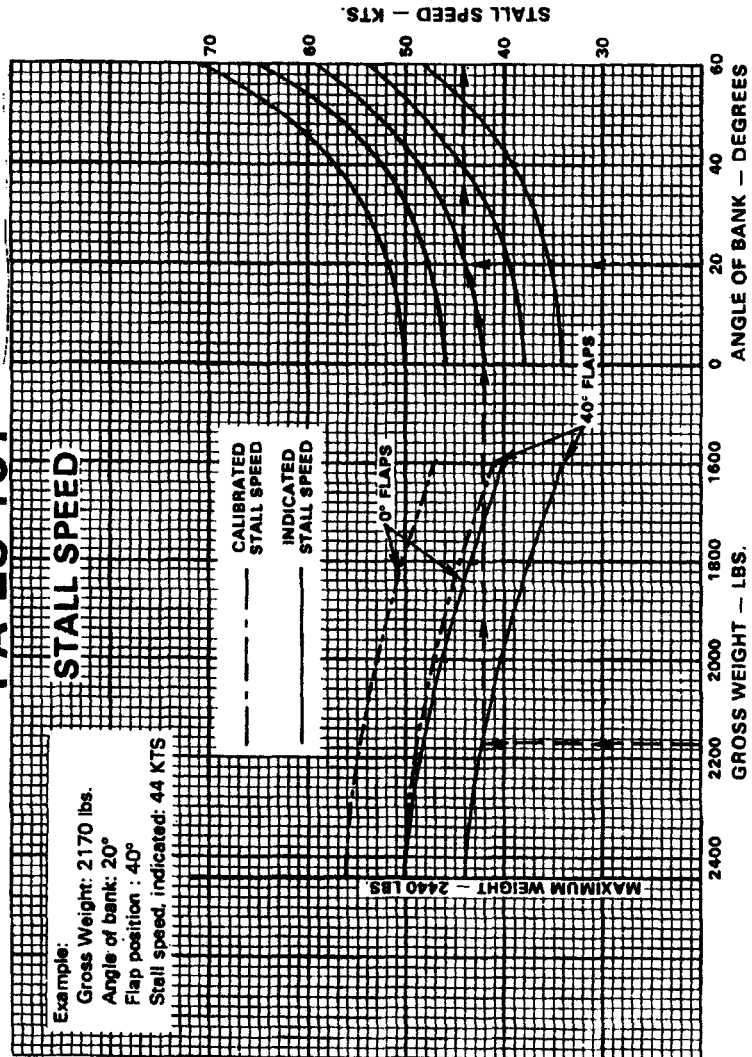

STALL SPEED

Figure 5-5

# PA-28-161

## 0° FLAPS TAKEOFF GROUND ROLL

ASSOCIATED CONDITIONS:  
PAVED, LEVEL, DRY RUNWAY  
FULL POWER BEFORE BRAKE RELEASE  
FLAPS 0°

Example:

Departure airport pressure altitude: 1500 ft.  
Departure airport temperature: 27°C.  
Weight: 2316 lbs.  
Wind: 15 KTS headwind  
Ground roll: 1150 ft.  
Lift-off speed: 50 KIAS

0° FLAPS TAKEOFF GROUND ROLL

Figure 5-7

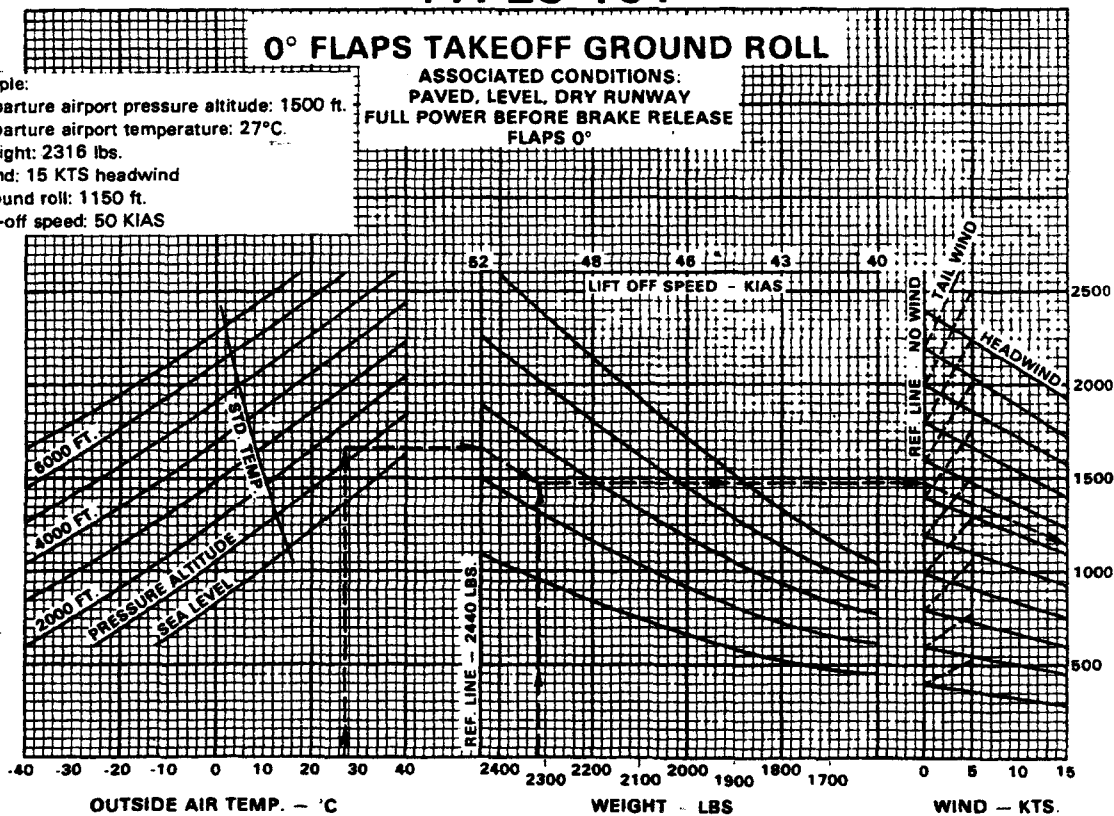

# PA-28-161

## 0° FLAPS TAKEOFF PERFORMANCE

ASSOCIATED CONDITIONS:  
PAVED, LEVEL, DRY RUNWAY  
FULL POWER BEFORE BRAKE  
RELEASE  
FLAPS 0°

Example:

Departure airport pressure altitude: 1500 ft.  
Departure airport temperature: 27°C  
Weight: 2316 lbs.  
Wind: 15 KTS headwind  
Distance over 50 ft. barrier: 2100 ft.  
Lift-off speed: 50 KIAS  
Barrier speed: 55 KIAS

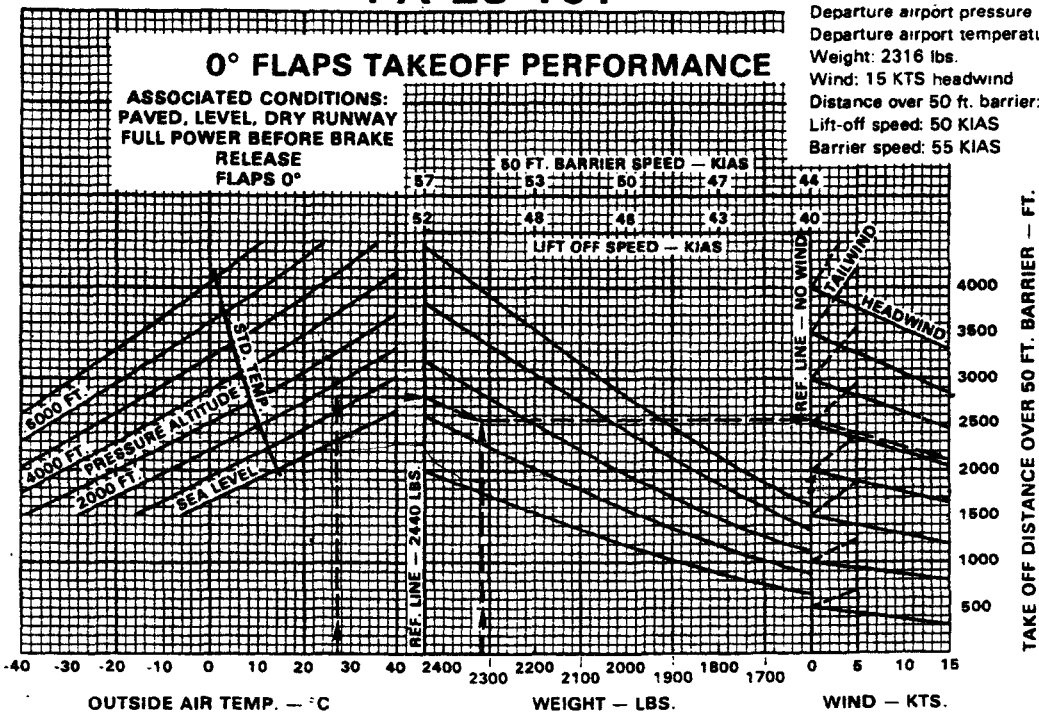

0° FLAPS TAKEOFF PERFORMANCE

Figure 5-9

# PA-28-161

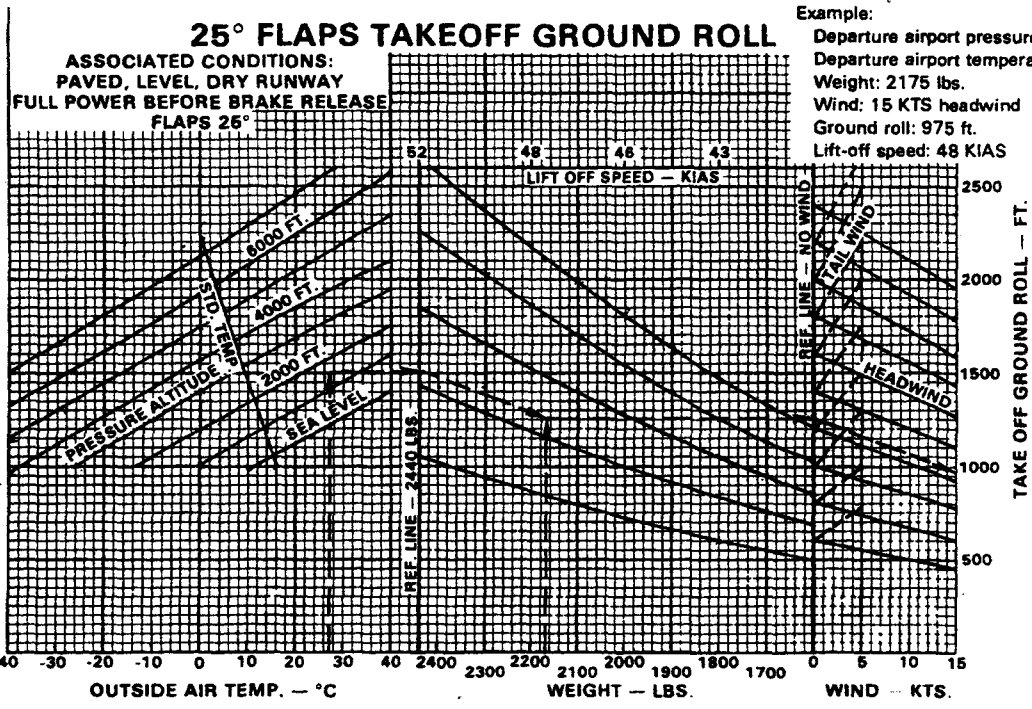

25° FLAPS TAKEOFF GROUND ROLL

Figure 5-11



# PA-28-161

## 25° FLAPS TAKEOFF PERFORMANCE

ASSOCIATED CONDITIONS:  
PAVED, LEVEL, DRY RUNWAY  
FULL POWER BEFORE BRAKE RELEASE  
FLAPS 25°

Example:

Departure airport pressure altitude: 1500 ft.  
Departure airport temperature: 27°C  
Weight: 2175 lbs.  
Wind: 15 KTS headwind  
Distance over 50 ft. barrier: 1500 ft.  
Lift-off speed: 48 KIAS  
Barrier speed: 53 KIAS

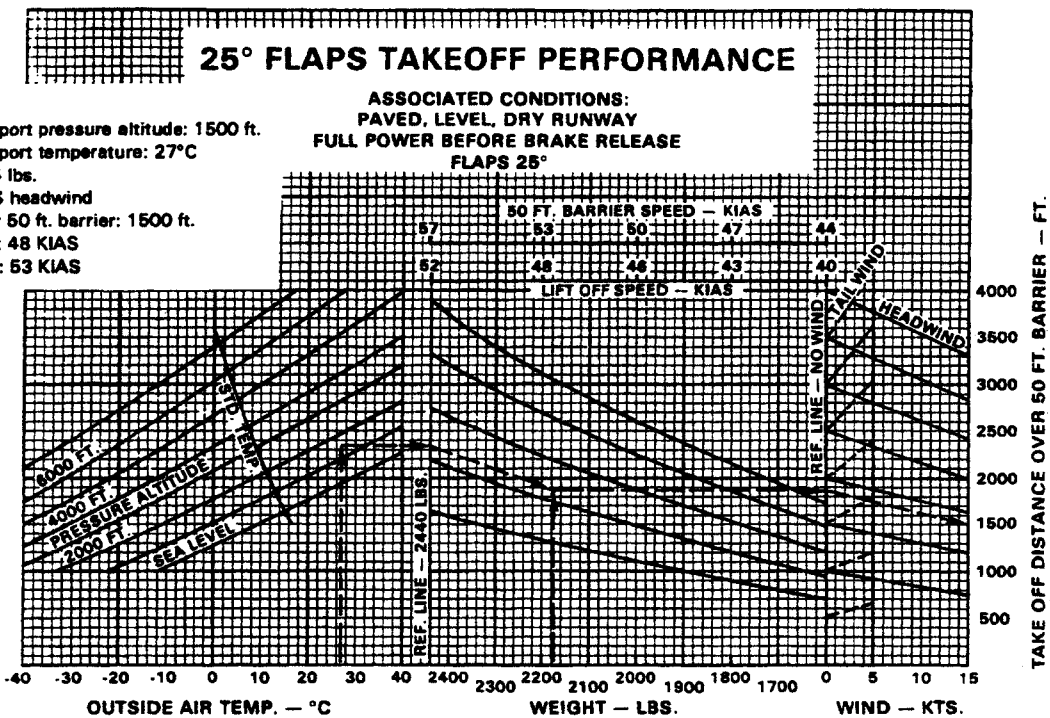

25° FLAPS TAKEOFF PERFORMANCE

Figure 5-13

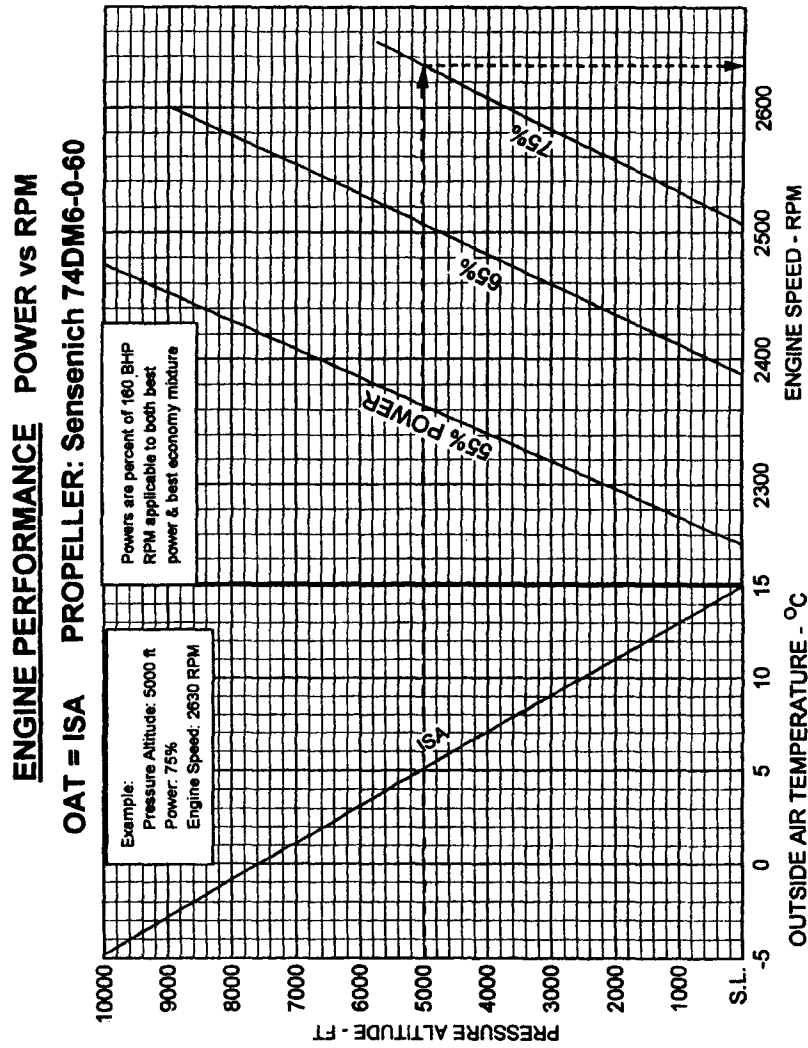

ENGINE PERFORMANCE

Figure 5-15

**MAXIMUM RATE OF CLIMB****ASSOCIATED CONDITIONS:**

GROSS WEIGHT: 2440 lb.

POWER: FULL THROTTLE

MIXTURE: FULL RICH

FLAPS: UP

AIRSPEED: 79 KIAS

**EXAMPLE**

PRESSURE ALTITUDE: 5000FT

OAT: 16° C (ISA + 11° C)

MAX RATE OF CLIMB: 374 FPM

PRESSURE ALTITUDE FEET	OUTSIDE AIR TEMPERATURE				
	ISA - 15° C	ISA	ISA + 10° C	ISA + 20° C	ISA + 30° C
S.L.	677	644	624	604	585
1000	628	595	574	554	534
2000	578	545	524	504	485
3000	528	495	475	455	436
4000	478	446	425	405	386
5000	429	396	376	356	337
6000	379	346	326	306	287
7000	330	298	277	257	238
8000	280	248	227	207	188
9000	231	198	177	157	138
10000	181	149	128	108	89
11000	132	99	79	59	40
12000	83	49	29	9	-10
13000	33	0	-21	-41	-60

## CLIMB PERFORMANCE

Figure 5-17

## TIME, FUEL, &amp; DISTANCE TO CLIMB

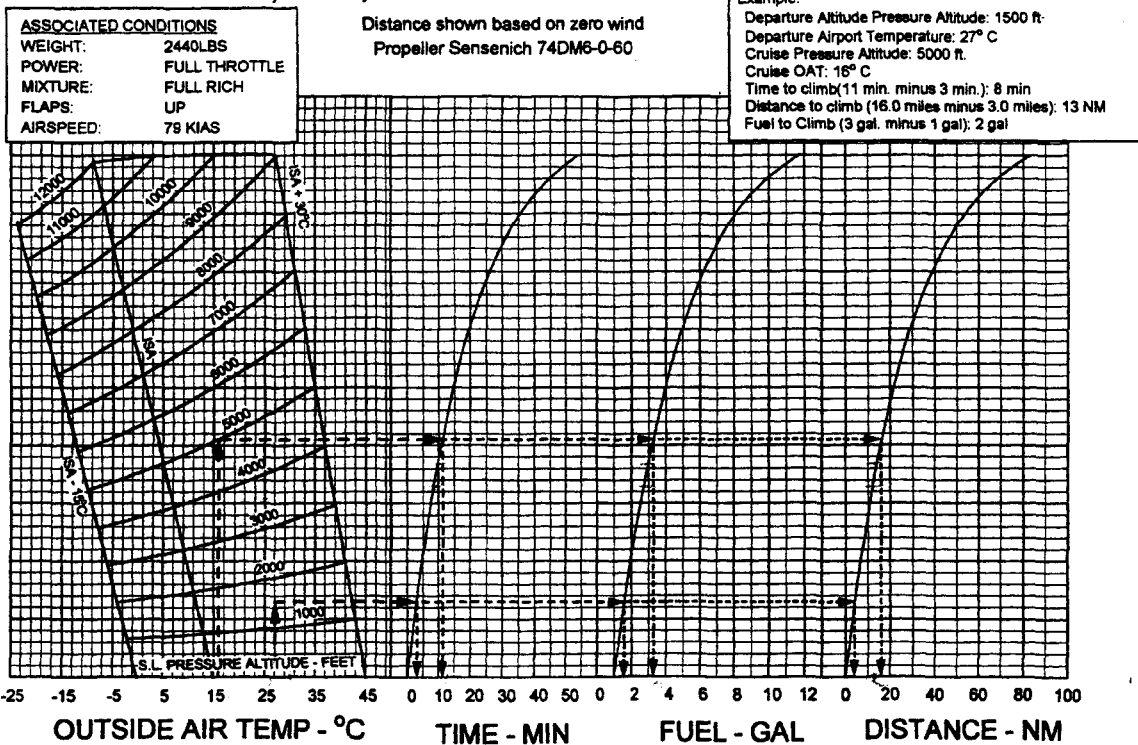

**THIS PAGE INTENTIONALLY LEFT BLANK**

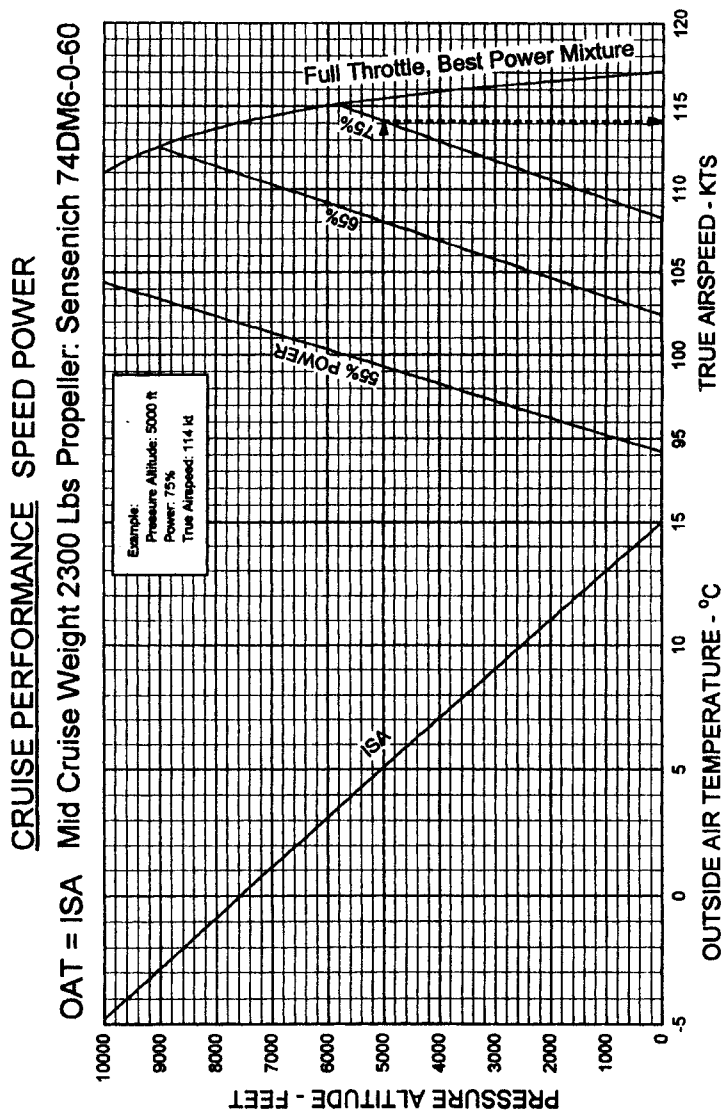

Figure 5-21

**Engine & Cruise Performance for Non-ISA OAT  
RPM for Constant 55% Power  
Fuel Flow: Best Economy Mixture 7.9 GPH**

Pressure Altitude	Indicated Outside Air Temperature			Engine Speed RPM	True Air Speed Knots
	Feet	°C	°C		
Sea Level	ISA-15	0	32	2210	92
	ISA	15	59	2250	
	ISA +10	25	77	2280	
	ISA +20	35	95	2300	
	ISA +30	45	113	2330	
2000	ISA -15	-4	25	2260	94
	ISA	11	52	2300	
	ISA +10	21	70	2320	
	ISA +20	31	88	2350	
	ISA +30	41	106	2370	
4000	ISA -15	-8	18	2300	96
	ISA	7	45	2340	
	ISA +10	17	63	2370	
	ISA +20	27	81	2400	
	ISA +30	37	99	2420	
6000	ISA -15	-12	10	2350	98
	ISA	3	37	2390	
	ISA +10	13	55	2410	
	ISA +20	23	73	2440	
	ISA +30	33	91	2460	
8000	ISA -15	-16	4	2390	100
	ISA	-1	31	2430	
	ISA +10	9	49	2460	
	ISA +17.5	16.5	62	2475	
9000	ISA -15	-18	0	2410	101
	ISA	-3	27	2450	
	ISA +8.5	5.5	42	2480	
10000	ISA -15	-20	-3	2430	102
	ISA	-5	24	2480	

Example:

Cruise Altitude: 5000 ft

Cruise Temperature: 16° C (ISA + 11° C)

Engine Speed: 2390 RPM (By Interpolation)

**ENGINE & CRUISE PERFORMANCE - 55% POWER**

Figure 5-23

**SECTION 5  
PERFORMANCE**

**PA-28-161, WARRIOR III**

**Engine & Cruise Performance for Non-ISA OAT  
RPM for Constant 65% Power  
Fuel Flow: Best Economy Mixture 9.2 GPH**

Pressure Altitude	Indicated Outside Air Temperature			Engine Speed	True Air Speed
	Feet	°C	°C	°F	RPM
Sea Level	ISA -15	0	32	2340	100
	ISA	15	59	2390	
	ISA +10	25	77	2420	
	ISA +20	35	95	2440	
	ISA +30	45	113	2470	
2000	ISA -15	-4	25	2390	103
	ISA	11	52	2440	
	ISA +10	21	70	2460	
	ISA +20	31	88	2490	
	ISA +30	41	106	2520	
4000	ISA -15	-8	18	2440	105
	ISA	7	45	2480	
	ISA +10	17	63	2510	
	ISA +20	27	81	2540	
	ISA +30	37	99	2560	
6000	ISA -15	-12	10	2490	107
	ISA	3	37	2530	
	ISA +10	13	55	2560	
	ISA +20	23	73	2580	
	ISA +30	33	91	2600	
8000	ISA -15	-16	4	2530	109
	ISA	-1	31	2580	
	ISA +10	9	49	2610	
	ISA +17.5	16.5	62	2630	
9000	ISA -15	-18	0	2560	110
	ISA	-3	27	2600	
	ISA +8.5	5.5	42	2630	
10000	ISA -15	-20	-3	2580	112

Example:

Cruise Altitude: 5000 ft

Cruise Temperature: 16° C (ISA + 11° C)

Engine Speed: 2540 RPM (By Interpolation)

**ENGINE & CRUISE PERFORMANCE - 65% POWER**

Figure 5-23a



**Engine & Cruise Performance for Non-ISA OAT  
RPM for Constant 75% Power  
Fuel Flow: Best Power Mixture 11.4 GPH**

Pressure Altitude	Indicated Outside Air Temperature			Engine Speed	True Air Speed
	Feet	°C	°C	°F	RPM
Sea Level	ISA-15	0	32	2460	106
	ISA	15	59	2510	
	ISA +10	25	77	2540	
	ISA +20	35	95	2560	
	ISA +30	45	113	2590	
2000	ISA -15	-4	25	2510	108
	ISA	11	52	2560	
	ISA +10	21	70	2590	
	ISA +20	31	88	2620	
	ISA +30	41	106	2640	
3000	ISA -15	-6	21	2540	109
	ISA	9	48	2580	
	ISA +10	19	66	2610	
	ISA +20	29	84	2640	
	ISA +30	39	102	2670	
4000	ISA -15	-8	18	2560	110
	ISA	7	45	2610	
	ISA +10	17	63	2640	
	ISA +20	27	81	2670	
	ISA +30	37	99	2690	
5000	ISA -15	-10	14	2590	112
	ISA	5	41	2630	
	ISA +10	15	59	2660	
	ISA +20	25	77	2690	
6000	ISA -15	-12	10	2610	113
	ISA	3	37	2660	
	ISA +10	13	55	2690	
7000	ISA -15	-14	6.8	2640	114
	ISA	1	34	2690	

Example:

Cruise Altitude: 5000 ft

Cruise Temperature: 16° C (ISA + 11° C)

Engine Speed: 2665 RPM (By Interpolation)

**ENGINE & CRUISE PERFORMANCE - 75% BEST POWER**

Figure 5-23b

**RANGE**

ASSOCIATED CONDITIONS:  
48 GAL USABLE FUEL      2440 LBS GROSS WT.  
PROPELLER SENSENICH 74DM6-0-80

POWER	MIXTURE
55%	BEST ECONOMY
65%	BEST ECONOMY
75%	BEST POWER

Note: See Section 4.27 for mixture setting procedure

Example:  
Cruise pressure altitude: 5000 ft.  
Cruise power: 75% Best power mixture  
Range w/ 45 min. reserve @ 55% power: 414 NM  
Range w/o reserve: 474 NM

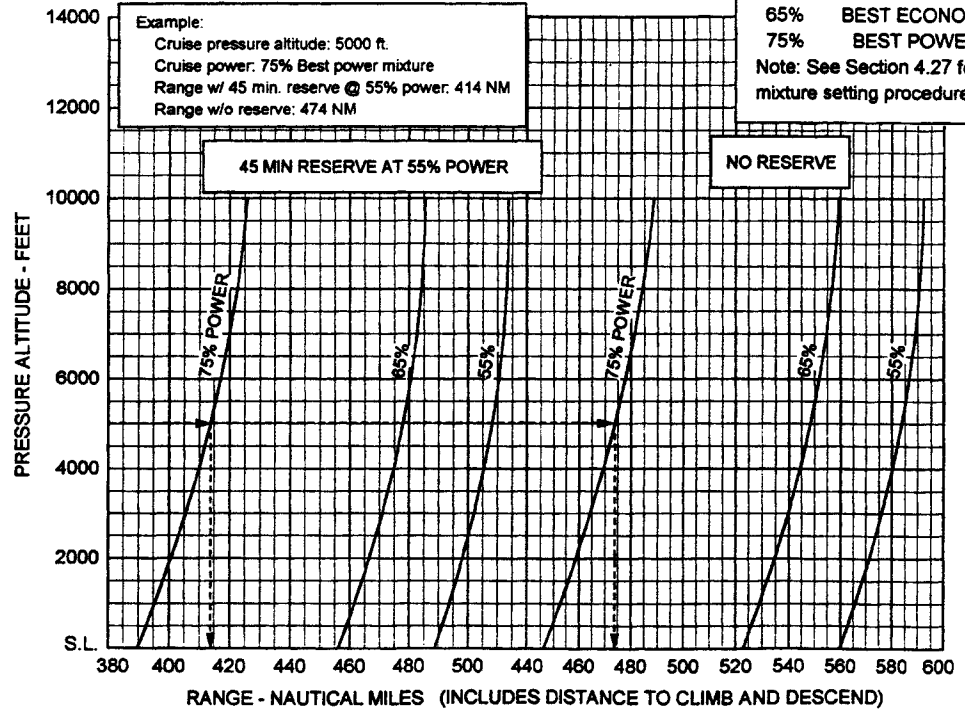

RANGE  
Figure 5-25

**ENDURANCE****ASSOCIATED CONDITIONS**

48 GAL USABLE FUEL 2440 LBS GROSS WT.  
PROPELLER SENSENICH 74DM6-0-60

POWER	MIXTURE
55%	BEST ECONOMY
65%	BEST ECONOMY
75%	BEST POWER

Note: See Section 4.27 for  
mixture setting procedure

**Example:**

Cruise pressure altitude: 5000 ft.  
Cruise power: 75% best power mixture  
Endurance w/ 45 min. reserve @ 55%  
power: 3.65 hrs.  
Endurance w/o reserve: 4.17

**ENDURANCE**

Figure 5-29

ISSUED: JULY 12, 1995

REPORT: VB-1610

5-25

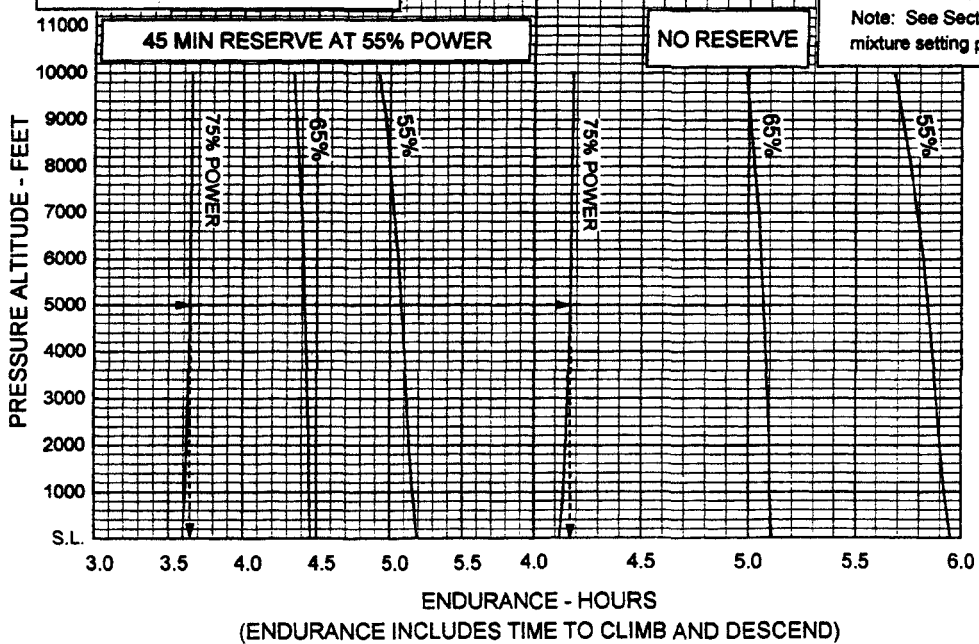
**TIME, FUEL, AND DISTANCE TO DESCEND**Distance show based on zero wind  
Propeller Sensenich 74DM6-0-60**ASSOCIATED CONDITIONS**POWER: 2500 RPM  
AIRSPEED: 126 KIAS

PRESSURE ALTITUDE FEET	ISA - 15° C			ISA ° C			ISA + 10° C			ISA + 20° C			ISA + 30° C		
	TIME MIN	FUEL GAL	DIST NM	TIME MIN	FUEL GAL	DIST NM	TIME MIN	FUEL GAL	DIST NM	TIME MIN	FUEL GAL	DIST NM	TIME MIN	FUEL GAL	DIST NM
0	0	0	0	0	0	0	0	0	0	0	0	0	0	0	0
1000	8	2	16	5	1	10	3	1	6	2	1	4	1	1	3
2000	21	4	43	8	2	17	5	1	10	3	1	8	3	1	6
3000	26	4	53	10	2	22	6	1	14	5	1	11	4	1	9
4000	29	5	59	12	2	26	8	2	17	6	1	13	5	1	11
5000	31	5	64	14	2	29	9	2	20	7	1	16	6	1	13
6000	33	5	67	15	3	32	10	2	22	8	2	18	7	1	15
7000	34	6	70	16	3	34	11	2	24	9	2	20	7	1	17
8000	35	6	73	17	3	36	12	2	26	9	2	21	8	2	18
9000	36	6	76	18	3	38	13	2	28	10	2	23	9	2	20
10000	37	6	78	19	3	40	13	2	30	11	2	25	9	2	21
11000	38	6	80	19	3	42	14	2	31	11	2	26	10	2	23
12000	39	6	81	20	3	43	15	2	33	12	2	28	10	2	24

**Example:**

Cruise Pressure Altitude: 5000 ft  
 Cruise Temperature: 16° C (ISA + 11° C)  
 Time To Descend: 8.8 min (By Interpolation)  
 Fuel To Descend: 1.9 gal (By Interpolation)  
 Distance To Descend: 19.6 miles (By Interpolation)  
 Destination Airport Pressure Altitude: 2500 ft  
 Destination Airport Temperature: 24° C (ISA + 14° C)

Time To Descend: 4.9 min (By Interpolation)  
 Fuel To Descend: 1.0 gal  
 Distance To Descend: 11 miles

Actual Time To Descend From Cruise To Destination Airport (8.8 - 4.9): 3.9 min  
 Actual Fuel To Descend From Cruise To Destination Airport (1.9 - 1): 0.9 gal  
 Actual Distance To Descend From Cruise To Destination Airport (19.6 - 11): 8.6 NM

FUEL, TIME AND DISTANCE TO DESCEND

Figure 5-31

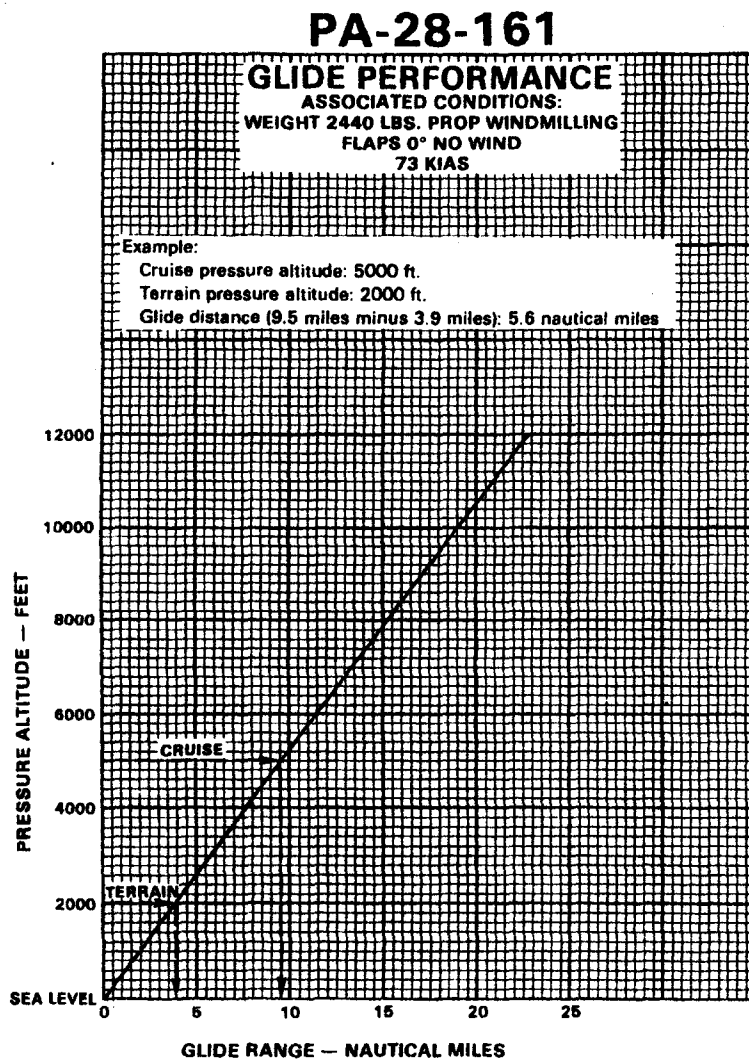

## GLIDE PERFORMANCE

Figure 5-33

# PA-28-161

## LANDING DISTANCE

ASSOCIATED CONDITIONS:  
POWER OFF, FLAPS - 40°

PAVED LEVEL DRY RUNWAY, MAXIMUM BRAKING

Example:

Destination airport altitude: 2500 ft.  
Destination airport temperature: 24°C  
Destination airport wind: 0 KTS  
Landing Weight: 2179 lbs.  
Distance over 50 ft. barrier: 1135 ft.

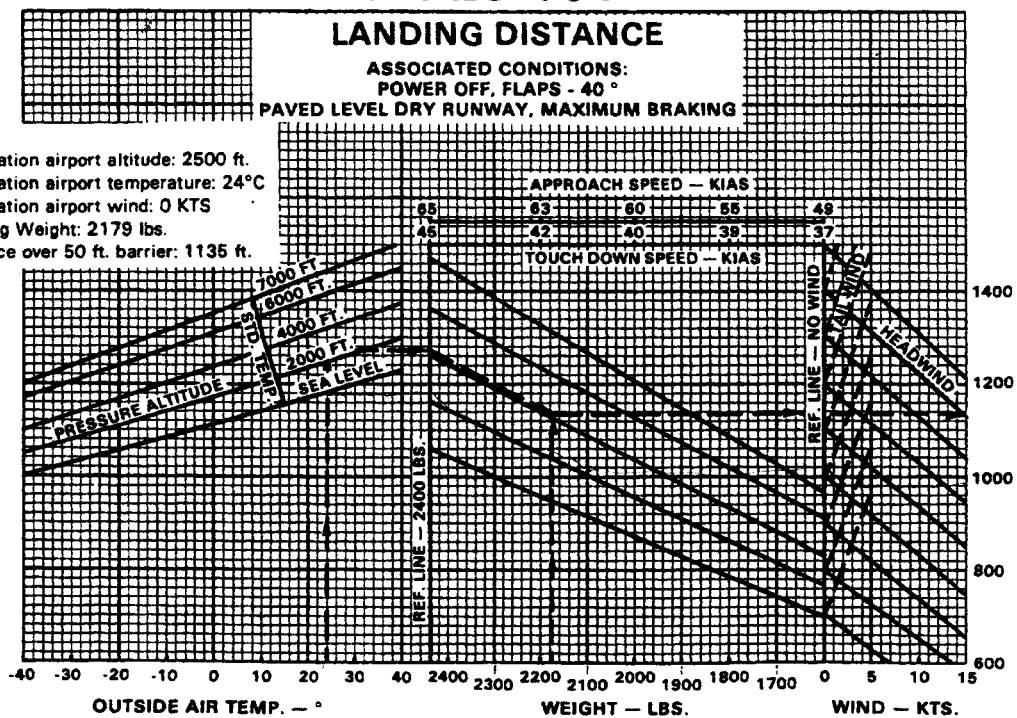

LANDING DISTANCE

Figure 5-35

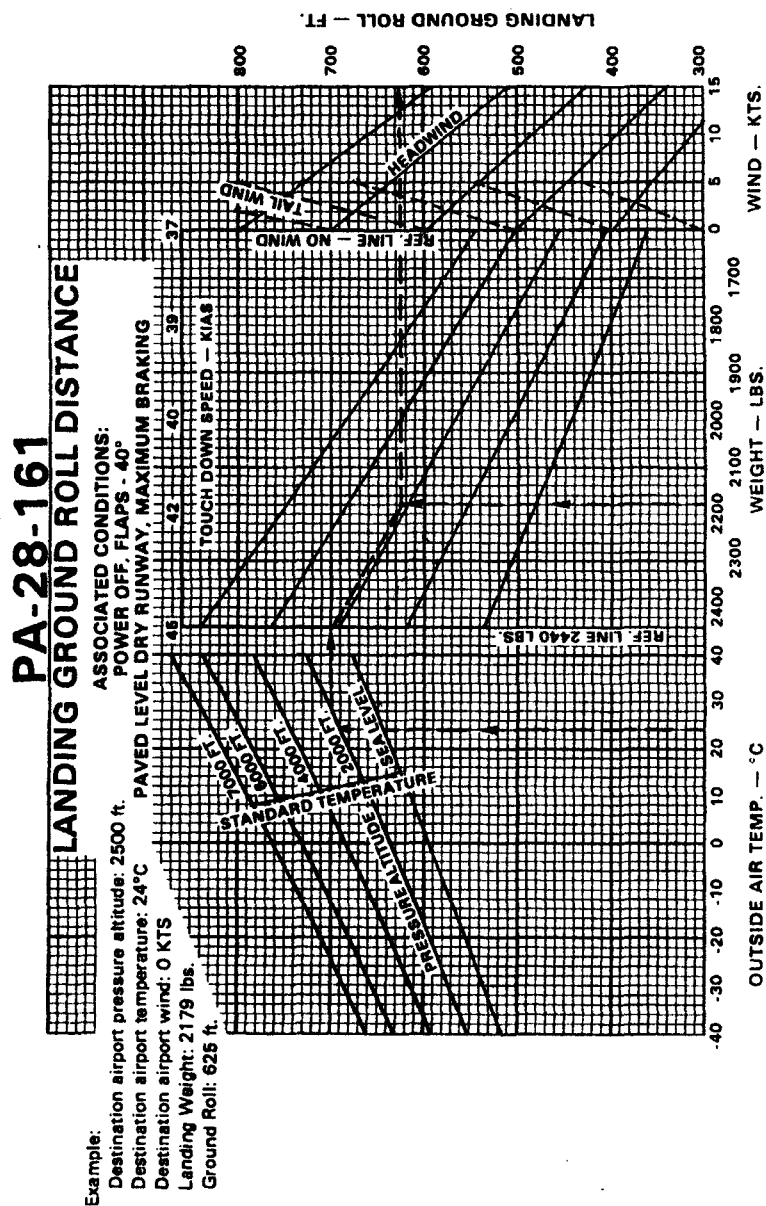

LANDING GROUND ROLL DISTANCE

Figure 5-37

**THIS PAGE INTENTIONALLY LEFT BLANK**



**TABLE OF CONTENTS**  
**SECTION 6**  
**WEIGHT AND BALANCE**

Paragraph No.		Page No.
6.1	General .....	6-1
6.3	Airplane Weighing Procedure .....	6-2
6.5	Weight and Balance Data and Record .....	6-6
6.7	Weight and Balance Determination for Flight .....	6-11
	Equipment List (Form 240-0199) .....	Supplied with aircraft paperwork

**THIS PAGE INTENTIONALLY LEFT BLANK**

**SECTION 6  
WEIGHT AND BALANCE**

**6.1 GENERAL**

In order to achieve the performance and flying characteristics which are designed into the airplane, it must be flown with the weight and center of gravity (C.G.) position within the approved operating range (envelope). Although the airplane offers a flexibility of loading, it cannot be flown with the maximum number of adult passengers, full fuel tanks and maximum baggage. With this loading flexibility comes responsibility. The pilot must insure that the airplane is loaded within the loading envelope before takeoff.

Misloading carries consequences for any aircraft. An overloaded airplane will not take off, climb or cruise as well as a properly loaded one. The heavier the airplane is loaded, the less climb performance it will have.

Center of gravity is a determining factor in flight characteristics. If the C.G. is too far forward in any airplane, it may be difficult to rotate for takeoff or landing. If the C.G. is too far aft, the airplane may rotate prematurely on takeoff or tend to pitch up during climb. Longitudinal stability will be reduced. This can lead to inadvertent stalls and even spins; and spin recovery becomes more difficult as the center of gravity moves aft of the approved limit.

A properly loaded airplane, however, will perform as intended. Before the airplane is licensed, it is weighed, and a basic empty weight and C.G. location is computed (basic empty weight consists of the standard empty weight of the airplane plus the optional equipment). Using the basic empty weight and C.G. location, the pilot can easily determine the weight and C.G. position for the loaded airplane by computing the total weight and moment and then determining whether they are within the approved envelope.

The basic empty weight and C.G. location are recorded in the Weight and Balance Data Form (Figure 6-5) and the Weight and Balance Record (Figure 6-7). The current values should always be used. Whenever new equipment is added or any modification work is done, the mechanic responsible for the work is required to compute a new basic empty weight and C.G. position and to write these in the Aircraft Log Book and the Weight and Balance Record. The owner should make sure that it is done.

A weight and balance calculation is necessary in determining how much fuel or baggage can be loaded so as to keep within allowable limits. Check calculations prior to adding fuel to insure against improper loading.

The following pages are forms used in weighing an airplane in production and in computing basic empty weight, C.G. position, and useful load. Note that the useful load includes usable fuel, baggage, cargo and passengers. Following this is the method for computing takeoff weight and C.G.

### **6.3 AIRPLANE WEIGHING PROCEDURE**

At the time of licensing, Piper provides each airplane with the basic empty weight and center of gravity location. This data is supplied by Figure 6-5.

The removal or addition of equipment or airplane modifications can affect the basic empty weight and center of gravity. The following is a weighing procedure to determine this basic empty weight and center of gravity location:

(a) Preparation

- (1) Be certain that all items checked in the airplane equipment list are installed in the proper location in the airplane.
- (2) Remove excessive dirt, grease, moisture, and foreign items, such as rags and tools, from the airplane before weighing.

- (3) Defuel airplane. Then open all fuel drains until all remaining fuel is drained. Operate engine on each tank until all undrainable fuel is used and engine stops. Then add the unusable fuel (2.0 gallons total, 1.0 gallon each wing).

*CAUTION*

Whenever the fuel system is completely drained and fuel is replenished, it will be necessary to run the engine for a minimum of three minutes at 1000 RPM on each tank to insure no air exists in the fuel supply lines.

- (4) Fill with oil to full capacity.
- (5) Place pilot and copilot seats in fourth (4th) notch, aft of forward position. Put flaps in fully retracted position and all control surfaces in the neutral position. Tow bar should be in the proper location and all entrance and baggage doors should be closed.
- (6) Weigh the airplane inside a closed building to prevent errors in the scale readings due to wind.

(b) Leveling

- (1) With airplane on scales, block main gear oleo pistons in the fully extended position.
- (2) Level airplane (refer to Figure 6-3) by deflating the nose wheel tire to center bubble on level.

**SECTION 6**  
**WEIGHT AND BALANCE**

**PA-28-161, WARRIOR III**

(c) Weighing - Airplane Basic Empty Weight

With the airplane level and brakes released, record the weight shown on each scale. Deduct the tare, if any, from each reading.

Scale Position and Symbol	Scale Reading	Tare	Net Weight
Nose Wheel (N)			
Right Main Wheel (R)			
Left Main Wheel (L)			
Basic Empty Weight, (as Weighed) (T)			

**WEIGHING FORM**

Figure 6-1

## (d) Basic Empty Weight Center of Gravity

- (1) The following geometry applies to the PA-28-161 airplane when it is level. Refer to Leveling paragraph 6.3 (b).

**LEVELING DIAGRAM**

Figure 6-3

- (2) The basic empty weight center of gravity (as weighed including optional equipment, full oil and unusable fuel) can be determined by the following formula:

$$\text{C.G. Arm} = \frac{N(A) + (R + L)(B)}{T} \text{ inches}$$

Where:  $T = N + R + L$

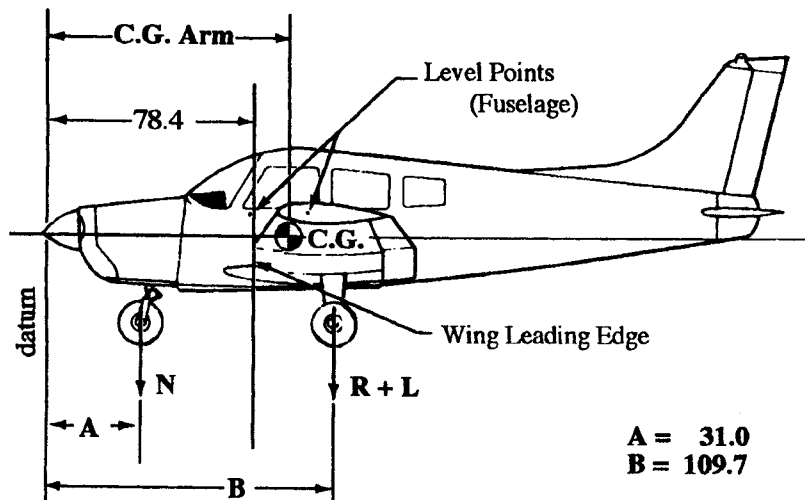
**6.5 WEIGHT AND BALANCE DATA AND RECORD**

The Basic Empty Weight, Center of Gravity Location and Useful Load listed in Figure 6-5 are for the airplane as licensed at the factory. These figures apply only to the specific airplane serial number and registration number shown.

The basic empty weight of the airplane as licensed at the factory has been entered in the Weight and Balance Record (Figure 6-7). This form is provided to present the current status of the airplane basic empty weight and a complete history of previous modifications. Any change to the permanently installed equipment or modification which affects weight or moment must be entered in the Weight and Balance Record and Equipment List.



## MODEL PA-28-161 WARRIOR III

Airplane Serial Number    **2842158**  
 Registration Number        **N53453**  
 Date                            **05/09/02**

## AIRPLANE BASIC EMPTY WEIGHT

Item	Weight (Lbs)	C.G. Arm	
		x (Inches Aft of Datum)	= Moment (In-Lbs)
Actual	<b>1543.6</b>	<b>86.3749</b>	<b>133328.3</b>
Standard Empty Weight* <del>Computed</del>			
Optional Equipment	<b>31.6</b>	<b>105.3924</b>	<b>3330.4</b>
Basic Empty Weight	<b>1575.2</b>	<b>86.7564</b>	<b>136658.7</b>

\*The standard empty weight includes full oil capacity and 2.0 gallons of unusable fuel.

## AIRPLANE USEFUL LOAD ---- NORMAL CATEGORY OPERATION

(Ramp Weight) - (Basic Empty Weight) = Useful Load

Normal Category (2447 lbs) - ( **1575.2** lbs) = **871.8** lbs.

Utility Category (2027 lbs) - ( **1575.2** lbs) = **451.8** lbs.

THIS BASIC EMPTY WEIGHT, C.G. AND USEFUL LOAD ARE FOR THE AIRPLANE AS LICENSED AT THE FACTORY. REFER TO APPROPRIATE AIRCRAFT RECORD WHEN ALTERATIONS HAVE BEEN MADE.

## WEIGHT AND BALANCE DATA FORM

Figure 6-5

REPORT: VB-1610

ISSUED: JULY 12, 1995

6-7

**THIS PAGE INTENTIONALLY LEFT BLANK**

PA-28-161		Serial Number 2842158		Registration Number N53453			Page Number	
Date	Item No.	Description of Article or Modification	Added (+) Removed (-)	Weight Change			Running Basic Empty Weight	
				Wt. (Lb.)	Arm (In.)	Moment /100	Wt. (Lb.)	Moment /100
05/09/02		As licensed					1575.2	136658.7

## WEIGHT AND BALANCE RECORD

Figure 6-7

ISSUED: JULY 12, 1995

REPORT: VB-1610

6-9



**6.7 WEIGHT AND BALANCE DETERMINATION FOR FLIGHT**

- (a) Add the weight of all items to be loaded to the basic empty weight.
- (b) Use the Loading Graph (Figure 6-13) to determine the moment of all items to be carried in the airplane.
- (c) Add the moment of all items to be loaded to the basic empty weight moment.
- (d) Divide the total moment by the total weight to determine the C.G. location.
- (e) By using the figures of item (a) and item (d) (above), locate a point on the C.G. range and weight graph (Figure 6-15). If the point falls within the C.G. envelope, the loading meets the weight and balance requirements.

	Weight (Lbs)	Arm Aft Datum (Inches)	Moment (In-Lbs)
Basic Empty Weight	1500.0	85.9	128850
Pilot and Front Passenger	340.0	80.5	27370
Passengers (Rear Seats)*	340.0	118.1	40154
Fuel (48 Gallon Maximum)	267.0	95.0	25365
Baggage* (200 Lbs. Maximum)		142.8	
Ramp Weight (2447 Lbs. Normal, 2027 Lbs. Utility Maximum)	2447.0	90.6	221739
Fuel Allowance For Engine Start, Taxi and Run Up	-7.0	95.0	-665
Takeoff Weight (2440 Lbs. Normal, 2020 Lbs. Utility Maximum)	2440.0	90.6	221074

The center of gravity (C.G.) of this sample loading problem is at 90.6 inches aft of the datum line. Locate this point (90.6) on the C.G. range and weight graph. Since this point falls within the weight - C.G. envelope, this loading meets the weight and balance requirements.

**IT IS THE RESPONSIBILITY OF THE PILOT AND AIRCRAFT OWNER TO INSURE THAT THE AIRPLANE IS LOADED PROPERLY.**

\*Utility Category Operation - No baggage or aft passengers allowed.

**SAMPLE LOADING PROBLEM (NORMAL CATEGORY)**

Figure 6-9

**SECTION 6**  
**WEIGHT AND BALANCE**

**PA-28-161, WARRIOR III**

	Weight (Lbs)	Arm Aft Datum (Inches)	Moment (In-Lbs)
Basic Empty Weight			
Pilot and Front Passenger		80.5	
Passengers (Rear Seats)*		118.1	
Fuel (48 Gallon Maximum)		95.0	
Baggage* (200 Lbs. Maximum)		142.8	
Ramp Weight (2447 Lbs. Normal, 2027 Lbs. Utility Maximum)			
Fuel Allowance For Engine Start, Taxi and Run Up	-7	95.0	-665
Takeoff Weight (2440 Lbs. Normal, 2020 Lbs. Utility Maximum)			

Totals must be within approved weight and C.G. limits. It is the responsibility of the airplane owner and the pilot to insure that the airplane is loaded properly. The Basic Empty Weight C.G. is noted on the Weight and Balance Data Form (Figure 6-5). If the airplane has been altered, refer to the Weight and Balance Record for this information.

\*Utility Category Operation - No baggage or aft passengers allowed.

**WEIGHT AND BALANCE LOADING FORM**

Figure 6-11

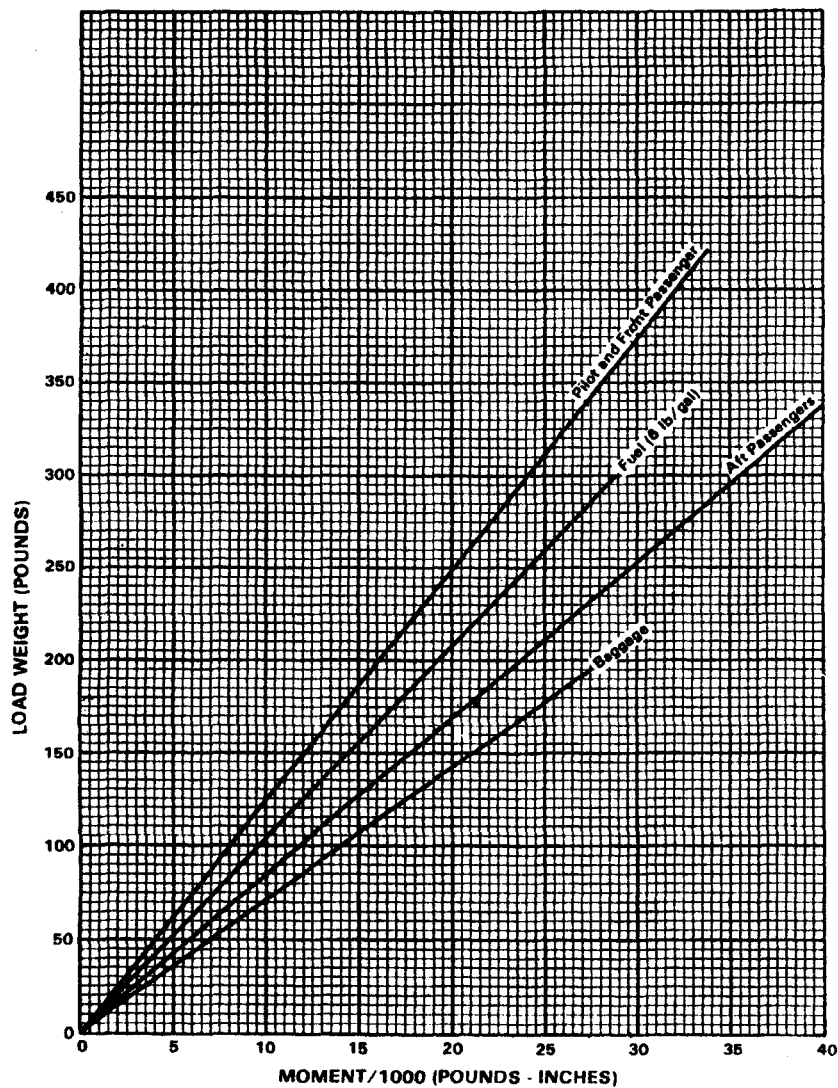

LOADING GRAPH  
Figure 6-13

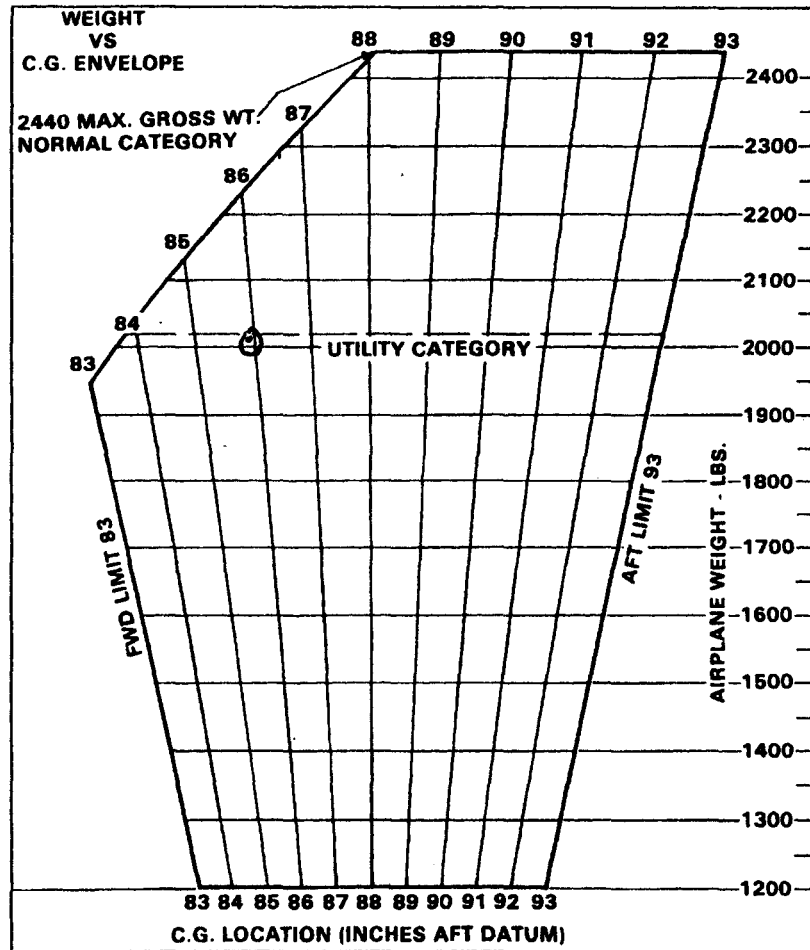

**C.G. RANGE AND WEIGHT**  
Figure 6-15





THE NEW PIPER AIRCRAFT, INC.

PA-28-161, WARRIOR III  
EQUIPMENT LIST  
S/N 2842109 and UP

EQUIPMENT LIST

The following is a list of standard and optional equipment for the PA-28-161 Warrior III. Optional equipment items marked with an X are installed on the airplane. All items are as described below at the time of licensing by the manufacturer. The New Piper Aircraft, Inc. will not revise this equipment list once the aircraft is licensed. It is the owner's responsibility to retain and amend this equipment list to reflect changes in equipment installed in this airplane. Unless otherwise indicated, the installation certification basis for the equipment included in this list is the aircraft's approved type design.

THE NEW PIPER AIRCRAFT, INC.

PA-28-161, WARRIOR III

SERIAL NO. 2842158      REGISTRATION NO. N53453      DATE 05/06/02

Item No.	Item	Weight (Pounds)	Arm (In.) Aft Datum	Moment (Lb-In.)
<b>(a) Propeller and Propeller Accessories</b>				
1.	Propeller, Sensenich 74DM6-0-60, Piper PS50077-34, Cert. Basis -TC P886	32.4	3.3	106.9
3.	Spinner Dome and Bulkhead, Piper Drawing 87325	3.3	2.8	9.2
<b>(b) Engine and Engine Accessories, Fuel and Oil Systems</b>				
5.	Engine, Textron Lycoming Model O-320-D3G Cert. Basis-TC E274	281.0	21.3	5985.3
7.	Alternator, 60 Amp, Electro Systems Inc. ALU842ILS, Lycoming 32C19553A	12.0	14.0	168.0
9.	Starter, 24 volt Lycoming, ESI MHB4016, Lycoming LW15572 Cert. Basis TC E274 (weight included in engine weight)	18.0	14.5	261.0
11.	Engine Driven Fuel Pump, Lycoming Drawing 75246 Cert. Basis - TC E274	1.7	36.3	61.7
13.	Electric Fuel Pump, Facet Model 476088	1.8	45.0	81.0
15.	Primer System, Piper Drawing 89367-4	1.2	50.0	60.0
17.	Fuel Valve, Piper Drawing 66945, System Components Corp. SP-2378-B3, Or Allen Aircraft Products Inc. 6S122	0.4	61.9	24.8
21.	Oil Cooler, Niagara N.D.M.20002A, Piper Drawing 18622 (wet)	2.6	41.3	107.4
23.	Oil Filter, Cert. Basis - TCE274			
	a. Lycoming 75528, AC OF5578770	3.3	35.3	116.5
	b. Lycoming LW-13743, Champion CH-48110	2.8	35.3	98.8



THE NEW PIPER AIRCRAFT, INC.

PA-28-161, WARRIOR III  
EQUIPMENT LIST  
S/N 2842109 and UP

Item No.	Item	Weight (Pounds)	Arm (In.) Aft Datum	Moment (Lb.-In.)
<b>(b) Engine and Engine Accessories, Fuel and Oil Systems</b>				
25.	Air Filter, Piper Drawing 35477	0.9	29.5	26.6
<b>(c) Landing Gear and Brakes</b>				
27.	Main Landing Gear Cleveland Aircraft Products Wheel Assembly (2), 40-86B, Piper PS50035-9 Brake Assembly 30-55 (2) Piper PS50121-1, Cert. Basis-TSO C26a 6.00 x 6 Type III 4 Ply Rating Tire, Piper PS50119-11 and Tubes (2), Piper PS50119-101, Cert. Basis - TSO C62d	38.8	109.6	4252.5
29.	Nose Wheel Assembly a. Cleveland Aircraft Products Wheel Assembly 40-77B, Piper PS50035-24 Cert. Basis TSO C26a b. 5.00-5 Type III 4 Ply Rating Tire, Piper PS50119-9 and Tube, Piper PS50119-100, Cert. Basis TSO C62d	3.0 6.8	30.8 30.8	92.4 209.4
31.	Hand Brake Master Cylinder, Piper Drawing 65842 (Cleveland Aircraft Products 10-22)	0.6	60.9	36.5
33.	Toe Brake Cylinders a. Cleveland Aircraft Products 10-27 b. Gar-Kenyon Instruments 17000	0.7 0.4	53.0 53.0	37.1 21.2
<b>(d) Electrical Equipment</b>				
35.	Battery, 28 volt Gill G-243	28.0	43.2	1209.6
37.	Voltage Regulator, Piper Drawing 68804-5	0.4	51.9	20.8
39.	Starter Relay, 28V (RBM Controls 70-117224-3), Piper Drawing 26898-5	0.8	180.0	144.0
41.	Stall Warning Devices (Safe Flight C52207), Piper Drawing 35544	0.2	80.2	16.0
43.	Stall Warning Horn (Safe Flight 53534-3) Piper Drawing 35214-9	0.2	58.8	11.8
45.	Radio Master Switch Relay 6041H299, Piper Drawing 39870-9	0.5	59.5	29.8
47.	Instrument Panel Lights Installation, Piper Drawing 85360	0.3	62.8	18.8
49.	Cabin Light, Piper Drawing 87499-6	0.3	99.0	29.7



THE NEW PIPER AIRCRAFT, INC.

PA-28-161, WARRIOR III  
EQUIPMENT LIST  
S/N 2842109 and UP

Item No.	Item	Weight (Pounds)	Arm (In.) Aft Datum	Moment (Lb-In.)
<b>(d) Electrical Equipment - continued</b>				
51.	Landing Light (G.E. Model 4594)	0.5	13.1	6.6
53.	Navigation Lights (Wings) (2), Red/White and Green/White with White Strobe, Whelen Power Supply A413HDA-CF-14/28	6.6	106.6	703.6
55.	Auxiliary Power Receptacle, Piper Drawing 85421-2	2.7	178.5	482.0
57.	Heated Pitot Installation, Piper Drawing 35493-19,20	0.4	100.0	40.0
<b>(e) Instruments</b>				
61.	Truspeed Airspeed Indicator, Piper PS50049-41T Cert. Basis TSO C2b	0.6	61.8	37.1
63.	Altimeter, Piper PS50008-10-2 (United Instruments U15934-PD-I) Cert. Basis TSO C10b	0.9	60.9	54.8
65.	Compass, Magnetic, Piper Drawing 67462-08 (Airpath C-2200-L4-B) Cert. Basis TSO C7c	0.9	64.6	58.1
67.	Tachometer, Piper PS50048-15-1	0.7	61.2	42.8
69.	Oil press./Cylinder temp./Oil temp, Piper PS50160-7	1.0	62.2	62.2
71.	Fuel Quantity Indicator, Piper PS50161-6	0.5	62.2	31.1
73.	Attitude Indicator, Piper Drawing 99002-9 (RCA 22-15) Cert. Basis TSO C4c	2.8	59.9	167.7
75.	Directional Gyro, Piper PS50126-5, Cert. Basis TSO C5c	2.4	59.7	143.3
77.	Narco AR-850 Encoder Installation, Piper Drawing 79658-004, Cert. Basis TSO C88(a)			
	a. Narco AR -850 Altitude Reporter 03753-0500, Piper PS50040-30-5, Piper Code 599-012	0.57	51.038	29.04
	b. Narco AR -850 Altitude Reporter Mounting Tray 53873-0102, Piper Code 599-012	0.08	51.038	4.08
	c. Altitude Reporter Hose, Tube and Hardware, Piper Drawing 79658-004	0.14	54.47	7.39
79.	Rate of Climb, Piper Drawing 99010-5 (United Instruments UI-7000) Cert. Basis-TSO C8b	0.7	60.9	42.6
81.	Alternate Static Source Installation, Piper Drawing 35493-21	0.4	61.0	24.4



THE NEW PIPER AIRCRAFT, INC.

PA-28-161, WARRIOR III  
EQUIPMENT LIST  
S/N 2842109 and UP

Item No.	Item	Weight (Pounds)	Arm (In.) Aft Datum	Moment (Lb-In.)
<b>(e) Instruments - continued</b>				
83.	Vacuum Installation 85434-2			
	a. Dry Air Pump, Parker Hannifin AM215CC, Piper Drawing 79399-3, Piper Code Number 461-754	1.90	33.47	63.46
	b. Vacuum Regulator, Parker Hannifin ARM-AM-2H3-19, Piper Code Number 492-240	0.44	48.85	21.47
	c. Hoses, Fittings and Hardware, Piper Drawing 85434-2	2.54	49.33	125.07
85.	Turn Coordinator, Piper PS50030-3-5, Cert. Basis TSO C3b	1.2	59.7	71.6
87.	Engine Hour Meter, Piper Drawing 87346-6	0.3	62.0	18.6
89.	Outside Air temperature Gauge (Rochester Gauge 1592-82042) Piper Drawing 99479-3	0.3	72.6	21.8
91.	Ammeter, Digital EIL Instruments PM-349(548-885)	0.3	61.1	18.3
<b>(f) Cabin Interior</b>				
101.	Pilot Adjustable Seat (Vinyl/Cloth), Piper Drawing 89026-2	22.39	82.90	1856.13
103.	Copilot Adjustable Seat (Vinyl/Cloth), Piper Drawing 89026-2	22.62	82.69	1870.44
105.	Rear Bench Seat (Vinyl/Cloth), Piper Drawings 35131-0, 89039-4 and 89038-4	25.7	124.1	3189.4
107.	Pilot restraint system, Piper Drawing 35131-0, Cert. Basis TSO-C114/JTSO-C114			
	a. Pilot Inertia Reel, Schroth 5-01-1F0701, Piper Code 564-897, Piper Drawing 104211-014	1.29	119.50	154.39
	b. Pilot Stiffening Sleeve, Schroth 5-01-1F0701, Piper Code 564-897, Piper Drawing 104211-014	0.29	84.00	24.32
109.	CoPilot Restraint System, Piper Drawing 35131-0, Cert. Basis TSO-C114/JTSO-C114			
	a. CoPilot Inertia Reel, Schroth 5-01-1F5701, Piper Code 564-896, Piper Drawing 104211-015	1.30	119.50	154.87
	b. CoPilot Stiffening Sleeve, Schroth 5-01-1F5701, Piper Code 564-896, Piper Drawing 104211-015	0.29	84.00	24.19
111.	Bench, Aft Seat Restraint System (LH), Piper Drawing 35131-0 Cert. Basis TSO-C114/JTSO-C114			
	a. Aft Seat Inertia Reel, Schroth 5-01-480701, Piper Code 564-895, Piper Drawing 104211-012	1.23	140.30	173.13
	b. Aft Seat Inertia Reel, Schroth 5-01-480701, Piper Code Number 564-895, Piper Drawing 104211-012	0.26	123.00	31.67



THE NEW PIPER AIRCRAFT, INC.

PA-28-161, WARRIOR III  
EQUIPMENT LIST  
S/N 2842109 and UP

Item No.	Item	Weight (Pounds)	Arm (In.) Aft Datum	Moment (Lb-In.)
<b>(f) Cabin Interior - continued</b>				
113.	Bench, Aft Seat Restraint System (RH), Piper Drawing 35131-0, Cert. Basis TSO-C114/JTSO-C114			
	a. Aft Seat Inertia Reel, Schroth 5-01-285701, Piper Code 564-893, Piper Drawing 104211-003	1.23	140.30	173.20
	b. Aft Seat Stiffening Sleeve, Schroth 5-01-285701, Piper Code 564-893, Piper Drawing 104211-003	0.26	123.00	31.49
115.	Assist Strap, Piper Drawing 79455-0	0.2	109.5	21.9
117.	Baggage Straps, Piper Drawings 66804-0 & 66805-0	1.3	142.8	185.6
119.	Sun Visors Installation, Piper Drawing 66991-12	1.5	75.1	112.7
<b>(g) Miscellaneous</b>				
121.	Assist Step, Piper Drawing 65384-0	1.8	156.0	280.8
123.	Auxiliary Vacuum Pump Installation, Piper Drawing 85386-2			
	a. Standby Auxiliary Vacuum Pump, Parker Hannifin 4A2-1, Piper Code 566-527	7.12	43.74	311.41
	b. Hardware, Parker Hannifin Kit 374-10, Piper Code 566-527	2.07	45.66	94.56
	c. Brackets and Hardware, Piper Drawing 85386-2	3.18	45.79	145.46
125.	Fire Extinguisher Installation 82235-2			
	a. Saber Halon 1211-1301 Fire Extinguisher Model 600 and Installation hardware	2.1	95.8	201.2
127.	Ram Air Installation, Piper Drawing 36983-002			
	a. Ram Air Installation	2.874	191.047	548.978
<b>(h) Standard Avionics Equipment</b>				
131.	Garmin GNS 430 GPS/Nav/Com (11-33 Vdc) Piper Drawing 104618-002			
	a. Garmin GNS430 (11-33Vdc) with mount, connectors and data card, Piper PS50040-40-4, Piper Code 601-229, Cert. Basis TSO C37d, C38d, C40c, C36e, C34e, C129a	6.56	58.138	381.18
	b. Cables/Harnesses and Hardware, Piper Drawing 104618-002	2.01	55.621	112.007
133.	Garmin GI-106 VOR /LOC Indicator, Piper Code 602-239, Cert. Basis-TSO C36c, C40a, C34c	1.02	60.228	61.43



THE NEW PIPER AIRCRAFT, INC.

PA-28-161, WARRIOR III  
EQUIPMENT LIST  
S/N 2842109 and UP

Item No.	Item	Weight (Pounds)	Arm (In.) Aft Datum	Moment (Lb-In.)
<b>(h) Standard Avionics Equipment - continued</b>				
135.	Garmin GTX-327 Transponder Installation, Piper Drawing 104251-2, Cert. Basis TSO C74C			
	a. Garmin GTX327 Transponder Unit 011-00490-10, Piper PS50040-12-12, Piper Code 651-938	2.90	59.238	171.79
	b. Garmin Connector/Rack Kit 011-00338-00, Piper PS50040-12-12, Piper Code 651-938	0.64	59.238	37.91
	c. Garmin Transponder Antenna 010-10160-00, Piper Code 683-724	0.21	55.11	11.5731
	d. Harness, Backing Plate, and Hardware, Piper Drawing 104251-2	1.10	53.35	58.77
137.	Garmin Audio Amp/Marker Installation, Piper Drawing 101193-004, Cert. Basis TSO C35d and C50b			
	a. Garmin GMA 340 Audio Selector Panel, Piper PS50040-15-25, Piper Code 601-210			
	1. Garmin 011-00401-10 GMA Audio Panel Marker /Receiver	1.57	59.84	93.95
	2. Garmin 011-00403-00 Connector/Rack Kit	0.17	59.84	10.17
	b. Harnesses, Brackets and Hardware, Piper Drawing 101193-4	2.39	74.96	179.19
139.	Emergency Locator Transmitter Installation, Piper Drawing 06327-009, Cert. Basis TSO C91a			
	a. Artex ELT 110-4 Kit, Piper Code 599-515			
	1. Artex Transmitter 110-4 Unit/Bracket, Piper Code 599-515	4.260	236.750	1008.555
	2. Antenna Artex 110-324, Piper Code 599-515	0.090	208.880	18.799
	3. Coax Cable Artex 611-6013, Piper Code 599-515	0.140	222.820	31.195
	4. Remote Switch Artex 645-6196, Piper Code 599-515	0.070	62.438	4.371
	b. Harness and Hardware, Piper Drawing 06327-009	0.885	190.401	168.595
141.	Antennas			
	a. NAV Receiving AV12-PPR Antenna, Piper Code 451-802	0.40	264.9	105.96
	1. Nav Antenna Cable Assembly and Hardware, Piper Drawing 101311-002	0.862	169.431	146.02
	b. VHF Comm Comant CI-121 Antenna, Piper PS50040-18-2, Piper Code 596-664	0.543	158.500	85.986
	1. Comm Antenna Cable Assy and Hardware, Piper Drawing 101311002	0.802	99.892	80.114
	c. Comant CI-507 Antenna Coupler, Piper Code 557-704	0.163	54.938	8.955
	1. Antenna Coupler Hardware, Piper Drawing 101311-002	0.007	58.938	0.383
	d. Installation Hardware, Piper Drawing 101311-002	0.069	67.454	4.660
	e. GPS Antenna (Single) Installation, Piper Drawing 101273-2			
	1. Garmin 010-10040-01 Antenna Kit 683-721			
	a. Garmin 011-00134-00 GA56 Antenna, Piper Code 683-721	0.24	96.26	23.29
	b. Garmin 115-00031-00 Backing Plate, Piper Code 683-721	0.09	96.26	8.47088
	2. Coax Cable, Piper Drawing 101265-005	0.52	77.98	40.78
143.	Marker Beacon Antenna Installation, Piper Drawing 39737-004			
	a. Marker Beacon Antenna Comant CI-102, Piper PS50040-15-10, Piper Code 597-893	0.45	217.17	98.60
	b. Marker Beacon Cable and Hardware, Piper Drawing 39737-004	1.08	122.559	132.50



THE NEW PIPER AIRCRAFT, INC.

PA-28-161, WARRIOR III  
EQUIPMENT LIST  
S/N 2842109 and UP

No.	Item	Mark if Option Installed	Weight (Pounds)	Arm (In.) Aft Datum	Moment (Lb-In.)
<b>(h) Standard Avionics Equipment - continued</b>					
145.	Clock (electric), Piper Drawing 87347-2		0.4	62.4	25.0
147.	Avionics Cooling Blower Installation, Piper Drawing 101318-2				
	a. Troll Avionics Icebox FN-200, PSV 4000020 Blower, Piper Code 460-110		1.07	56.54	60.44
	b. Cable, Bracket and Hardware, Piper Drawing 101318-002		0.53	54.71	29.02
149.	Cabin Speaker Assembly, Piper Drawing 99220-003				
	a. Speakers (2), Oaktron 6FU321, Piper Code 585-015		2.312	88.18	203.83
	b. Harness and Hardware, Piper Drawing 99220-003		0.249	88.18	21.91
151.	Pilot's Microphone				
	a. Telex 100T/NH Microphone 62800-001, Piper Code 474-657		0.26	74.13	19.35
	b. Telex Holder 64022-000 and Hardware, Piper Drawing 79036-024		0.03	74.13	2.34
152.	Pilot's Headset				
	a. Telex 5161A Airman 760 Headset, Piper Code 692-205		0.20	80.5	16.34
153.	Pilot Mike Switch Assembly, Piper Drawing 101117-005		0.093	68.938	6.399
155.	CoPilot Mike Switch Assembly, Piper Drawing 101117-006		0.093	68.938	6.399

END OF STANDARD EQUIPMENT

**(i) Optional Electrical Equipment**

173.	Tail Light Assembly, Piper Drawing 63886-4	<input type="checkbox"/>	0.4	281.0	112.4
175.	Wing Tip Recognition Lights, Piper Drawing 87487-7	<input type="checkbox"/>	1.0	94.1	94.1
177.	Tail Strobe(low profile) Installation, Piper Drawing 104296-004				
	a. Strobe Light, Whelen 01-0790111-02, Piper Code 683-504	<input type="checkbox"/>	0.24	243.79	58.63
	b. Cables/Harnesses and Hardware, Piper Drawing 104296-004	<input type="checkbox"/>	1.29	195.03	251.26
	<b>Tail Strobe Installation Total Weight</b>		1.53	202.70	309.89



THE NEW PIPER AIRCRAFT, INC.

PA-28-161, WARRIOR III  
EQUIPMENT LIST  
S/N 2842109 and UP

No.	Item	Mark if Option Installed	Weight (Pounds)	Arm (In.) Aft Datum	Moment (Lb-In.)
<b>(j) Optional Avionics Equipment</b>					
181.	Garmin Dual GNS 430 GPS/Nav/Com (11-33 Vdc), Piper Drawing 104618-004				
	a. Garmin GNS430 (11-33 Vdc) #1 with mount, connectors and data card, Piper PS50040-40-4, Piper Code 601-229	<input type="checkbox"/>	6.56	58.138	381.18
	b. Garmin GNS430 (11-33 Vdc) #2 with mount, connectors and data card, Piper PS50040-40-4, Piper Code 601-229	<input type="checkbox"/>	6.56	58.138	381.18
	c. Garmin GI-106 Indicator #2, Piper Code 602-239	<input type="checkbox"/>	1.02	60.228	61.43
	d. Cables/Harnesses and Hardware, Piper Drawing 104618-004	<input type="checkbox"/>	4.045	55.524	224.572
	Removed Standard GNS 430 (11-33 Vdc) System Installation 104618-002		-8.57	57.547	-493.19
	<b>Delta System Weight</b>		9.61	57.787	555.18
183.	Garmin Dual GNS 430 GPS/Nav/Com (11-33 Vdc),With DME Provisions, Piper Drawing 104618-005				
	a. Garmin GNS430 (11-33 Vdc) #1 with mount, connectors and data card, Piper PS50040-40-4, Piper Code 601-229	<input checked="" type="checkbox"/>	6.56	58.138	381.18
	b. Garmin GNS430 (11-33 Vdc) #2 with mount, connectors and data card, Piper PS50040-40-4, Piper Code 601-229	<input checked="" type="checkbox"/>	6.56	58.138	381.18
	c. Garmin GI-106 Indicator #1, Piper Code 602-239	<input checked="" type="checkbox"/>	1.02	60.23	61.43
	d. Cables/Harnesses and Hardware, Piper Drawing 104618-005	<input checked="" type="checkbox"/>	4.297	55.499	238.485
	Removed Standard GNS430 (11-33 Vdc) System Installation 104618-002		-8.57	57.547	-493.19
	<b>Delta System Weight</b>		9.86	57.718	569.09
185.	Garmin Dual GNS 430 GPS/Nav/Com (11-33 Vdc),With HSI Provisions, Piper Drawing 104618-006				
	a. Garmin GNS430 (11-33 Vdc) #1 with mount, connectors and data card, Piper PS50040-40-4, Piper Code 601-229	<input type="checkbox"/>	6.56	58.138	381.18
	b. Garmin GNS430 (11-33 Vdc) #2 with mount, connectors and data card, Piper PS50040-40-4, Piper Code 601-229	<input type="checkbox"/>	6.56	58.138	381.18
	c. Cables/Harnesses and Hardware, Piper Drawing 104618-006	<input type="checkbox"/>	4.189	55.494	232.439
	Removed Standard GNS430 (11-33 Vdc) System Installation 104618-002		-8.57	57.547	-493.19
	<b>Delta System Weight</b>		8.73	57.450	501.61





THE NEW PIPER AIRCRAFT, INC.

PA-28-161, WARRIOR III  
EQUIPMENT LIST  
S/N 2842109 and UP

No.	Item	Mark if Option Installed	Weight (Pounds)	Arm (In.) Aft Datum	Moment (Lb-In.)
<b>(j) Optional Avionics Equipment - continued</b>					
187.	Garmin Dual GNS 430 GPS/Nav/Com Installation (11-33 Vdc) With HSI and DME Provisions, Piper Drawing 104618-007				
	a. Garmin GNS430 (11-33 Vdc) #1 with mount, connectors and data card, Piper PS50040-40-4, Piper Code 601-229	<input type="checkbox"/>	6.56	58.138	381.18
	b. Garmin GNS430 (11-33 Vdc) #2 with mount, connectors and data card, Piper PS50040-40-4, Piper Code 601-229	<input type="checkbox"/>	6.56	58.138	381.18
	c. Cables/Harnesses and Hardware, Piper Drawing 104618-007	<input type="checkbox"/>	4.31	55.4833	238.91
	Removed Standard GNS430 (11-33 Vdc) System Installation 104618-002		-8.57	57.55	-493.19
	<b>Delta Weight</b>		8.85	57.42	508.09
189.	Garmin GTX-327 Transponder Installation (GPS-Dual), Piper Drawing 104251-3				
	a. Garmin GTX327 Transponder Unit 011-00490-10, Piper PS50040-12-12, Piper Code 651-938	<input checked="" type="checkbox"/>	2.90	59.238	171.79
	b. Garmin Connector/Rack Kit 011-00338-00, Piper PS50040-12-12, Piper Code 651-938	<input checked="" type="checkbox"/>	0.64	59.238	37.91
	c. Garmin Transponder Antenna 010-10160-00, Piper Code 683-724	<input checked="" type="checkbox"/>	0.21	55.11	11.5731
	d. Harness, Backing plate, and Hardware, Piper Drawing 104251-3	<input checked="" type="checkbox"/>	1.47	52.96	77.94
	Removed Standard GTX-327 Installation, Piper Drawing 104251-2		-4.85	57.72	-280.04
	<b>Delta Weight</b>		0.37	51.80	19.17
193.	S-TEC DME 451 with /450 Indicator Installation, Piper Drawing 101245-4				
	a. S-TEC DME Installation Kit PS50040-31-26 Piper Code 601-212				
	1. S-TEC Transceiver TCR-451, 690109	<input checked="" type="checkbox"/>	4.80	200.70	963.36
	2. S-TEC Transceiver Installation Kit, 690224	<input checked="" type="checkbox"/>	0.69	200.70	137.88
	3. S-TEC Indicator IND-450, 690111-P	<input checked="" type="checkbox"/>	0.54	60.44	32.70
	4. S-TEC Indicator Installation Kit, 690221	<input checked="" type="checkbox"/>	0.08	60.44	4.82
	5. S-TEC Antenna ANT-451, 690126	<input checked="" type="checkbox"/>	0.19	123.74	23.88
	6. S-TEC Antenna Installation Kit, 690218	<input checked="" type="checkbox"/>	0.05	123.74	5.88
	b. Harness and Hardware, Piper Drawing 101245-004	<input checked="" type="checkbox"/>	3.60	124.66	448.65
	<b>S-TEC DME 451 with /450 Indicator Installation Total Weight</b>		9.95	162.58	1617.16



THE NEW PIPER AIRCRAFT, INC.

PA-28-161, WARRIOR III  
EQUIPMENT LIST  
S/N 2842109 and UP

No.	Item	Mark if Option Installed	Weight (Pounds)	Arm (In.) Aft Datum	Moment (Lb.-In.)
<b>(j) Optional Avionics Equipment - continued</b>					
195.	S-TEC ADF RCR-650A Installation, Piper Drawing 101195-2				
	a. S-TEC ADF Kit (RCR-650A), Piper PS50040-31-27, Piper Code 601-213				
	1. S-TEC Receiver RCR-650A, 690108-P	<input type="checkbox"/>	2.44	58.04	141.61
	2. S-TEC Receiver Installation Kit, 690212	<input type="checkbox"/>	0.55	61.24	33.68
	3. S-TEC Indicator IND-650A, 690113-P	<input type="checkbox"/>	0.66	61.24	40.42
	4. S-TEC Indicator Installation Kit, 690217	<input type="checkbox"/>	0.18	61.24	11.02
	5. S-TEC Antenna ANT-650A, 690124	<input type="checkbox"/>	2.28	162.76	371.09
	6. S-TEC Antenna Installation Kit, 690215	<input type="checkbox"/>	0.02	161.78	3.24
	7. S-TEC Power Adapter, 01255	<input type="checkbox"/>	0.52	164.50	85.54
	b. Harness, Bracket and Hardware, Piper Drawing 101195-002	<input type="checkbox"/>	3.22	89.90	289.83
	<b>S-TEC ADF RCR-650A Installation Total Weight</b>		9.87	98.89	976.43
197.	S-TEC ADF RCR 650D Installation, Piper Drawing 101195-3				
	a. S-TEC ADF Kit (RCR 650D), Piper PS50040-31-27, Piper Code 652-168				
	1. S-TEC Receiver RCR 650D, p/n 690108-4	<input checked="" type="checkbox"/>	2.484	58.04	144.17
	2. S-TEC Receiver Installation Kit, p/n 690212	<input checked="" type="checkbox"/>	0.55	61.238	33.6809
	3. S-TEC Indicator IND 650D, p/n 690113-P	<input checked="" type="checkbox"/>	0.66	61.238	40.4171
	4. S-TEC Indicator Installation Kit, p/n 690217	<input checked="" type="checkbox"/>	0.18	61.238	11.0228
	5. S-TEC Antenna ANT 650D, p/n 690124	<input checked="" type="checkbox"/>	2.28	162.76	371.093
	6. S-TEC Antenna Installation Kit, p/n 690215	<input checked="" type="checkbox"/>	0.02	161.78	3.2356
	7. S-TEC Power Adapter, p/n 01255	<input checked="" type="checkbox"/>	0.52	164.5	85.54
	b. Harness, Bracket and Hardware, Piper Drawing 101195-3	<input checked="" type="checkbox"/>	3.22	89.894	289.76
	<b>S-TEC ADF RCR 650D Installation Total Weight</b>		9.917	98.71	978.914
199.	Compass ST-180/ HSI Installation, Piper Drawing 101259-006				
	a. S-TEC 6443-PA Horizontal Situation Indicator	<input type="checkbox"/>	2.900	57.19	165.85
	b. S-TEC 6444 Remote Gyro	<input type="checkbox"/>	3.400	186.58	634.39
	c. S-TEC 01171-P Slaving Panel	<input type="checkbox"/>	0.100	60.94	6.09
	d. S-TEC 6446 Flux Sensor	<input type="checkbox"/>	0.300	104.06	31.22
	e. S-TEC 90480-1 Hardware Installation Kit	<input type="checkbox"/>	0.630	58.94	37.13
	g. Harnesses, Brackets and Hardware, Piper Drawing 101259-006	<input type="checkbox"/>	5.55	123.39	685.28
	Removed Standard Directional Gyro, Piper Drawing, Piper PS50126-5		-2.40	59.70	-143.30
	<b>Delta System Weight</b>		10.48	135.13	1416.65



THE NEW PIPER AIRCRAFT, INC.

PA-28-161, WARRIOR III  
EQUIPMENT LIST  
S/N 2842109 and UP

No.	Item	Mark if Option Installed	Weight (Pounds)	Arm (In.) Aft Datum	Moment (Lb-In.)
<b>(j) Optional Avionics Equipment - continued</b>					
201.	Antenna Installation, GPS Dual and Dual Com, Piper Drawing 101311-003				
	a. NAV Receiving AV12-PPR Antenna, Piper Code 451-802	<input checked="" type="checkbox"/>	0.40	264.90	105.96
	1. Nav Antenna Cable Assembly and Hardware, Piper Drawing 101311-003	<input checked="" type="checkbox"/>	0.862	169.431	146.02
	b. VHF Comm Comant CI-121 Antenna, Piper PS50040-18-2, Piper Code Number 596-664	<input checked="" type="checkbox"/>	0.54	158.50	85.99
	1. Comm #1 Antenna Cable Assembly and Hardware, Piper Drawing 101311-003	<input checked="" type="checkbox"/>	0.80	99.89	80.11
	c. Comant CI-1125 Antenna Coupler, Piper Code 556-753	<input checked="" type="checkbox"/>	0.19	54.94	10.47
	1. Antenna Coupler Hardware, Piper Drawing 101311-003	<input checked="" type="checkbox"/>	0.01	58.94	0.38
	d. VHF Comm Antenna #2, Comant CI-122, Piper Code 683-725	<input checked="" type="checkbox"/>	0.60	123.36	74.14
	1. Comm #2 Antenna Cable Assembly and Hardware, Piper Drawing 101311-003	<input checked="" type="checkbox"/>	0.71	89.11	63.35
	e. Installation Hardware, Piper Drawing 101311-003	<input checked="" type="checkbox"/>	0.07	66.35	4.58
	f. GPS Antenna (Dual) Installation, Piper Drawing 101273-3				
	1. Garmin 010-10040-01 Antenna Kit #1, 683-721				
	a. Garmin 011-00134-00 GA56 Antenna #1 Piper Code 683-721	<input checked="" type="checkbox"/>	0.24	96.26	23.29
	b. Garmin 115-00031-00 Backing Plate #1, Piper Code 683-721	<input checked="" type="checkbox"/>	0.09	96.26	8.471
	2. Coax cable #1 Piper Drawing 101265-005	<input checked="" type="checkbox"/>	0.52	77.98	40.78
	3. 010-10040-01 Antenna Kit #2, Piper Code 683-721				
	a. Garmin 011-00134-00 GA56 Antenna #2, Piper Code 683-721	<input checked="" type="checkbox"/>	0.24	96.26	23.29
	b. Garmin 115-00031-00 Backing Plate #2, Piper Code 683-721	<input checked="" type="checkbox"/>	0.09	96.26	8.47
	4. Coax Cable #2, Piper Drawing 101266-004	<input checked="" type="checkbox"/>	0.50	77.98	38.99
	Removed Antenna Installation, Single Com/GPS, Piper Drawing 101311-002		-2.84	151.85	-432.01
	<b>Delta Weight</b>		1.34	103.77	139.00
203.	S-TEC Manual Electric Trim Installation, Piper Drawing 100831-2				
	a. S-TEC Trim Servo 0106-11-T6	<input type="checkbox"/>	2.90	113.90	330.31
	b. S-TEC Monitor/Sonalert Trim Monitor 01240	<input type="checkbox"/>	0.30	57.50	17.25
	c. S-TEC Monitor/Sonalert Sonalert 6551	<input type="checkbox"/>	0.10	58.18	5.82
	d. S-TEC Trim Servo Installation Kit Hardware 90402-1	<input type="checkbox"/>	0.58	113.54	66.27
	e. S-TEC Trim Switch and Cable Installation Kit 90402-2	<input type="checkbox"/>	0.80	82.71	66.07
	f. S-TEC Monitor/Sonalert Installation Kit Hardware 90402-3	<input type="checkbox"/>	0.17	58.04	9.90
	g. Harnesses, Brackets and Hardware, Piper Drawing 100831-2	<input type="checkbox"/>	0.54	72.97	39.38
	h. Pilot STEC Trim And Mike Switch Assembly, Piper Drawing 101117-015	<input type="checkbox"/>	0.21	68.94	14.59
	Removed Pilot Mike Switch Assembly, Piper Drawing 101117-005		-0.09	68.94	-6.399
	<b>Delta Weight</b>		5.51	98.56	543.19



THE NEW PIPER AIRCRAFT, INC.

PA-28-161, WARRIOR III  
EQUIPMENT LIST  
S/N 2842109 and UP

No.	Item	Mark if Option Installed	Weight (Pounds)	Arm (In.) Aft Datum	Moment (Lb-In.)
<b>(j) Optional Avionics Equipment - continued</b>					
205.	Avionics Cooling Blower Installation for Dual GNS 430 – 3 Port, Piper Drawing 101318-2				
	a. Troll Avionics Icebox FN-200 PSV 4000020 Blower, Piper Code 460-110	<input checked="" type="checkbox"/>	1.07	56.538	60.44
	b. Cable, Bracket and Hardware, Piper Drawing 101318-2	<input checked="" type="checkbox"/>	0.66	54.6191	36.05
	Removed Standard Avionics Cooling Blower Installation - 3 Port, Piper Drawing 101318-2		-1.60	55.93	-89.46
	<b>Delta Weight</b>		0.13	54.25	7.03
207.	Pilot Boom Mike Headset. (Telex Airman 750) replaces Standard Pilot's Headset 5161A Telex Airman 760				
	a. Pilot's Headset, Telex Airman 750, Piper Code 464-448	<input type="checkbox"/>	0.26	80.5	20.89
	b. Removed Standard Pilot Headset, Telex 5161A Airman 760 Headset, Piper Code 692-205		-0.20	80.5	-16.34
	<b>Delta Weight</b>		0.06	80.500	4.55
<b>(k) Optional Instrumentation Equipment</b>					
211.	Dual Altimeter Installation, Piper Drawing 85518-2, (Altimeter, Piper PS50008-10-2D) Cert. Basis TSO C10b	<input type="checkbox"/>	1.2	60.9	73.1
213.	Carburetor Ice Detector, Piper Drawing 85519-3	<input type="checkbox"/>	0.5	62.1	31.1
<b>(l) Miscellaneous Optional Equipment</b>					
221.	Fresh Air Blower Installation, Piper Drawing 36983-019				
	Blower Assembly, Piper Drawing 79266-002	<input type="checkbox"/>	4.41	197.11	869.23
	Fresh Air Blower Installation Hardware, Piper Drawing 36983-019	<input type="checkbox"/>	5.20	173.56	901.77
	Removed Standard Ram Air Installation, Piper Drawing 36983-002		-2.87	191.05	-548.98
	<b>Delta Weight</b>		6.73	181.52	1222.03
<b>END FACTORY INSTALLED OPTIONS</b>					
<b>TOTAL OPTIONAL EQUIPMENT</b>			<b><u>31.6</u></b>	<b><u>105.3924</u></b>	<b><u>3330.4</u></b>
<b>END OF ORIGINAL EQUIPMENT INSTALLATION</b>					

**TABLE OF CONTENTS**  
**SECTION 7**  
**DESCRIPTION AND OPERATION**  
**OF THE AIRPLANE AND ITS SYSTEMS**

Paragraph No.		Page No.
7.1	The Airplane.....	7-1
7.3	Airframe .....	7-1
7.5	Engine and Propeller .....	7-2
7.7	Landing Gear .....	7-4
7.9	Flight Controls.....	7-5
7.11	Engine Controls.....	7-6
7.13	Fuel System .....	7-8
7.15	Electrical System.....	7-10
7.17	Vacuum System .....	7-13
7.19	Instrument Panel.....	7-15
7.21	Pitot-Static System .....	7-18
7.23	Heating and Ventilating System .....	7-21
7.25	Cabin Features.....	7-21
7.27	Baggage Area .....	7-22
7.29	Stall Warning.....	7-22
7.31	Finish.....	7-22
7.33	Piper External Power.....	7-23
7.35	Emergency Locator Transmitter.....	7-23

**THIS PAGE INTENTIONALLY LEFT BLANK**

**REPORT: VB-1610**

**7-ii**

**SECTION 7****DESCRIPTION AND OPERATION  
OF THE AIRPLANE AND ITS SYSTEMS****7.1 THE AIRPLANE**

The WARRIOR III is a single-engine, fixed gear monoplane of all metal construction with low semi-tapered wings. It has four place seating and a baggage capacity of two hundred pounds.

**7.3 AIRFRAME**

The primary structure, with the exception of the steel tube engine mount, steel landing gear struts and isolated areas, is of aluminum alloy construction. Lightweight plastics are used extensively in the extremities - the wing tips, the engine cowling, etc. - and in nonstructural components throughout the airplane.

The fuselage is a conventional semi-monocoque structure. On the right side of the airplane is a cabin door for entrance and exit. A baggage door is installed aft of the rear seat.

The wing is of a conventional, semi-tapered design incorporating a laminar flow, NACA 652415, airfoil section. The cantilever wings are attached to each side of the fuselage by insertion of the butt ends of the main spars into a spar box carry-through which is an integral part of the fuselage structure. The spar box carry-through structure, located under the rear seat, provides in effect a continuous main spar. The wings are also attached fore and aft of the main spar by an auxiliary front spar and a rear spar. The rear spar, in addition to taking torque and drag loads, provides a mount for flaps and ailerons. The four-position wing flaps are mechanically controlled by a handle located between the front seats. When fully retracted, the right flap locks into place to provide a step for cabin entry. Each wing contains one fuel tank.

A vertical stabilizer, an all-movable horizontal stabilator, and a rudder make up the empennage. The stabilator incorporates an anti-servo tab which improves longitudinal stability and provides longitudinal trim. This tab moves in the same direction as the stabilator, but with increased travel.

### **7.5 ENGINE AND PROPELLER**

The PA-28-161 is powered by a four cylinder, direct drive, horizontally opposed engine rated at 160 HP at 2700 RPM. It is equipped with a starter, a 60 amp 28 volt alternator, a shielded ignition, two magnetos, vacuum pump drive, a fuel pump, and a wetted polyurethane foam induction air filter.

The engine compartment is accessible for inspection through top-hinged side panels on either side of the engine cowlings. The engine cowlings are cantilever structures attached at the fire wall. The engine mounts are constructed of steel tubing, and dynafocal mounts are provided to reduce vibration.

The exhaust system is constructed of stainless steel and incorporates dual mufflers with heater shrouds to supply heated air for the cabin, the defroster system and the carburetor deicing system.

An oil cooler is located on the left rear of the engine mounted to the engine baffling. Engine cooling air, which is picked up in the nose section of the engine cowling and carried through the baffling, is utilized on the left side for the oil cooler. A winterization plate is provided to restrict air during winter operation (refer to Section 8).

Engine air enters on either side of the propeller through openings in a nose cowling and is carried through the engine baffling around the engine and oil cooler. Air for the muffler shroud is also picked up from the nose cowling and carried through a duct to the shroud. Carburetor induction air enters a chin scoop on the lower right cowling and is passed through a wetted polyurethane filter to the carburetor air box. Heated air enters the carburetor air box through a hose connected to the heater shroud.

A fixed pitch propeller is installed as standard equipment. The propeller has a 74-inch diameter with a 60-inch pitch. The pitch is determined at 75% of the diameter. The propeller is made of an aluminum alloy construction.

The pilot should read and follow the procedures recommended in the Lycoming Operator's Manual for this engine in order to obtain maximum engine efficiency and time between engine overhauls.



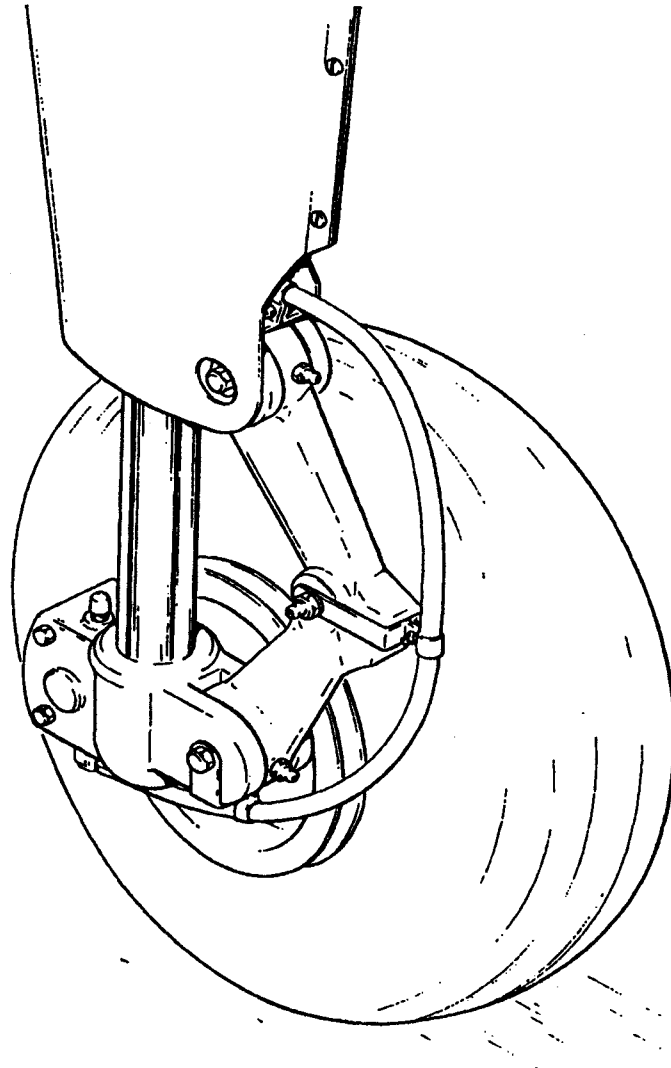

**MAIN WHEEL ASSEMBLY**

Figure 7-1

### **7.7 LANDING GEAR**

The fixed-gear PA-28-161 is equipped with a Cleveland 5.00 x 5 wheel on the nose gear and a Cleveland 6.00 x 6 wheel on each main gear (Figure 7-1). Cleveland single disc hydraulic brake assemblies are provided on the main gear. The nose gear has a 5.00 x 5 four-ply tire, while the main wheel assemblies have 6.00 x 6 four-ply tires. At gross weight, the main gear tires require a pressure of 24 psi, and the nose gear tire requires a pressure of 30 psi.

A spring device is incorporated in the rudder pedal torque tube assembly to provide rudder trim. A bungee in the nose gear steering mechanism reduces steering effort and dampens bumps and shocks during taxiing. By using the rudder pedals and the brakes, the nose gear is steerable through a 30 degree arc each side of center. Later aircraft have the bungee removed from the nose gear steering mechanism and are steerable through a 20 degree arc each side of center. A shimmy dampener is also included in the nose gear.

The three struts are of the air-oil type with the normal static load extension being 3.25 inches for the nose gear and 4.50 inches for the main gear.

The brakes are actuated by toe brake pedals which are attached to the rudder pedals or by a hand lever and master cylinder located below and behind the center of the instrument sub panel. Hydraulic cylinders are located above each pedal and adjacent to the hand brake lever. The brake fluid reservoir is installed on the top left front face of the fire wall. The parking brake is incorporated in the master cylinder and is actuated by pulling back on the brake lever and depressing the knob attached to the left side of the handle. To release the parking brake, pull back on the brake lever to disengage the catch mechanism and allow the handle to swing forward (refer to Figure 7-5).

**FLIGHT CONTROL CONSOLE**

Figure 7-3

### 7.9 FLIGHT CONTROLS

Dual flight controls are provided as standard equipment. The flight controls actuate the control surfaces through a cable system.

The horizontal surface (stabilator) is of the flying tail design with a trim tab mounted on the trailing edge. This tab serves the dual function of providing trim control and pitch control forces. The trim tab is actuated by a trim control wheel located on the control console between the front seats (Figure 7-3). Forward rotation of the wheel gives nose down trim and aft rotation gives nose up trim.

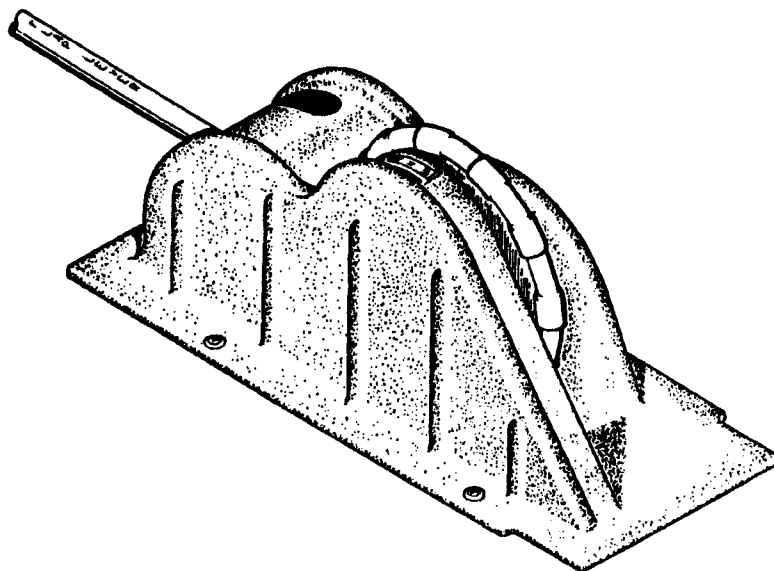
The rudder is conventional in design and incorporates a rudder trim. The trim mechanism is a spring loaded recentering device. The trim control is located on the right side of the pedestal below the throttle quadrant (refer to Figure 7-5). Turning the trim control clockwise gives nose right trim and counterclockwise rotation gives nose left trim.

Manually controlled flaps are provided on the PA-28-161. The flaps are balanced and spring loaded to return to the retracted (up) position. A control handle, which is located between the two front seats on the control console (Figure 7-3), extends the flaps by the use of a control cable. To extend the flaps, the handle is pulled up to the desired flap setting of 10, 25 or 40 degrees. To retract, depress the button on the end of the handle and lower the control. When extending or retracting flaps, there is a pitch change in the airplane. This pitch change can be corrected either by stabilator trim or increased control wheel force. When the flaps are in the retracted (up) position the right flap, provided with an over-center lock mechanism, acts as a step.

**NOTE**

The right flap will support a load only in the fully retracted (up) position. When the flap is to be used as a step, make sure the flaps are in the retracted (up) position.

**7.11 ENGINE CONTROLS**

Engine controls consist of a throttle control and a mixture control lever. These controls are located on the control quadrant on the lower center of the instrument panel (Figure 7-5) where they are accessible to both the pilot and the copilot. The controls utilize teflon-lined control cables to reduce friction and binding.

The throttle lever is used to adjust engine RPM. The mixture control lever is used to adjust the air to fuel ratio. The engine is shut down by the placing of the mixture lever in the full lean position. For information on the leaning procedure, see the Avco-Lycoming Operator's Manual.

The friction adjustment lever on the right side of the control quadrant may be adjusted to increase or decrease the friction holding the throttle and mixture controls or to lock the controls in a selected position.

The carburetor heat control lever is located to the right of the control quadrant on the instrument panel. The control is placarded with two positions: ON (down), OFF (up).

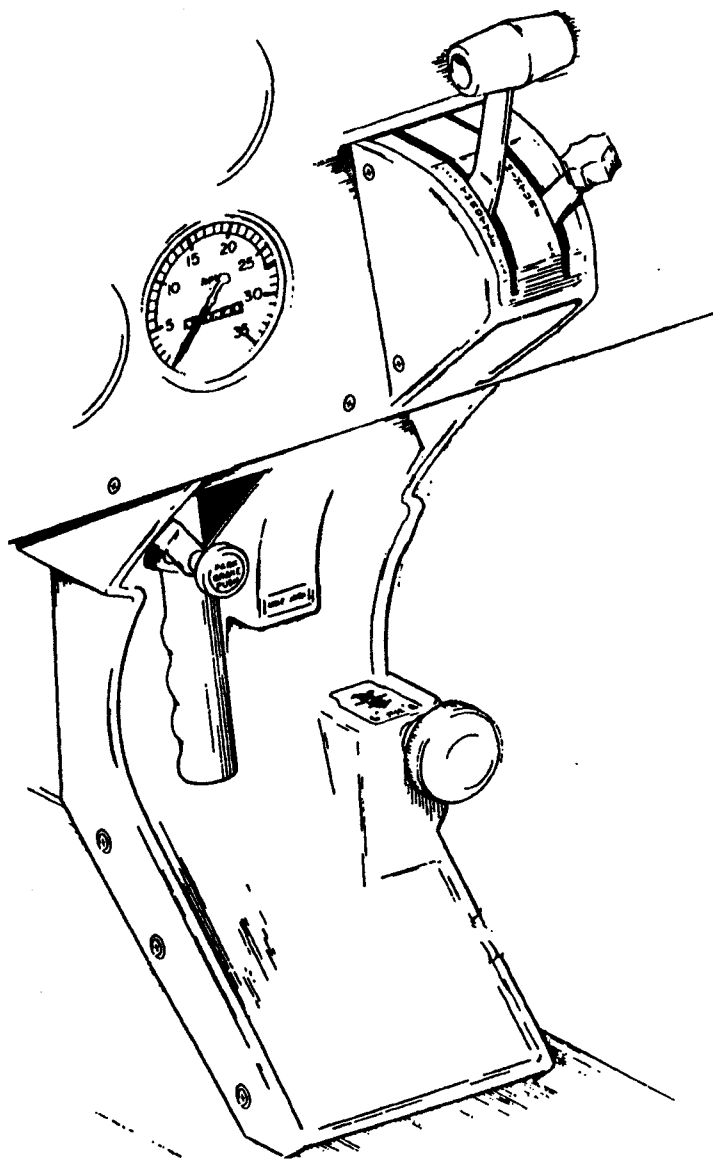

CONTROL QUADRANT AND CONSOLE

Figure 7-5

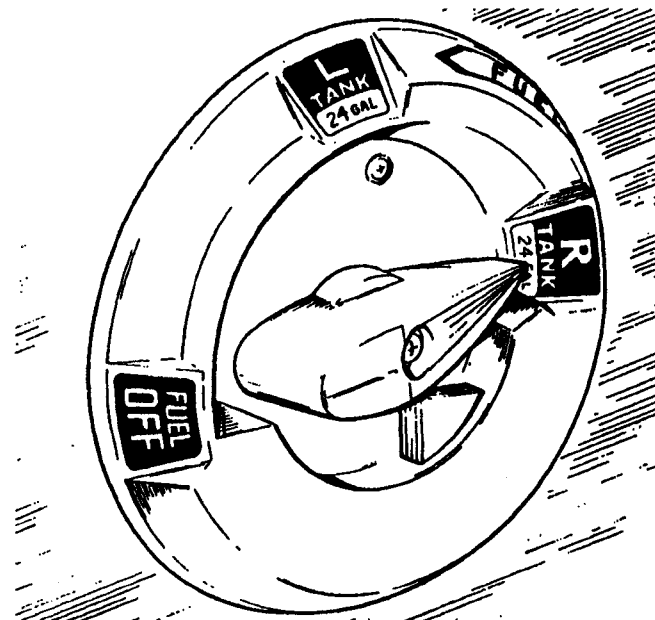

**FUEL SELECTOR**

Figure 7-7

### 7.13 FUEL SYSTEM

Fuel is stored in two twenty-five gallon (24 gallons usable) fuel tanks, giving the airplane a total capacity of fifty U.S. gallons (48 gallons usable). Each tank is equipped with a filler neck indicator tab to aid in determining fuel remaining when the tanks are not full. Usable capacity to the bottom of the indicator tab is 17 gallons. The tanks are secured to the leading edge of each wing with screws and nut plates. This allows removal for service or inspection.

The fuel tank selector control (Figure 7-7) is located on the left side panel forward of the pilot's seat. The button on the selector cover must be depressed and held while the handle is moved to the OFF position. The button releases automatically when the handle is moved back to the ON position.

An auxiliary electric fuel pump is provided in case of the failure of the engine-driven pump. The electric pump should be ON for all takeoffs and landings and when switching tanks. The fuel pump switch is located in the switch panel above the throttle quadrant.

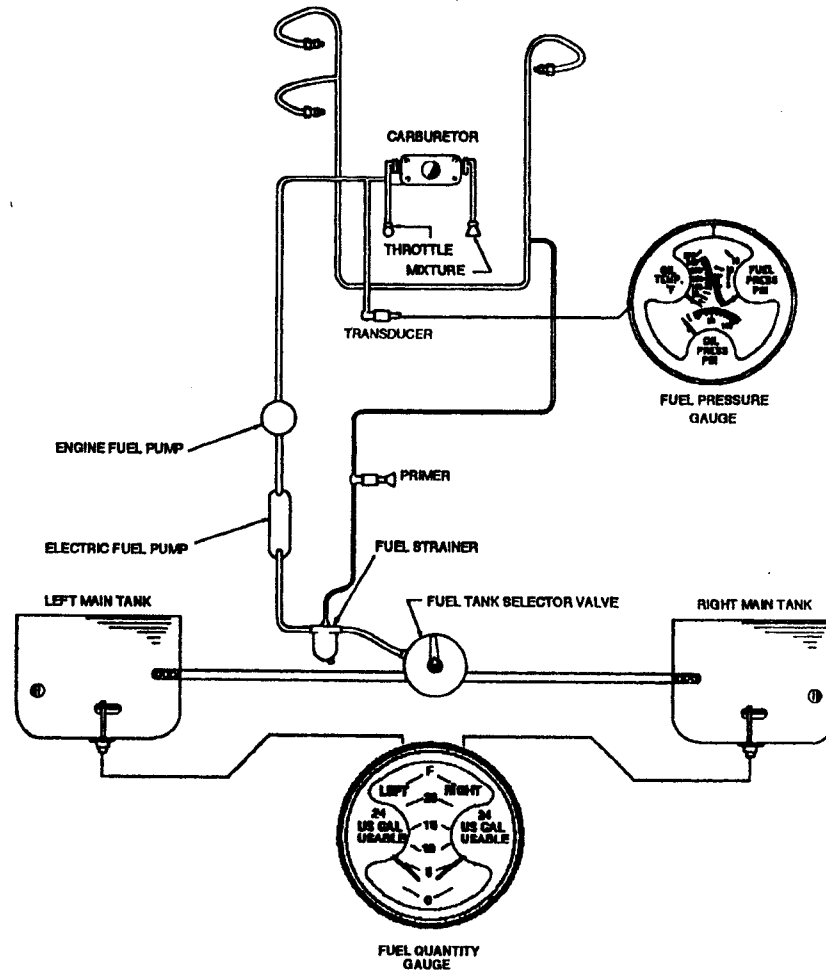

FUEL SYSTEM SCHEMATIC

Figure 7-9

The fuel drains should be opened daily prior to first flight to check for water or sediment and proper fuel. Each tank has an individual drain at the bottom, inboard rear corner. A fuel strainer, located on the lower left front of the fire wall, has a drain which is accessible from outside the nose section. The strainer should also be drained before the first flight of the day. Refer to Section 8 for the complete fuel draining procedure.

Fuel quantity and fuel pressure gauges are combined in a single gauge located on the center of the instrument panel just above the engine tachometer (refer to Figure 7-15).

An electric engine priming system is available to facilitate starting. Pressing the momentary primer switch on, automatically activates the electric fuel pump and opens a solenoid valve, which then supplies fuel to the fuel primer lines.

#### **7.15 ELECTRICAL SYSTEM**

The electrical system includes a 28-volt, 60-amp alternator; a 24-volt battery; a voltage regulator and a master switch relay (Figure 7-11). The battery is in a box, mounted on the forward right face of the fire wall. The regulator and overvoltage relay are located on the forward left side of the fuselage behind the instrument panel.

Electrical switches are located on the right center instrument panel (refer to Figure 7-15), and the circuit breakers are located on the lower right instrument panel (refer to Figure 7-13). Three rheostat switches located on the pilots lower instrument panel controls and dims the switch, panel and avionics lights.

Standard electrical accessories include a starter, electric fuel pump, stall warning indicator, fuel gauge, ammeter, and annunciator panel.



The annunciator panel includes alternator inop., and oil pressure indicator lights. The annunciator panel also includes a vacuum inop. light, low volts and starter engage indicator lights. The annunciator panel lights are provided only as a warning to the pilot that a system may not be operating properly, and that he should check and monitor the applicable system gauge to determine when or if any necessary action is required.

Electrical accessories include navigation lights, wing tip recognition lights, wing tip strobe lights, landing light, instrument lighting, and cabin dome light. Circuits will handle the addition of communications and navigational equipment.

A flood light, mounted in the overhead panel, provides instrument and cockpit lighting for night flying. The light is controlled by a rheostat switch located adjacent to the light. A map light window in the lens is actuated by an adjacent switch.

#### **WARNING**

Anti-collision lights should not be operating when flying through cloud, fog or haze, since the reflected light can produce spatial dis-orientation. Strobe lights should not be used in close proximity to the ground such as during taxiing, takeoff or landing.

Unlike previous generator systems, the ammeter as installed does not show battery discharge; rather, it indicates the electrical load on the alternator in amperes. With all the electrical equipment off and the master switch on, the ammeter will indicate the charging rate of the battery. As each electrical unit is switched on, the ammeter will indicate the total ampere draw of all the units including the battery. For example, the average continuous load for night flight with radios on is about 30 amperes. This 30 ampere value plus approximately 2 amperes for a fully charged battery will appear continuously under these flight conditions. The amount of current shown on the ammeter will tell immediately if the alternator system is operating normally, as the amount of current shown should equal the total amperage drawn by the electrical equipment which is operating.

For abnormal and/or emergency operation and procedures, see Section 3.

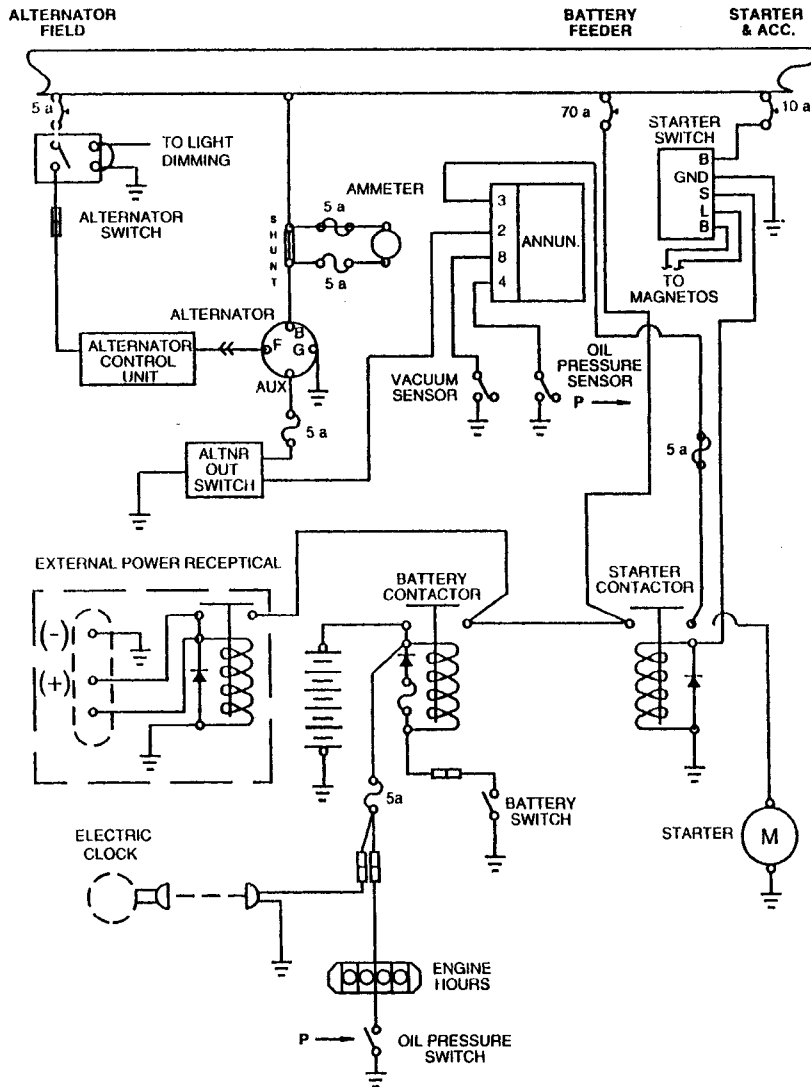

ALTERNATOR AND STARTER SCHEMATIC

Figure 7-11

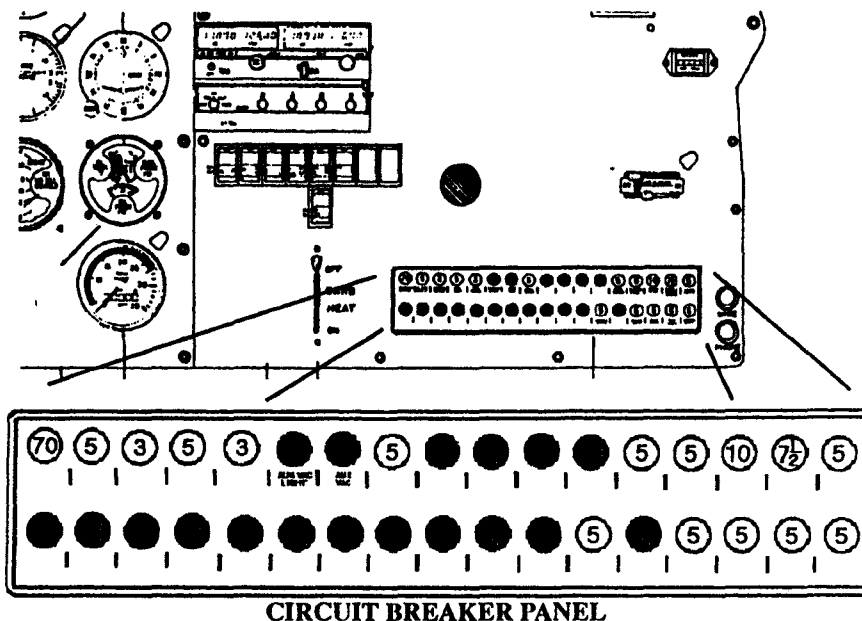

Figure 7-13

**7.17 VACUUM SYSTEM**

The vacuum system is designed to operate the air-driven gyro instruments. This includes the directional and attitude gyros when installed. The system consists of an engine driven vacuum pump, a vacuum regulator, a filter and the necessary plumbing.

The vacuum pump is a dry-type pump. A shear drive protects the pump from damage. If the drive shears, the gyros will become inoperative.

A vacuum gauge, mounted on the far left instrument panel, provides a pilot check for the system during operation. A decrease in pressure in a system that remained constant over an extended period may indicate a dirty filter, dirty screens, possibly a sticky vacuum regulator or leak in the system (a low vacuum indicator light is provided in the annunciator panel). Zero pressure would indicate a sheared pump drive, defective pump, possibly a defective

**SECTION 7**  
**DESCRIPTION & OPERATION**

**PA-28-161, WARRIOR III**

---

gauge or collapsed line. In the event of any gauge variation from the norm, the pilot should have a mechanic check the system to prevent possible damage to the system components or eventual failure of the system.

A vacuum regulator is provided in the system to protect the gyros. The valve is set so the normal vacuum reads 4.8 to 5.2 inches of mercury, a setting which provides sufficient vacuum to operate all the gyros at their rated RPM. Higher settings will damage the gyros and with a low setting the gyros will be unreliable. The regulator is located behind the instrument panel. Vacuum pressure, even though set correctly, can read lower at very high altitude (above 12,000 ft), and at low engine RPM (usually on approach or during training maneuvers). This is normal and should not be considered a malfunction.

**7.19 INSTRUMENT PANEL**

The instrument panel (Figure 7-15) is designed to accommodate instruments and avionics equipment for VFR and IFR flights.

The artificial horizon and directional gyro are vacuum operated and are located in the center of the left hand instrument panel. The vacuum gauge is located on the upper left hand instrument panel. The turn indicator on the left side is electrically operated.

The radios are located in the center section of the panel, and the circuit breakers are in the lower right corner of the panel.

Standard instruments include a compass, an airspeed indicator, a tachometer, altimeter, ammeter, engine cluster gauge, fuel quantity gauge, and an annunciator panel. The compass is mounted on the windshield bow in clear view of the pilot.



1. CLOCK (ELECTRIC) (OPTIONAL)
2. AIRSPEED INDICATOR
3. ATTITUDE GYRO
4. ALTIMETER
5. DAY/NIGHT SWITCH
6. ANNUNCIATOR PANEL
7. COMPASS (MAGNETIC)
- 7a. COMPASS CORRECTION CARD
8. COMM / NAV RADIO
9. TRANSPONDER
10. AMMETER (DIGITAL)
11. HOUR METER
12. TACHOMETER (RPM)
13. FUEL QUANTITY
14. DIRECTIONAL GYRO
15. TURN & BANK
16. VACUUM GAUGE
17. CABIN AIR CONTROL  
WINDSHIELD DEFROST AND HEAT
18. CIRCUIT BREAKER PANEL
19. CARB. HEAT
20. SWITCH PANEL
21. ENGINE GAUGE, OIL TEMP  
OIL AND FUEL PRESSURE, .
22. VOR/LOC NAVIGATION INDICATOR
23. VERTICAL SPEED INDICATOR
24. LIGHT CONTROL AND DIMMING  
SWITCH, INST.PANEL,& RADIOS
25. MAGNETO & START SWITCH
26. MIC/PHONE JACKS
27. ELT CONTROL
28. INTERCOM CONTROL
29. ENGINE PRIMER (ELECTRIC)

TYPICAL INSTRUMENT PANEL

Figure 7-15 (cont)

ISSUED: JULY 12, 1995

REPORT: VB-1610  
7-17

**7.21 PITOT-STATIC SYSTEM**

The system supplies both pitot and static pressure for the airspeed indicator, altimeter, and vertical speed indicator (Figure 7-17).

Pitot and static pressure are picked up by a pitot head installed on the bottom of the left wing and carried through pitot and static lines within the wing and fuselage to the gauges on the instrument panel.

An alternate static source control valve is located below the left side of the instrument panel. When the valve is set in the alternate position, the altimeter, vertical speed indicator and airspeed indicator will be using cabin air for static pressure. The storm window and cabin vents must be closed and the cabin heater and defroster must be on during alternate static source operation. The altimeter error is less than 50 feet unless otherwise placarded.

Both the pitot and static lines can be drained through separate drain valves located on the left lower side of the fuselage interior.

A heated pitot head, which alleviates problems with icing and heavy rain, is available as optional equipment. The switch for the heated pitot head is located on the electrical switch panel to the left of the right control wheel.

A pitot heat inop/off annunciator is provided with the heated pitot head option. The annunciator will be on anytime the pitot heat is turned off or is drawing insufficient current to adequately heat the pitot head.

To prevent bugs and water from entering the pitot and static pressure holes, a cover should be placed over the pitot head. A partially or completely blocked pitot head will give erratic or zero readings on the instruments.

**NOTE**

During the preflight, check to make sure the pitot cover is removed.



**PITOT-STATIC SYSTEM**

Figure 7-17



HEATING AND VENTILATING SYSTEM

Figure 7-19

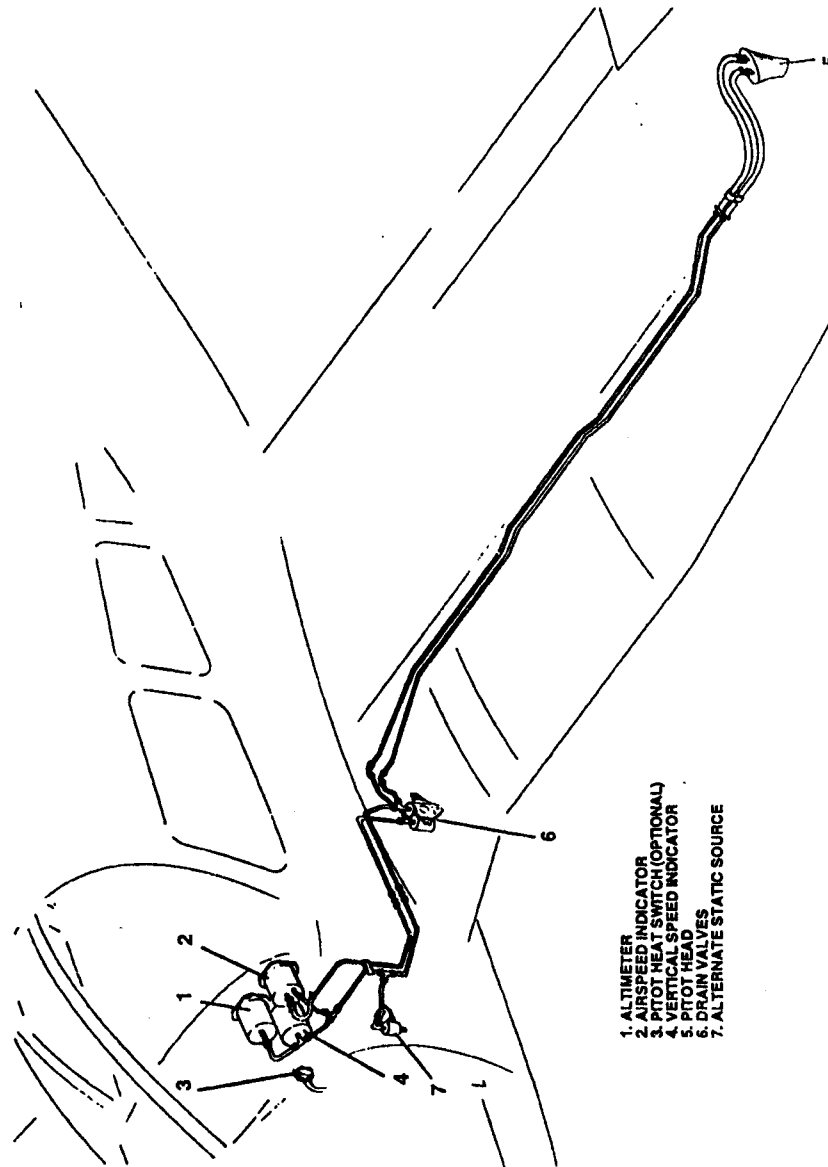
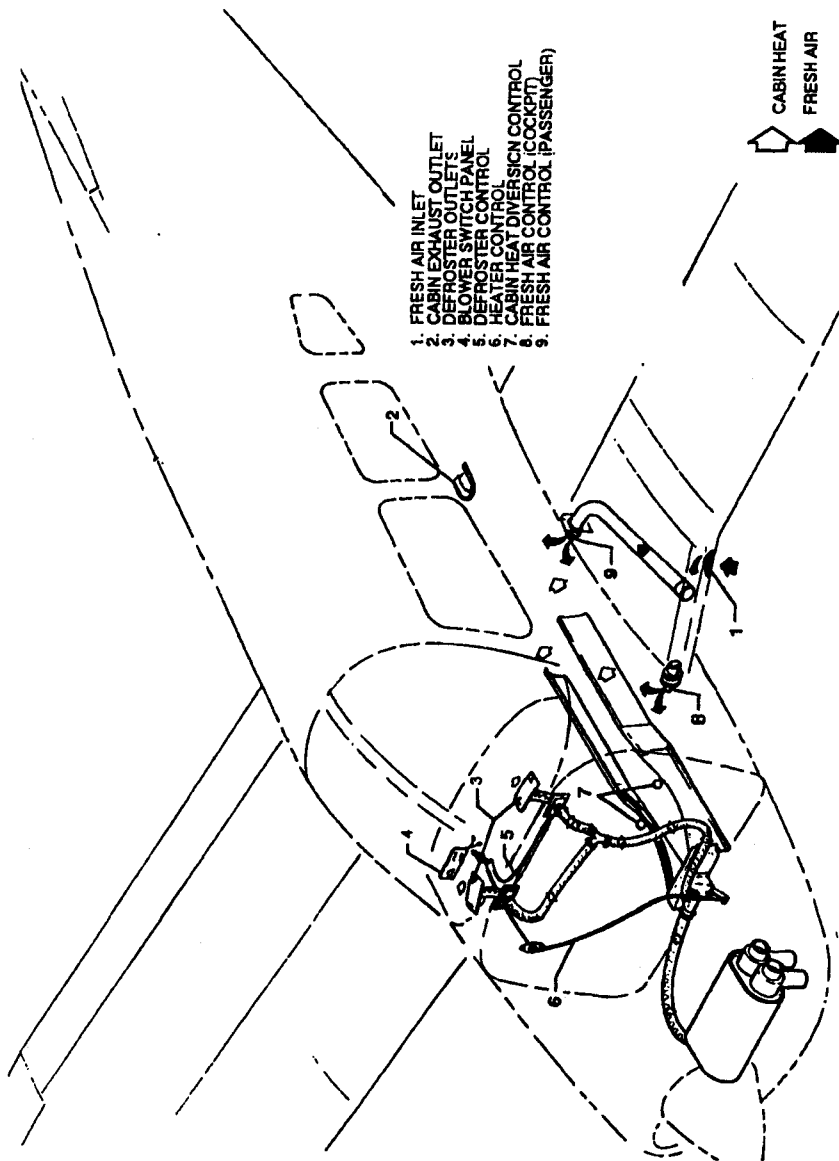
**7.23 HEATING AND VENTILATING SYSTEM**

Heat for the cabin interior and the defroster system is provided by a shroud attached to the muffler (Figure 7-19). The amount of heat can be regulated with the controls located on the far right side of the instrument panel.

The airflow between front and rear seats can be regulated by the heat diversion controls located on either side of the console atop the heat ducts.

**CAUTION**

When cabin heat is operated, heat duct surface becomes hot. This could result in burns if arms or legs are placed too close to heat duct outlets or surface.

Fresh air inlets are located in the leading edges of the wings near the fuselage. At each front seat location there is an adjustable fresh air outlet on the side of the cabin near the floor. Cabin air is exhausted through an outlet located below the rear seat.

An optional overhead ventilating system with outlets over each seat is also available. An additional option to aid in fresh air circulation on models without air conditioning is a cabin air blower to force air through the overhead vent system. This blower is operated by a fan switch with four positions - OFF, LOW, MED, and HIGH. The switch is located on the right side of the instrument panel with the heater and defroster controls.

**7.25 CABIN FEATURES**

For ease of entry and exit and for pilot-passenger comfort, the front seats are adjustable fore and aft. The right front seat tilts forward to allow easy entry to the rear seats. The cabin interior includes a pilot storm window, ash trays and armrests on each front seat, two map pockets and pockets on the backs of the front seats.

The front seats are vertically adjustable.

Shoulder harnesses with inertia reels are provided for each front seat occupant and, depending on the model year, are provided as standard or optional equipment for the occupants of the rear seats. A check of the inertia reel mechanism can be made by pulling sharply on the strap and checking that the reel will lock in place under sudden stress. This locking feature prevents the strap from extending and holds the occupant in place. Under normal movement the strap will extend and retract as required. Shoulder harnesses should be routinely worn during takeoff, landing and whenever an inflight emergency situation occurs.

#### **7.27 BAGGAGE AREA**

A 24 cubic foot baggage area, located behind the rear seat, is accessible from the cabin or loaded through a large 20 x 22 inch outside baggage door on the right side of the fuselage. Maximum capacity is 200 pounds. Tie-down straps are available and they should be used at all times.

#### **NOTE**

It is the pilot's responsibility to be sure when the baggage is loaded that the aircraft C.G. falls within the allowable C.G. range. (See Weight and Balance Section.)

#### **7.29 STALL WARNING**

An approaching stall is indicated by an audible alarm located behind the instrument panel. The indicator activates at between five and ten knots above stall speed.

#### **7.31 FINISH**

All exterior surfaces are primed with etching primer and finished with acrylic lacquer. To keep the finish attractive, economy size spray cans of touch-up paint are available from Piper Dealers.

**7.33 PIPER EXTERNAL POWER**

A external power receptacle is accessible through a receptacle cover door located on the right rear side of the fuselage, aft of the wing. An external battery can be connected to the socket, thus allowing the operator to crank the engine without having to gain access to the airplane's battery. Instructions on a placard located on the cover door of the receptacle should be followed before using the external power.

**7.35 EMERGENCY LOCATOR TRANSMITTER\***

The Emergency Locator Transmitter (ELT) is located in the aft portion of the fuselage just below the stabilator leading edge and is accessible through a plate on the right side of the fuselage. This plate is attached with slotted-head nylon screws for ease of removal; these screws may be readily removed with a variety of common items such as a dime, a key, a knife blade, etc. If there are no tools available in an emergency, the screw heads may be broken off by any means.

A battery replacement date is marked on the transmitter to comply with FAA regulations, the battery must be replaced on or before this date. The battery must also be replaced if the transmitter has been used in an emergency situation or, if the accumulated test time exceeds one hour, or if the unit has been inadvertently activated for an undetermined time period.

**NOTE:**

If for any reason a test transmission is necessary, the test transmission should be conducted only in the first five minutes of any hour and limited to three audio sweeps. If the tests must be made at any other time, the tests should be coordinated with the nearest FAA tower or flight service station.

**ARTEX ELT OPERATION**

On the ELT unit itself is a two position switch placarded ON and OFF. The OFF position is selected when the transmitter is installed at the factory and the switch should remain in that position whenever the unit is installed in the airplane.

**ARTEX ELT OPERATION (continued)**

A pilots remote switch, placarded ON and ARM is located on the left hand side of the pilot's instrument panel to allow the transmitter to be armed or turned on from inside the cabin. The switch is normally in ARM position. Moving the switch to ON will activate the transmitter. A warning light located above the remote switch will alert you when ever the ELT is activated.

The ME-406 ELT (406MHz), if installed, is equipped with a warning buzzer. This warning buzzer, which receives power from the ELT itself, is mounted in the tailcone. Whenever the ELT is activated the buzzer "beeps" periodically. The time between pluses lengthens after a predetermined transmitter "ON" time. The objective is to hear the buzzer from outside the aircraft while the engine is not running.

Should the ELT be activated inadvertently it can be reset by either positioning the remote switch to the ON then immediately relocating it to the ARM position, or by setting the switch on the ELT to ON and then back to OFF.

In the event the transmitter is activated by an impact, it can be turned off by moving the ELT switch OFF. Normal operation can then be restored by resetting the switch to ARM. It may also be turned off and reset by positioning the remote switch to the ON and then immediately to the ARM position.

The transmitter can be activated manually at any time by placing either the remote switch or the ELT switch to the ON position.

**NOTE:**

Three sweeps of the emergency tone and an illuminated warning light indicates a normally functioning unit. The warning light must illuminate during the first 3 second test period. If it does not illuminate, a problem is indicated such as a "G" switch failure.

The ELT should be checked during postflight to make certain the unit has not been activated. Check by selecting 121.50 MHz on an operating receiver. If a downward sweeping audio tone is heard the ELT may have been activated. Set the remote switch to ON. If there is no change in the volume of the signal, your airplane's ELT is probably transmitting. Setting the remote switch back to OFF will automatically reset the ELT and should stop the signal being received on 121.50 MHz.

**TABLE OF CONTENTS**  
**SECTION 8**  
**AIRPLANE HANDLING, SERVICING AND MAINTENANCE**

Paragraph No.		Page No.
8.1	General .....	8-1
8.3	Airplane Inspection Periods .....	8-2
8.5	Preventive Maintenance .....	8-3
8.7	Airplane Alterations .....	8-4
8.9	Ground Handling.....	8-5
8.11	Engine Air Filter.....	8-7
8.13	Brake Service .....	8-8
8.15	Landing Gear Service.....	8-9
8.17	Propeller Service .....	8-11
8.19	Oil Requirements.....	8-12
8.21	Fuel System .....	8-12
8.23	Tire Inflation.....	8-15
8.25	Battery Service .....	8-16
8.27	Cleaning .....	8-16
8.29	Cold Weather Operation.....	8-19

**THIS PAGE INTENTIONALLY LEFT BLANK**



**SECTION 8**

**AIRPLANE HANDLING, SERVICING AND MAINTENANCE**

**8.1 GENERAL**

This section provides general guidelines relating to the handling, servicing, and maintenance of the WARRIOR III. For complete maintenance instructions, refer to the PA-28-161 Maintenance Manual.

Every owner should stay in close contact with an authorized Piper Service Center or Piper's Customer Service Department to obtain the latest information pertaining to his aircraft and to avail himself of Piper's support systems.

Piper takes a continuing interest in having the owner get the most efficient use from his aircraft and keeping it in the best mechanical condition. Consequently, Piper, from time to time, issues Service Bulletins, Service Letters, Service Spares Letters, and others relating to the airplane.

Service Bulletins are of special importance and Piper considers compliance mandatory. These are sent directly to the latest FAA-registered owners in the United States (U.S.) and Piper Service Centers worldwide. Depending on the nature of the release, material and labor allowances may apply. This information is provided to all authorized Service Centers.

Service Letters deal with product improvements and servicing techniques pertaining to the airplane. They are sent to Piper Service Centers and, if necessary, to the latest FAA-registered owners in the U.S. Owners should give careful attention to Service Letter information.

Service Spares Letters offer improved parts, kits, and optional equipment which were not available originally, and which may be of interest to the owner.

Piper offers a subscription service for the Service Bulletins, Service Letters, and Service Spares Letters. This service is available to interested persons such as owners, pilots, and mechanics at a nominal fee, and may be obtained through an authorized Piper Service Center or Piper's Customer Services Department.

Maintenance manuals, parts catalogs, and revisions to both, are available from Piper Service Centers or Piper's Customer Services Department.

Any correspondence regarding the airplane should include the airplane model and serial number to ensure proper response.

### **8.3 AIRPLANE INSPECTION PERIODS**

Piper has developed inspection items and required inspection intervals for the PA-28-161 (see the latest revision of the PA-28-161 Maintenance and Inspection Manuals). The PA-28-161 Inspection Manual contains appropriate forms, and all inspection procedures should be complied with by a properly trained, knowledgeable, and qualified mechanic at a Piper Authorized Service Center or a reputable repair shop. Piper cannot accept responsibility for the continued airworthiness of any aircraft not maintained to these standards, and/or not brought into compliance with applicable Service Bulletins issued by Piper, instructions issued by the engine, propeller, or accessory manufacturers, or Airworthiness Directives issued by the FAA.

A programmed inspection, approved by the FAA, is also available to the owner. This involves routine and detailed inspections to allow maximum utilization of the airplane. Maintenance inspection costs are reduced and the maximum standard of continued airworthiness is maintained. Complete details are available from Piper.

In addition, but in conjunction with the above, the FAA requires periodic inspections on all aircraft to keep the Airworthiness Certificate in effect. The owner is responsible for assuring compliance with these inspection requirements and for maintaining proper documentation in logbooks and/or maintenance records.

**8.1 GENERAL (CONTINUED)**

Every owner should stay in close contact with an authorized Piper Service Center or Piper's Customer Services Department to obtain the latest information pertaining to their airplane, and to avail themselves of Piper's support systems.

Piper takes a continuing interest in having owners get the most efficient use from their airplane and keeping it in the best mechanical condition. Consequently, Piper, from time to time, issues service releases including Service Bulletins, Service Letters, Service Spares Letters, and others relating to the airplane.

Piper Service Bulletins are of special importance and Piper considers compliance mandatory. These are available on the Piper.com website. Depending on the nature of the release, material and labor allowances may apply. This information is provided to all authorized Piper Service Centers.

Service Letters deal with product improvements and servicing techniques pertaining to the airplane. They are available on the Piper.com website. Owners should give careful attention to Service Letter information.

Service Spares Letters offer improved parts, kits, and optional equipment which were not available originally, and which may be of interest to the owner.

Maintenance manuals, parts catalogs, and revisions to both, are available from Piper Service Centers.

Any correspondence regarding the airplane should include the airplane model and serial number to ensure proper response.

### 8.3 AIRPLANE INSPECTION PERIODS

#### *WARNING*

All inspection intervals, replacement time limits, overhaul time limits, the method of inspection, life limits, cycle limits, etc., recommended by PIPER are solely based on the use of new, remanufactured or overhauled PIPER approved parts. If parts are designed, manufactured, remanufactured, overhauled and/or approved by entities other than PIPER, then the data in PIPER'S maintenance/service manuals and parts catalogs are no longer applicable and the purchaser is warned not to rely on such data for non-PIPER parts. All inspection intervals, replacement time limits, overhaul time limits, the method of inspection, life limits, cycle limits, etc., for such non-PIPER parts must be obtained from the manufacturer and/or seller of such non-PIPER parts.

Piper has developed inspection items and required inspection intervals for the PA-28-161 (see the latest revision of the PA-28-161 Maintenance and Inspection Manuals). The PA-28-161 Inspection Manual contains appropriate forms, and all inspection procedures should be complied with by a properly trained, knowledgeable, and qualified mechanic at a Piper Authorized Service Center or a reputable repair shop. Piper cannot accept responsibility for the continued airworthiness of any aircraft not maintained to these standards, and/or not brought into compliance with applicable Service Bulletins issued by Piper, instructions issued by the engine, propeller, or accessory manufacturers, or Airworthiness Directives issued by the FAA.

A programmed Inspection, approved by the Federal Aviation Administration (FAA), is also available to the owner. This involves routine and detailed inspections to allow maximum utilization of the airplane. Maintenance inspection costs are reduced, and the maximum standard of continued airworthiness is maintained. Complete details are available from Piper.

In addition, but in conjunction with the above, the FAA requires periodic inspections on all aircraft to keep the Airworthiness Certificate in effect. The owner is responsible for assuring compliance with these inspection requirements and for maintaining proper documentation in logbooks and/or maintenance records.

A spectographic analysis of the engine oil is available from several sources. This inspection, if performed properly, provides a good check of the internal condition of the engine. To be accurate, induction air filters must be cleaned or changed regularly, and oil samples must be taken and sent in at regular intervals.

### **8.5 PREVENTIVE MAINTENANCE**

The holder of a pilot certificate issued under Federal Aviation Regulations (FAR) Part 61 may perform certain preventive maintenance as defined in the FARs. This maintenance may be performed only on an aircraft which the pilot owns and operates, and which is not used in air carrier or air taxi/commercial operations service.

All other aircraft maintenance must be accomplished by a person or facility appropriately certificated by the Federal Aviation Administration (FAA) to perform that work.

Anytime maintenance is accomplished, an entry must be made in the appropriate aircraft maintenance records. The entry shall include:

- (a) The date the work was accomplished.
- (b) Description of the work.
- (c) Number of hours on the aircraft.
- (d) The certificate number of pilot performing the work.
- (e) Signature of the individual doing the work.

### **8.7 AIRPLANE ALTERATIONS**

If the owner desires to have his aircraft modified, he must obtain FAA approval for the alteration. Major alterations accomplished in accordance with Advisory Circular 43.13-2, when performed by an A & P mechanic, may be approved by the local FAA office. Major alterations to the basic airframe or systems not covered by AC 43.13-2 require a Supplemental Type Certificate.

The owner or pilot is required to ascertain that the following Aircraft Papers are in order and in the aircraft.

- (a) To be displayed in the aircraft at all times:
  - (1) Aircraft Airworthiness Certificate Form FAA-8100-2.
  - (2) Aircraft Registration Certificate Form FAA-8050-3.
  - (3) Aircraft Radio Station License if transmitters are installed.
  
- (b) To be carried in the aircraft at all times:
  - (1) Pilot's Operating Handbook.
  - (2) Weight and Balance data plus a copy of the latest Repair and Alteration Form FAA-337, if applicable.
  - (3) Aircraft equipment list.

Although the aircraft and engine logbooks are not required to be in the aircraft, they should be made available upon request. Logbooks should be complete and up to date. Good records will reduce maintenance cost by giving the mechanic information about what has or has not been accomplished.

**8.9 GROUND HANDLING****(a) Towing**

The airplane may be moved on the ground by the use of the nose wheel steering bar that is stowed below the forward ledge of the baggage compartment or by power equipment that will not damage or excessively strain the nose gear steering assembly. Towing lugs are incorporated as part of the nose gear fork.

**CAUTIONS**

When towing with power equipment, do not turn the nose gear beyond its steering radius in either direction, as this will result in damage to the nose gear and steering mechanism.

Do not tow the airplane when the controls are secured.

In the event towing lines are necessary, ropes should be attached to both main gear struts as high up on the tubes as possible. Lines should be long enough to clear the nose and/or tail by not less than fifteen feet, and a qualified person should ride in the pilot's seat to maintain control by use of the brakes.

**(b) Taxiing**

Before attempting to taxi the airplane, ground personnel should be instructed and approved by a qualified person authorized by the owner. Engine starting and shut-down procedures as well as taxi techniques should be covered. When it is ascertained that the propeller back blast and taxi areas are clear, power should be applied to start the taxi roll, and the following checks should be performed:

- (1) Taxi a few feet forward and apply the brakes to determine their effectiveness.
- (2) While taxiing, make slight turns to ascertain the effectiveness of the steering.
- (3) Observe wing clearance when taxiing near buildings or other stationary objects. If possible, station an observer outside the airplane.

- (4) When taxiing over uneven ground, avoid holes and ruts.
- (5) Do not operate the engine at high RPM when running up or taxiing over ground containing loose stones, gravel, or any loose material that may cause damage to the propeller blades.

(c) **Parking**

When parking the airplane, be sure that it is sufficiently protected from adverse weather conditions and that it presents no danger to other aircraft. When parking the airplane for any length of time or overnight, it is suggested that it be moored securely.

- (1) To park the airplane, head it into the wind if possible.
- (2) Set the parking brake by pulling back on the brake lever and depressing the knob on the handle. To release the parking brake, pull back on the handle until the catch disengages; then allow the handle to swing forward.

**CAUTION**

Care should be taken when setting brakes that are overheated or during cold weather when accumulated moisture may freeze a brake.

- (3) Aileron and stabilator controls should be secured with the front seat belt and chocks used to properly block the wheels.

(d) **Mooring**

The airplane should be moored for immovability, security and protection. The following procedures should be used for the proper mooring of the airplane:

- (1) Head the airplane into the wind if possible.
- (2) Retract the flaps.
- (3) Immobilize the ailerons and stabilator by looping the seat belt through the control wheel and pulling it snug.
- (4) Block the wheels.



- (5) Secure tie-down ropes to the wing tie-down rings and to the tail skid at approximately 45-degree angles to the ground. When using rope of non-synthetic material, leave sufficient slack to avoid damage to the airplane should the ropes contract.

**CAUTION**

Use bowline knots, square knots or locked slip knots. Do not use plain slip knots.

**NOTE**

Additional preparations for high winds include using tie-down ropes from the landing gear forks and securing the rudder.

- (6) Install a pitot head cover if available. Be sure to remove the pitot head cover before flight.
- (7) Cabin and baggage doors should be locked when the airplane is unattended.

**8.11 ENGINE AIR FILTER**

The wet-type polyurethane foam air filter must be inspected at least once every fifty hours. Under extremely adverse operating conditions, it may be necessary to inspect the filter more frequently. The filter is disposable and inexpensive and a spare should be kept on hand for a rapid replacement.

**(a) Removal Of Engine Air Filter**

The filter is located in the lower right front of the engine compartment and may be removed by the following procedure:

- (1) Open the right side of the engine cowling.
- (2) Loosen each of the four quarter-turn fasteners securing the air filter cover.
- (3) Separate the cover and remove the filter.
- (4) Inspect the filter. If it is excessively dirty or shows any damage, replace it immediately.

**(b) Cleaning Engine Air Filter**

The induction air filter must be cleaned at least once every 50 hours, and more often, even daily, when operating in dusty conditions. Extra filters are inexpensive, and a spare should be kept on hand for use as a rapid replacement.

To clean the filter:

- (1) Tap the filter gently to remove dirt particles, being careful not to damage the filter. DO NOT wash the filter in any liquid. DO NOT attempt to blow out dirt with compressed air.
- (2) If the filter is excessively dirty or shows any damage, replace it immediately.
- (3) Wipe the filter housing with a clean cloth soaked in unleaded gasoline. When the filter housing is clean and dry, install the filter.

**(c) Installation Of Engine Air Filter**

When replacing the filter, install the filter in the reverse order of removal.

**8.13 BRAKE SERVICE**

The brake system is filled with MIL-H-5606 (petroleum base) hydraulic brake fluid. The fluid level should be checked periodically or at every 50-hour inspection and replenished when necessary. The brake reservoir is located on the fire wall in the engine compartment. If the entire system must be refilled, fill with fluid under pressure from the brake end of the system. This will eliminate air from the system.

No adjustment of the brake clearances is necessary. If after extended service brake blocks become excessively worn, they should be replaced with new segments.

**8.15 LANDING GEAR SERVICE**

The main landing gears use 6.00 x 6 wheels and the nose gear carries a 5.00 x 5 wheel. All three tires are four-ply rating, type III tires with tubes. (Refer to paragraph 8.23).

Wheels are removed by taking off the hub cap, cotter pin, axle nut, and the two bolts holding the brake segment in place. Mark tire and wheel for reinstallation; then dismount by deflating the tire, removing the three through-bolts from the wheel and separating the wheel halves.

Landing gear oleos should be serviced according to the instructions on the units. The main oleos should be extended under normal static load until  $4.50 \pm .25$  inches of oleo piston tube is exposed, and the nose gear should show  $3.25 \pm .25$  inches. Should the strut exposure be below that required, it should be determined whether air or oil is required by first raising the airplane on jacks. Depress the valve core to allow air to escape from the strut housing chamber. Remove the filler plug and slowly raise the strut to full compression. If the strut has sufficient fluid, it will be visible up to the bottom of the filler plug hole and will then require only proper inflation.

Should hydraulic fluid be below the bottom of the filler plug hole, fluid should be added. Replace the plug with valve core removed; attach a clear plastic hose to the valve stem of the filler plug and submerge the other end in a container of hydraulic fluid. Fully compress and extend the strut several times, thus drawing fluid from the container and expelling air from the strut chamber. To allow fluid to enter the bottom chamber of the main gear strut housing, the torque link assembly must be disconnected to let the strut be extended a minimum of 10 inches (the nose gear torque links need not be disconnected). Do not allow the strut to extend more than 12 inches. When air bubbles cease to flow through the hose, compress the strut fully and again check fluid level. Reinstall the valve core and filler plug, and the main gear torque links, if disconnected.

With fluid in the strut housing at the correct level, attach a strut pump to the air valve and with the airplane on the ground, inflate the oleo strut to the correct height.

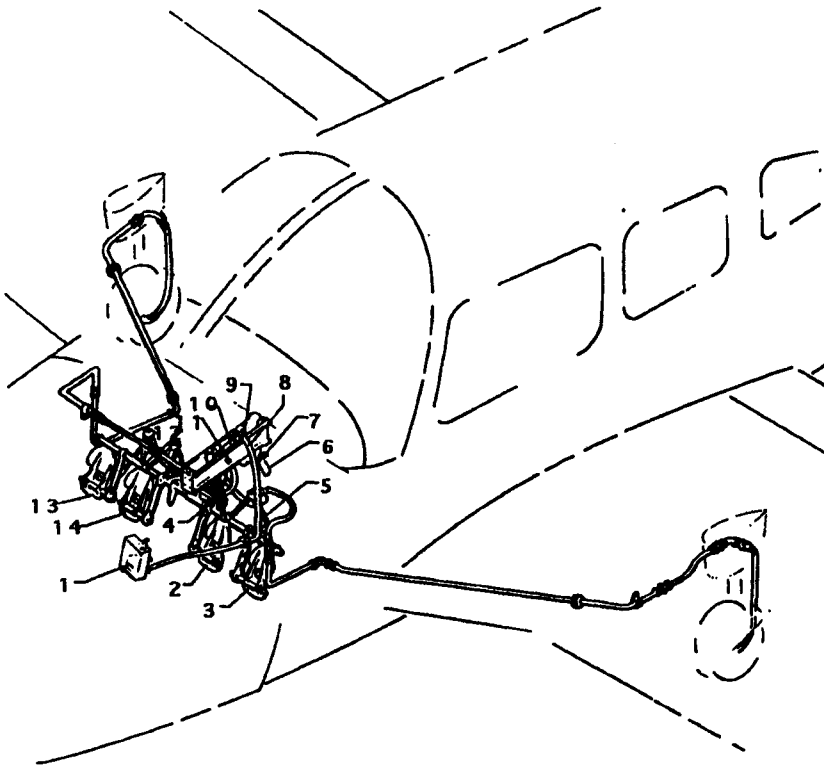

1. BRAKE RESERVOIR
2. RIGHT BRAKE AND RUDDER PEDAL
3. LEFT BRAKE AND RUDDER PEDAL
4. RIGHT BRAKE CYLINDER
5. LEFT BRAKE CYLINDER
6. BRAKE HANDLE
7. HANDLE RELEASE BUTTON
8. LINE, INLET
9. CLEVIS PIN
10. MASTER CYLINDER ASSEMBLY
11. BOLT ASSEMBLY
12. TORQUE TUBE
13. COPILOT'S RIGHT BRAKE AND RUDDER PEDAL
14. COPILOT'S LEFT BRAKE AND RUDDER PEDAL

**BRAKE SYSTEM**

Figure 8-1

In jacking the aircraft for landing gear or other service, two hydraulic jacks and a tail stand should be used. At least 250 pounds of ballast should be placed on the base of the tail stand before the airplane is jacked up. The hydraulic jacks should be placed under the jack points on the bottom of the wing and the airplane jacked up until the tail skid is at the right height to attach the tail stand. After the tail stand is attached and the ballast added, jacking may be continued until the airplane is at the height desired.

**8.17 PROPELLER SERVICE**

The spinner and backing plate should be frequently cleaned and inspected for cracks. Before each flight the propeller should be inspected for nicks, scratches, and corrosion. If found, they should be repaired as soon as possible by a rated mechanic, since a nick or scratch causes an area of increased stress which can lead to serious cracks or the loss of a propeller tip. The back face of the blades should be painted when necessary with flat black paint to retard glare. To prevent corrosion, the surface should be cleaned and waxed periodically.

**8.19 OIL REQUIREMENTS**

The oil capacity of the engine is 8 quarts, and the minimum safe quantity is 2 quarts. It is recommended that the oil be drained and renewed every 50 hours and sooner under unfavorable operating conditions. Full flow cartridge type oil filters should be replaced each 50 hours of operation. The interval between oil and oil filter change is not to exceed four (4) months. The following grades are recommended for the specified temperatures:

<u>Average Ambient Temperature</u>	<u>MIL-L-6082B SAE Grade</u>	<u>MIL-L-22851 Ashless Dispersant SAE Grades</u>
All Temperatures	--	15W-50 or 20W-50
Above 80°F	60	60
Above 60°F	50	40 or 50
30°F to 90°F	40	40
0°F to 70°F	30	30, 40 or 20W-40
Below 10°F	20	30 or 20W-30

When operating temperatures overlap indicated ranges, use the lighter grade oil.

**NOTE**

Refer to the latest issue of Lycoming Service Instruction 1014 (Lubricating Oil Recommendations) for further information.

**8.21 FUEL SYSTEM**

(a) Servicing Fuel System

At every 50-hour inspection, the fuel screens in the strainer, in the electric fuel pump, and at the carburetor inlet must be cleaned.

(b) Fuel Requirements (AVGAS ONLY)

The minimum aviation grade fuel for the PA-28-161 is 100. Since the use of lower grades can cause serious engine damage in a short period of time, the engine warranty is invalidated by the use of lower octanes.

Whenever 100 or 100LL grade fuel is not available, commercial grade 100/130 should be used. (See Fuel Grade Comparison Chart). Refer to the latest issue of Lycoming Service Instruction No. 1070 for additional information.

A summary of the current grades as well as the previous fuel designations is shown in the following chart:

**FUEL GRADE COMPARISON CHART**

Previous Commercial Fuel Grades (ASTM-D910)			Current Commercial Fuel Grades (ASTM-D910-75)			Current Military Fuel Grades (MIL-G-5572F)		
Grade	Color	Max. TEL ml/U.S. gal	Grade	Color	Max. TEL ml/U.S. gal	Grade	Color	Max. TEL ml/U.S. gal
80/87	red	0.5	80	red	0.5	80/87	red	0.5
91/96	blue	2.0	*100LL	blue	2.0	none	none	none
100/130	green	3.0	100	green	**3.0	100/130	blue	2.0
115/145	purple	4.6	none	none	none	115/145	purple	4.6

\* -Grade 100LL fuel in some overseas countries is currently colored green and designated as "100L".

\*\* -Commercial fuel grade 100 and grade 100/130 having TEL content of up to 4 ml/U.S. gallon are approved for use in all engines certificated for use with grade 100/130 fuel.

The operation of the aircraft is approved with an anti-icing additive in the fuel. When anti-icing additive is used, it must meet the specification MIL-I-27686, must be uniformly blended with the fuel while refueling, must not exceed .15% by volume of the refueled quantity, and to ensure its effectiveness should be blended at not less than .10% by volume. One and one half liquid ozs. per ten gallons of fuel would fall within this range. A blender supplied by the additive manufacturer should be used. Except for the information contained in this section, the manufacturer's mixing or blending instructions should be carefully followed.

#### **CAUTIONS**

Assure that the additive is directed into the flowing fuel stream. The additive flow should start after and stop before the fuel flow. Do not permit the concentrated additive to come in contact with the aircraft painted surfaces or the interior surfaces of the tanks.

Some fuels have anti-icing additives pre-blended in the fuel at the refinery, so no further blending should be performed.

Fuel additive cannot be used as a substitute for preflight draining of the fuel system drains.

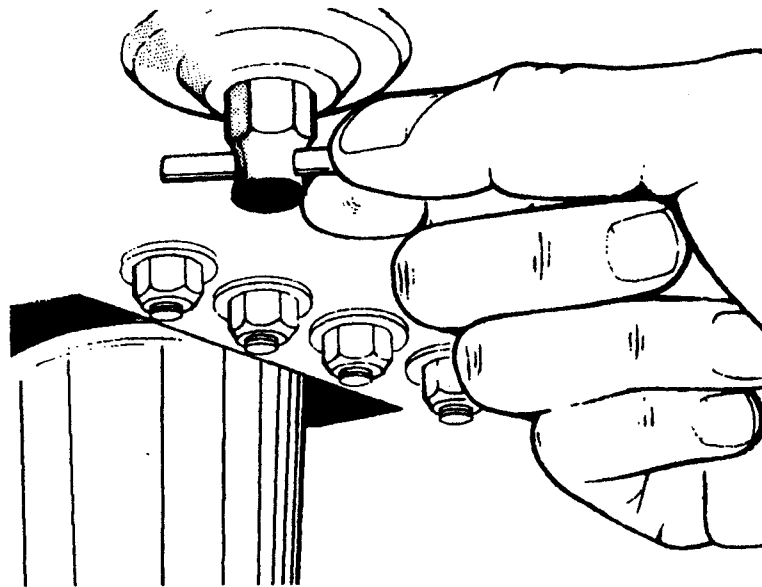

**FUEL DRAIN**  
Figure 8-3

(c) Filling Fuel Tanks

Observe all required precautions for handling gasoline. Fill the fuel tanks through the filler located on the forward slope of the wing. Each wing holds a maximum of 25 U.S. Gallons. When using less than the standard 50 gallon capacity, fuel should be distributed equally between each tank. there is approximately 17 gallons in the fuel tank when fuel level is even with bottom of filler neck indicator.

(d) Draining Fuel Strainer, Sumps and Lines

The fuel tank sumps and strainer should be drained daily prior to the first flight and after refueling to avoid the accumulation of contaminant's such as water or sediment and for proper fuel.



Each fuel tank is equipped with an individual quick drain located at the lower inboard rear corner of the tank. The fuel strainer is equipped with a quick drain located on the front lower corner of the fire wall. Each of the fuel tank sumps should be drained first. Then the fuel strainer should be drained twice, once with the fuel selector valve on each tank. Each time fuel is drained, sufficient fuel should be allowed to flow to ensure removal of contaminants. This fuel should be collected in a suitable container, examined for contaminants, proper fuel and then discarded.

**CAUTIONS**

When draining any amount of fuel, care should be taken to ensure that no fire hazard exists before starting the engine.

After draining, each quick drain should be checked to make sure it has closed completely and is not leaking.

**(e) Draining Fuel System**

The bulk of the fuel may be drained from the system by opening valve at the inboard end of each fuel tank. Push up on the arms of the drain valve and turn counterclockwise to hold the drain open. The remaining fuel in the system may be drained through the filter bowl. Any individual tank may be drained by closing the selector valve and then draining the desired tank.

**8.23 TIRE INFLATION**

For maximum service from the tires, keep them inflated to the proper pressures - 30 psi for the nose gear and 24 psi for the main gear. All wheels and tires are balanced before original installation, and the relationship of tire, tube and wheel should be maintained upon reinstallation. Unbalanced wheels can cause extreme vibration in the landing gear; therefore, in the installation of new components, it may be necessary to rebalance the wheels with the tires mounted. When checking tire pressure, examine the tires for wear, cuts, bruises, and slippage.

### **8.25 BATTERY SERVICE**

Access to the 24-volt battery is obtained by raising upper right cowl which provides access to the battery box, which is mounted on the forward right face of the fire wall. The sealed battery box has a leak proof vent system with a vent tube which vents gases and acid fumes from the battery manifold.

The battery should be checked for proper fluid level. DO NOT fill the battery above the baffle plates. DO NOT fill the battery with acid - use only water. A hydrometer check will determine the percent of charge in the battery.

If the battery is not up to charge, recharge starting at a 4 amp rate and finishing with a 2 amp rate. Quick charges are not recommended.

### **8.27 CLEANING**

#### **(a) Cleaning Engine Compartment**

Before cleaning the engine compartment, place a strip of tape on the magneto vents to prevent any solvent from entering these units.

- (1) Place a large pan under the engine to catch waste.
- (2) With the engine cowling removed, spray or brush the engine with solvent or a mixture of solvent and degreaser. In order to remove especially heavy dirt and grease deposits, it may be necessary to brush areas that were sprayed.

#### **CAUTION**

Do not spray solvent into the alternator, vacuum pump, starter, or air intakes.

- (3) Allow the solvent to remain on the engine from five to ten minutes. Then rinse the engine clean with additional solvent and allow it to dry.

#### **CAUTION**

Do not operate the engine until excess solvent has evaporated or otherwise been removed.

- (4) Remove the protective tape from the magnetos.
- (5) Lubricate the controls, bearing surfaces, etc., in accordance with the Lubrication Chart in the PA-28-161 Service Manual.

(b) **Cleaning Landing Gear**

Before cleaning the landing gear, place a plastic cover or similar material over the wheel and brake assembly.

- (1) Place a pan under the gear to catch waste.
- (2) Spray or brush the gear area with solvent or a mixture of solvent and degreaser, as desired. Where heavy grease and dirt deposits have collected, it may be necessary to brush areas that were sprayed, in order to clean them.
- (3) Allow the solvent to remain on the gear from five to ten minutes. Then rinse the gear with additional solvent and allow to dry.
- (4) Remove the cover from the wheel and remove the catch pan.
- (5) Lubricate the gear in accordance with the Lubrication Chart in the PA-28-161 Service Manual.

(c) **Cleaning Exterior Surfaces**

The airplane should be washed with a mild soap and water. Harsh abrasives or alkaline soaps or detergents could make scratches on painted or plastic surfaces or could cause corrosion of metal. Cover areas where cleaning solution could cause damage. To wash the airplane, use the following procedure:

- (1) Flush away loose dirt with water.
- (2) Apply cleaning solution with a soft cloth, a sponge or a soft bristle brush.
- (3) To remove exhaust stains, allow the solution to remain on the surface longer.
- (4) To remove stubborn oil and grease, use a cloth dampened with naphtha.
- (5) Rinse all surfaces thoroughly.
- (6) Any good automotive wax may be used to preserve painted surfaces. Soft cleaning cloths or a chamois should be used to prevent scratches when cleaning or polishing. A heavier coating of wax on the leading surfaces will reduce the abrasion problems in these areas.

(d) Cleaning Windshield and Windows

- (1) Remove dirt, mud and other loose particles from exterior surfaces with clean water.
- (2) Wash with mild soap and warm water or with aircraft plastic cleaner. Use a soft cloth or sponge in a straight back and forth motion. Do not rub harshly.
- (3) Remove oil and grease with a cloth moistened with kerosene.

**CAUTION**

Do not use gasoline, alcohol, benzene, carbon tetrachloride, thinner, acetone, or window cleaning sprays.

- (4) After cleaning plastic surfaces, apply a thin coat of hard polishing wax. Rub lightly with a soft cloth. Do not use a circular motion.
- (5) A severe scratch or mar in plastic can be removed by rubbing out the scratch with jeweler's rouge. Smooth both sides and apply wax.

(e) Cleaning Headliner, Side Panels and Seats

- (1) Clean headliner, side panels, and seats with a stiff bristle brush, and vacuum where necessary.
- (2) Soiled upholstery, except leather, may be cleaned with a good upholstery cleaner suitable for the material. Carefully follow the manufacturer's instructions. Avoid soaking or harsh rubbing.

**CAUTION**

Solvent cleaners require adequate ventilation.

- (3) Leather should be cleaned with saddle soap or a mild hand soap and water.

(f) Cleaning Carpets

To clean carpets, first remove loose dirt with a whisk broom or vacuum. For soiled spots and stubborn stains use a nonflammable dry cleaning fluid. Floor carpets may be removed and cleaned like any household carpet.

**8.29 COLD WEATHER OPERATION**

For cold weather operation a winterization plate is installed on the inlet opening of the oil cooler. This plate should be installed whenever the ambient temperature reaches 50 F or less. The plate should be removed and stored in the cockpit when the ambient temperature exceeds 50 F.

It is recommended that an optional Engine Breather Tube Winterization Kit be installed for cold weather operation. This kit is available through your Piper Dealer/Distributor.

**THIS PAGE INTENTIONALLY LEFT BLANK**

## TABLE OF CONTENTS

SECTION 9  
SUPPLEMENTS

Paragraph No.		Page No.
9.1	General .....	9-1
1	Auxiliary Vacuum System.....(6 pages)	9-3
2	Bendix/King KLN 89B GPS Navigation System.....(12 pages)	9-9
3	Garmin GNS 430 VHF Comm/Nav/GPS.....(8 pages)	9-21
4	S-TEC Manual Electric Trim System.....	9-29
5	Garmin GTX 327 Transponder.....(10 pages)	9-31
6	S-TEC ADF 650A System.....(6 pages)	9-41
7	Garmin GMA 340 Audio Panel.....(6 pages)	9-47
8	S-TEC DME 450.....(4 pages)	9-53
9	Garmin GTX 330 Transponder.....(4 pages)	9-57
10	Avidyne FlightMax Entegra Primary Flight/Multi-Function Displays.....(30 pages)	9-61
11	Mid-Continent 4300-4XX Series Electric Attitude Indicator.....(4 pages)	9-89
12	S-TEC ADF-650D System.....(10 pages)	9-93
13	Avidyne FlightMax Entegra Primary Flight/Multi-Function Displays With The B&C Specialties BC410 Standby Alternator.....(36 pages)	9-103
14	Garmin GNS 430W VHS Comm/Nav/GPS.....(12 pages)	9-139

**TABLE OF CONTENTS (Continued)**

**SECTION 9  
SUPPLEMENTS**

Paragraph No.		Page No.
15	Bendix/King KR-87 Digital ADF with KI-227 Indicator .....(10 pages)	9-151
16	Bendix/King KN-63 DME .....(4 pages)	9-161



**SECTION 9  
SUPPLEMENTS**

**9.1 GENERAL**

This section provides information in the form of Supplements which are necessary for efficient operation of the airplane when equipped with one or more of the various optional systems and equipment not provided with the standard airplane.

All of the Supplements provided by this section are FAA Approved and consecutively numbered as a permanent part of this Handbook. The information contained in each Supplement applies only when the related equipment is installed in the airplane.

**THIS PAGE INTENTIONALLY LEFT BLANK**

**PILOT'S OPERATING HANDBOOK  
AND  
FAA APPROVED AIRPLANE FLIGHT MANUAL**

**SUPPLEMENT NO. 1  
FOR  
AUXILIARY VACUUM SYSTEM**

This supplement must be attached to the Pilot's Operating Handbook and FAA Approved Airplane Flight Manual when the Piper Auxiliary Vacuum System is installed in accordance with Piper Drawing 87774-2. The information contained herein supplements or supersedes the Pilot's Operating Handbook and FAA Approved Airplane Flight Manual only in those areas listed herein. For limitations, procedures and performance information not contained in this supplement, consult the Pilot's Operating Handbook and FAA Approved Airplane Flight Manual.

FAA APPROVED:



**PETER E. PECK  
D.O.A. NO. SO-1  
THE NEW PIPER AIRCRAFT, INC.  
VERO BEACH, FLORIDA**

DATE OF APPROVAL: July 12, 1995

**SECTION 1 - GENERAL**

This supplement supplies information necessary for the operation of the airplane when the optional Piper Auxiliary Vacuum System is installed. The information contained within this supplement is to be used in conjunction with the complete handbook.

**SECTION 2 - LIMITATIONS**

1. The auxiliary vacuum system is limited to standby function only. Take off with the engine driven dry air pump inoperative is not approved.
2. Discontinue flight in instrument meteorological conditions (IMC) if vacuum pressure falls below 4.8 In. Hg.
3. The auxiliary pump/motor assembly and elapsed time indicator must be removed from service after 500 hours accumulated operating time or 10 years, whichever occurs first.

**SECTION 3 - EMERGENCY PROCEDURES**

**LOSS OF VACUUM SUCTION - Vacuum inop (VAC) annunciator and VAC OFF warning lamp lit.**

1. Vacuum gauge.....Check to verify inoperative pump. If vacuum gauge reads below 4.5 inches of mercury:
2. Auxiliary vacuum switch.....Press AUX ON.
3. Verify vacuum pressure of 4.8 to 5.2 inches of mercury.
4. Verify VAC inop annunciator and VAC OFF lights go out.

**CAUTION**

Compass error may exceed 10 when auxiliary vacuum system is in operation.

5. Electrical load.....Monitor
  - a. Verify alternator capacity is not being exceeded.
  - b. If required, turn off nonessential electrical equipment.

**SECTION 4 - NORMAL PROCEDURES**

**A. Preflight Check.**

1. Set battery switch on and verify that VAC OFF lamp lights.

**NOTE**

Due to electrical power requirement of the auxiliary vacuum pump it is suggested that the engine be operating while making the following checks.

2. Turn on auxiliary vacuum pump on and verify AUX ON light is illuminated and electrical load is approximately 15 amps on ammeter.
3. Turn off auxiliary vacuum pump and verify AUX ON light goes out.

**B. Inflight Check - Prior to entering instrument flight conditions.**

1. Turn off non-essential electrical equipment.
2. Turn on auxiliary vacuum pump and verify AUX ON light illuminated and electrical load is approximately 11 amps on ammeter.
3. Turn off auxiliary vacuum pump and verify AUX ON light goes out.

**NOTE**

For maximum service life, avoid continuous non-emergency operation of the auxiliary vacuum pump.

**SECTION 5 - PERFORMANCE**

No change.

**SECTION 6 - WEIGHT & BALANCE**

Factory installed optional equipment is included in the licensed weight and balance data in section 6 of the Pilot's Operating Handbook.

**SECTION 7 - DESCRIPTION AND OPERATION**

The auxiliary dry air pump system provides an independent back-up source of pneumatic power to operate the gyro flight instruments in the event the engine driven air pump fails.

The auxiliary pump is mounted on the forward side of the firewall and connects to the primary system at a manifold downstream of the vacuum regulator. Isolation of the primary and auxiliary systems from each other is accomplished by check valves on each side of the manifold. The primary system vacuum switch is located on the regulator and senses vacuum supplied to the gyros.

A control switch (labeled AUX VAC) for the auxiliary pump system is located on the right side of the instrument panel near the vacuum suction gage.

The switch button incorporates two annunciator light sections labeled VAC OFF and AUX ON. The VAC OFF section is controlled by a vacuum switch in the primary pneumatic system and illuminates an amber light when the engine driven pump is inoperative or when the system vacuum falls below the switch activation level. The AUX ON section is controlled by a vacuum switch on the manifold and illuminates a blue light when the auxiliary pump is operating and creating a vacuum in the system. When the auxiliary pump is activated at high altitude, or if the system has developed air leaks, the AUX ON light may fail to illuminate. This indicates that the system vacuum is still below the AUX ON switch activation level even though the auxiliary pump is operating. The annunciator lights do not incorporate a press-to-test feature, if the lights do not illuminate as expected, check for burned out lamps, replace with MS25237-330 bulbs and retest the system.

System electrical protection is provided by a 20 amp circuit breaker in the pump motor circuit and a 5 amp circuit breaker in the annunciator light circuit. The breakers are mounted on the circuit breaker panel.

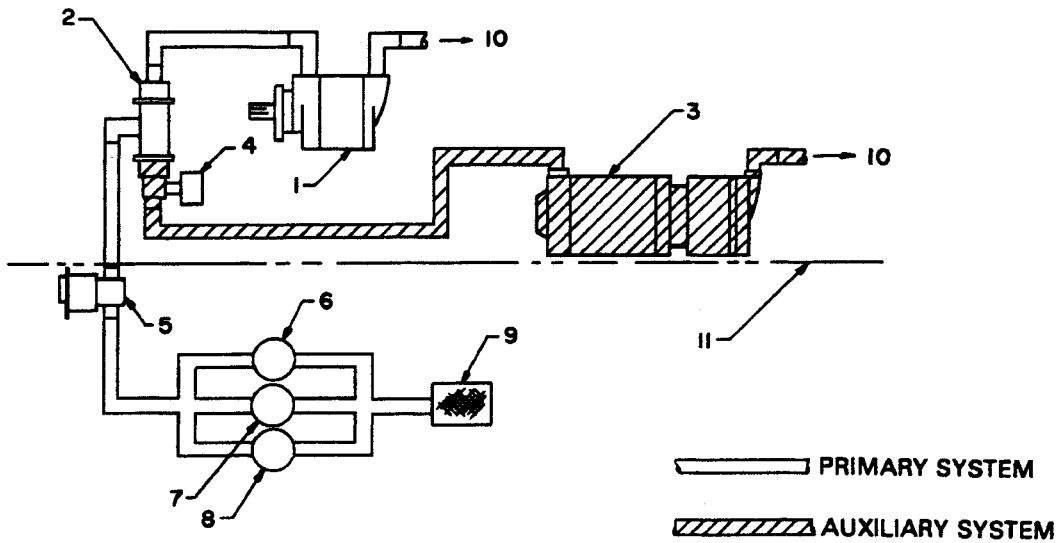

1. ENGINE DRIVEN DRY AIR PUMP
2. MANIFOLD & CHECK VALVE ASSY.
3. AUX. ELECTRICALLY DRIVEN DRY AIR PUMP
4. PRESSURE SENSING SWITCH
5. SYSTEM REGULATOR & PRESS. SENSING SWITCH
6. VACUUM (SUCTION) GAUGE

7. ATTITUDE GYRO
8. DIRECTIONAL GYRO
9. FILTER
10. OVERBOARD VENT
11. FIREWALL

**THIS PAGE INTENTIONALLY LEFT BLANK**



**PILOT'S OPERATING HANDBOOK  
AND  
FAA APPROVED AIRPLANE FLIGHT MANUAL**

**SUPPLEMENT NO. 2  
FOR  
BENDIX/KING KLN 89B GPS  
NAVIGATION SYSTEM**

This supplement must be attached to the Pilot's Operating Handbook and FAA Approved Airplane Flight Manual when the KLN 89B GPS Navigation System is installed per the Equipment List. The information contained herein supplements or supersedes the Pilot's Operating Handbook and FAA Approved Airplane Flight Manual only in those areas listed herein. For limitations, procedures and performance information not contained in this supplement, consult the Pilot's Operating Handbook and FAA Approved Airplane Flight Manual.

FAA APPROVED: 

PETER E. PECK  
D.O.A. NO. SO-1  
THE NEW PIPER AIRCRAFT, INC.  
VERO BEACH, FLORIDA

DATE OF APPROVAL: September 12, 1995

**SECTION 1 GENERAL**

The KLN 89B GPS panel mounted unit contains the GPS sensor, the navigation computer, a CRT display, and all controls required to operate the unit. It also houses the data base card which plugs directly into the front of the unit.

The data base card is an electronic memory containing information on airports, navaids, intersections, SID's, STAR's, instrument approaches, special use airspace, and other items of value to the pilot.

Every 28 days, Bendix/King receives new data base information from Jeppesen Sanderson for the North American data base region. This information is processed and downloaded onto the data base cards. Bendix/King makes these data base card updates available to KLN 89B GPS users.

Provided the KLN 89B GPS navigation system is receiving adequate usable signals, it has been demonstrated capable of and has been shown to meet the accuracy specifications of:

VFR/IFR en route oceanic and remote, en route domestic, terminal, and instrument approach (GPS, Loran-C, VOR, VOR-DME, TACAN, NDB, NDB-DME, RNAV) operation within the U.S. National Airspace System, North Atlantic Minimum Navigation Performance Specifications (MNPS) Airspace and latitudes bounded by 74° North and 60° South using the WGS44 (or NAD 83) coordinate reference datum in accordance with the criteria of AC 20-138, AC 91-49, and AC 120-33. Navigation data is based upon use of only the global positioning system (GPS) operated by the United States.

**NOTE**

Aircraft using GPS for oceanic IFR operations may use the KLN 89B to replace one of the other approved means of long-range navigation. A single KLN 89B GPS installation may also be used on short oceanic routes which require only one means of longrange navigation.

**NOTE**

FAA approval of the KLN 89B does not necessarily constitute approval for use in foreign airspace.

**SECTION 2- LIMITATIONS**

A. The KLN 89B GPS Pilot's Guide, P/N 006-08786-0000, dated May, 1995 (or later applicable revision) must be immediately available to the flight crew whenever navigation is predicated on the use of the system. The Operational Revision Status (ORS) of the Pilot's Guide must match the ORS level annunciated on the Self Test page.

B. IFR Navigation is restricted as follows:

1. The system must utilize ORS level 01 or later FAA approved revision.
2. The data on the self test page must be verified prior to use.
3. IFR en route and terminal navigation is prohibited unless the pilot verifies the currency of the data base or verifies each selected waypoint for accuracy by reference to current approved data.
4. Instrument approaches must be accomplished in accordance with approved instrument approach procedures that are retrieved from the KLN 89B data base. The KLN 89B data base must incorporate the current update cycle.
  - (a) The KLN 89B Quick Reference, P/N 006-08787-0000, dated 5/95 (or later applicable revision) must be immediately available to the flight crew during instrument approach operations.
  - (b) Instrument approaches must be conducted in the approach mode and RAIM must be available at the Final Approach Fix.
  - (c) APR ACTV mode must be annunciated at the Final Approach Fix.
  - (d) Accomplishment of ILS, LOC, LOC-BC, LDA, SDF, and MLS approaches are not authorized.
  - (e) When an alternate airport is required by the applicable operating rules, it must be served by an approach based on other than GPS or Loran-C navigation.
  - (f) The KLN 89B can only be used for approach guidance if the reference coordinate datum system for the instrument approach is WGS 84 or NAD-83. (All approaches in the KLN 89B data base use the WGS-84 or the NAD-83 geodetic datums.)
5. The aircraft must have other approved navigation equipment appropriate to the route of flight installed and operational.

**SECTION 3- EMERGENCY PROCEDURES  
ABNORMAL PROCEDURES**

- A. If the KLN 89B GPS information is not available or invalid, utilize remaining operational navigation equipment as required.
- B. If a "RAIM NOT AVAILABLE" message is displayed while conducting an instrument approach, terminate the approach. Execute a missed approach if required.
- C. If a "RAIM NOT AVAILABLE" message is displayed in the en route or terminal phase of flight, continue to navigate using the KLN 89B or revert to an alternate means of navigation appropriate to the route and phase of flight. When continuing to use GPS navigation, position must be verified every 15 minutes using another IFR approved navigation system.
- D. Refer to the KLN 89B Pilot's Guide, Appendices B and C, for appropriate pilot actions to be accomplished in response to annunciated messages.

**SECTION 4 - NORMAL PROCEDURES**

**WARNING**

Familiarity with the en route operation of the KLN 89B does not constitute proficiency in approach operations. Do not attempt approach operations in IMC prior to attaining proficiency in the use of the KLN 89B.

**A. OPERATION**

Normal operating procedures are outlined in the KLN 89B GPS Pilot's Guide, P/N 006-08786-0000, dated May 1995, (or later applicable revision). A KLN 89B Quick Reference, P/N 006-08787-0000 dated 5/ 95 (or later applicable revision) containing an approach sequence, operating bps and approach related messages is intended for cockpit use by the KLN 89B familiar pilot when conducting instrument approaches.

**B. SYSTEM ANNUNCIATORS/SWITCHES/CONTROLS**

1. HSI NAV presentation (NAV/GPS) switch annunciator- May be used to select data for presentation on the pilot's HSI; either NAV data from the number one navigation receiver or GPS data from the KLN 89B GPS. Presentation on the HSI is also required for autopilot coupling. NAV is green. GPS is blue.

**NORMAL PROCEDURES**

2. **Message (MSG) annunciator** - Will flash to alert the pilot of a situation that requires attention. Press the MSG button on the KLN 89B GPS to view the message. (Appendix B of the KLN 89B Pilot's Guide contains a list of all of the message page messages and their meanings). **MSG** is amber.
3. **Waypoint (WPT) annunciator** - Prior to reaching a waypoint in the active flight plan, the KLN 89B GPS will provide navigation along a curved path segment to ensure a smooth transition between two adjacent legs in the flight plan. This feature is called turn anticipation. Approximately 20 seconds prior to the beginning of turn anticipation the WPT annunciator will flash, going solid upon initialization of the turn, and extinguishing upon turn completion. **WPT** is amber.

**WARNING**

Turn anticipation is automatically disabled for FAF waypoints and those used exclusively in SID/STARS where overflight is required. For waypoints shared between SID/STARS and published en route segments (requiring overflight in the SID/ STARS), proper selection on the presented waypoint page is necessary to provide adequate route protection on the SID/STARS.

4. **HSI course control**  knob - Provides analog course input to the KLN 89B in **OBS** when the NAV/GPS switch/annunciator is in **GPS**. When the NAV/GPS switch annunciation is in **NAV**, GPS course selection in **OBS** mode is digital through the use of the controls and display at the KLN 89B. The HSI course control knob must also be set to provide proper course datum to the autopilot if coupled to the KLN 89B in **LEG** or **OBS**.

**NOTE**

Manual HSI course centering in **OBS** using the control knob can be difficult, especially at long distances. Centering the dbar can best be accomplished by pressing  and then manually setting the HSI pointer to the course value prescribed in the KLN 89B displayed message.

NORMAL PROCEDURES

5. GPS approach (GPS APR ARM/ACTV) switch/annunciator - Used to (a) manually select or deselect approach ARM (or deselect approach ACTV) and (b) annunciate the stage of approach operation either armed (ARM) or activated (ACTV). Sequential button pushes if in ACTV would first result in approach ARM and then approach arm canceled. Subsequent button pushes will cycle between the armed state (if an approach is in the flight plan) and approach arm canceled. Approach ACTV cannot be selected manually. GPS APR and ARM are white. ACTV is green.
6. RMI NAV presentation switch - May be used to select data for presentation on the RMI; either NAV 1 data from the number one navigation receiver, NAV 2 data from the number two navigation receiver or GPS data from the KLN 89B GPS.

C. PILOTS DISPLAY

Left/right steering information is presented on the pilot's HSI as a function of the NAV/GPS switch position.

D. AUTOPILOT COUPLED OPERATION

The KLN 89B may be coupled to the autopilot by first selecting GPS on the NAV/GPS switch. Manual selection of the desired track on the pilot's HSI course pointer is required to provide course datum to the autopilot. (Frequent manual course pointer changes may be necessary, such as in the case of flying a DME arc.) The autopilot approach mode (APR) should be used when conducting a coupled GPS approach.

NOTE

Select HDG mode for DME arc intercepts. NAV or APR coupled DME arc intercepts can result in excessive overshoots (aggravated by high ground speeds and/or intercepts from inside the arc).

**NORMAL PROCEDURES**

**E. ALTITUDE ALERT AURAL TONES r**

- 1000 feet prior to reaching the selected altitude - three short tones.
- Upon reaching the selected altitude - two short tones.
- Deviating above or below the selected altitude by more than the warn altitude - four short tones.

**F. APPROACH MODE SEQUENCING AND RAIM PREDICTION**

**NOTE**

The special use airspace alert will automatically be disabled prior to flying an instrument approach to reduce the potential for message congestion.

1. Prior to arrival, select a STAR if appropriate from the **APT 7** page. Select an approach and an initial approach fix (IAF) from the **APT 8** page.

**NOTES**

- Using the outer knob, select the **ACT** (Active Flight Plan Waypoints) pages. Pull the inner knob out and scroll to the destination airport, then push the inner knob in and select the **ACT 7** or **ACT 8** page.
  - To delete or replace a SID, STAR or approach, select **FPL 0** page. Place the cursor over the name of the procedure, press **ENT** to change it, or **CLR** then **ENT** to delete it.
2. En route, check for RAIM availability at the destination airport ETA on the **OTH 3** page.

**NOTE**

RAIM must be available at the FAF in order to fly an instrument approach. Be prepared to terminate the approach upon loss of RAIM.

NORMAL PROCEDURES

3. At 30 nm from the airport:
  - a. Verify automatic annunciation of APR ARM.
  - b. Note automatic dbar scaling change from  $\pm 5.0$  nm to  $\pm 1.0$  nm over the next 30 seconds.
  - c. Update the KLN 89B altimeter baro setting as required.
  - d. Internally the KLN 89B will transition from en route to terminal integrity monitoring.
4. Select NAV 4 page to fly the approach procedure.
  - a. If receiving radar vectors, or need to fly a procedure turn or holding pattern, fly in OBS until inbound to the FAF.

NOTE

OBS navigation is TO-FROM (like a VOR) without waypoint sequencing.

- b. **NoPT** routes including DME arc's are flown in **LEG**. LEG is mandatory from the FAF to the MAP.

NOTE

Select HDG mode for DME arc intercepts. NAV or APR coupled DME arc intercepts can result in excessive overshoots (aggravated by high ground speeds and/or intercepts from inside the arc).

WARNING

Flying final outbound from an off airport vortac on an overlay approach; beware of the DME distance increasing on final approach, and the GPS distance-to waypoint decreasing, and not matching the numbers on the approach plate!

5. At or before 2 nm from the FAF inbound:
  - a. Select the FAF as the active waypoint, if not accomplished already.
  - b. Select LEG operation.



## NORMAL PROCEDURES

6. Approaching the FAF inbound (within 2 nm.):
  - a. Verify APR ACTV.
  - b. Note automatic dbar scaling change from  $\pm 1.0$  nm to  $\pm 0.3$  nm over the 2 nm inbound to the FAF.
  - c. Internally the KLN 89B will transition from terminal to approach integrity monitoring.
7. Crossing the FAF and APR ACTV is not annunciated:
  - a. Do not descend.
  - b. Execute the missed approach.
8. Missed Approach:
  - a. Climb
  - b. Navigate to the MAP (in APR ARM if APR ACTV is not available).

## NOTE

There is no automatic LEG sequencing at the MAP.

- c. After climbing in accordance with the published missed approach procedure, press  verify or change the desired holding fix and press ENT.

## GENERAL NOTES

- The data base must be up to date for instrument approach operation.
- Only one approach can be in the flight plan at a time.
- If the destination airport is the active waypoint at the time of the instrument approach selection, the active waypoint will shift automatically to the chosen IAF.
- Checking RAIM prediction for your approach while en route using the OTH 3 page is recommended. A self check occurs automatically within 2 nm of the FAF. APR ACTV is inhibited without RAIM.
- Data cannot be altered, added to or deleted from the approach procedures contained in the data base. (DME arc intercepts may be relocated along the arc through the NAV4 or the FPL 0 pages).
- Some approach waypoints do not appear on the approach plates (including in some instances the FAF)!

NORMAL PROCEDURES

- Waypoint suffixes in the flight plan:
  - i - IAF
  - f - FAF
  - m - MAP
  - h missed approach holding fix.
- The DME arc IAF (arc intercept waypoint) will be a) on your present position radial off the arc VOR when you load the IAF into the flight plan, or b) the beginning of the arc if currently on a radial beyond the arc limit. To adjust the arc intercept to be compatible with a current radar vector, bring up the arc IAF waypoint in the NAV 4 page scanning field or under the cursor on the FPL 0 page, press CLR, then ENT. Fly the arc in LEG. adjust the HSI or CDI course pointer with reference to the desired track value on the NAV 4 page (it will flash to remind you). Left/right dbar information is relative to the arc. Displayed distance is not along the arc but direct to the active waypoint. (The ARC radial is also displayed in the lower right corner of the NAV 4 page.)
- The DME arc IAF identifier may be unfamiliar. Example: D098G where 098 stands for the 098° radial off the referenced VOR, and G is the seventh letter in the alphabet indicating a 7 DME arc.

**NORMAL PROCEDURES**

- **APR ARM** to **APR ACTV** is automatic provided:
  - a. You are in **APR ARM** (normally automatic).
  - b. You are in **LEG** mode!
  - c. The **FAF** is the active waypoint!
  - d. Within 2 n.m. of the **FAF**.
  - e. Outside of the **FAF**.
  - f. Inbound to the **FAF**.
  - g. **RAIM** is available.
- Direct-To operation between the **FAF** and **MAP** cancels **APR ACTV**. Fly the missed approach in **APR ARM**.
- Flagged navigation inside the **FAF** may usually be restored (not guaranteed) by pressing the **GPS APR** button changing from **ACTV** to **ARM**. Fly the missed approach.
- The instrument approach using the **KLN 89B** may be essentially automatic starting 30 nm out (with a manual baro setting update) or it may require judicious selection of the **OBS** and **LEG** modes.
- **APR ARM** may be canceled at any Time by pressing the **GPS APR** button. (A subsequent press will reselect it.)

**SECTION 5- PERFORMANCE**

No change.

**SECTION 6- WEIGHT AND BALANCE**

Factory installed optional equipment is included in the licensed weight and balance data in Section 6 of the Basic Pilot's Operating HANdbook.

**THIS PAGE INTENTIONALLY LEFT BLANK**

**PILOT'S OPERATING HANDBOOK  
AND  
FAA APPROVED AIRPLANE FLIGHT MANUAL**

**SUPPLEMENT NO. 3  
FOR  
GARMIN GNS 430 VHF COMMUNICATION  
TRANSCEIVER/VOR/ILS RECEIVER/GPS RECEIVER  
(Serial Numbers 2842064 and up)**

This supplement must be attached to the Pilot's Operating Handbook and FAA Approved Airplane Flight Manual when the Garmin GNS 430 VHF Communication Transceiver/VOR/ILS Receiver/Global Positioning System is installed per the Equipment List. The information contained herein supplements or supersedes the Pilot's Operating Handbook and FAA Approved Airplane Flight Manual only in those areas listed herein. For limitations, procedures and performance information not contained in this supplement, consult the Pilot's Operating Handbook and FAA Approved Airplane Flight Manual.

FAA APPROVED: *Christina L. Marsh*  
CHRISTINA L. MARSH  
D.O.A. NO. SO-1  
THE NEW PIPER AIRCRAFT, INC.  
VERO BEACH, FLORIDA

DATE OF APPROVAL: NOVEMBER 30, 1999

ISSUED: JULY 12, 1995  
REVISED: NOVEMBER 30, 1999

REPORT: VB-1610 |  
1 of 8 9-21 |

**SECTION 1 - GENERAL**

The GNS 430 System is a fully integrated, panel mounted instrument, which contains a VHF Communications Transceiver, a VOR/ILS receiver, and a Global Positioning System (GPS) Navigation computer. The system consists of a GPS antenna, GPS receiver, VHF VOR/LOC/GS antenna, VOR/ILS receiver, VHF COMM antenna and a VHF Communications transceiver. The primary function of the VHF Communication portion of the equipment is to facilitate communication with Air Traffic Control. The primary function of the VOR/ILS Receiver portion of the equipment is to receive and demodulate VOR, Localizer, and Glide Slope signals. The primary function of the GPS portion of the system is to acquire signals from the GPS system satellites, recover orbital data, make range and Doppler measurements, and process this information in real-time to obtain the user's position, velocity, and time.

Provided the GARMIN GNS 430's GPS receiver is receiving adequate usable signals, it has been demonstrated capable of and has been shown to meet the accuracy specifications for:

VFR/IFR enroute, terminal, and non-precision instrument approach (GPS, Loran-C, VOR, VOR-DME, TACAN, NDB, NDB-DME, RNAV) operation within the U.S. National Airspace System in accordance with AC 20-138.

North Atlantic Minimum Navigation Performance Specification (MNPS) Airspace in accordance with AC 91-49 and AC 120-33.

Navigation is accomplished using the WGS-84 (NAD-83) coordinate reference datum. Navigation data is based upon use of only the Global Positioning System (GPS) operated by the United States of America.

## SECTION 2 - LIMITATIONS

- A. The GARMIN GNS 430 Pilot's Guide, p/n 190-00140-00, Rev. A, dated October 1998, or later appropriate revision, must be immediately available to the flight crew whenever navigation is predicated on the use of the system.
- B. The GNS 430 must utilize the following or later FAA approved software versions:

Sub-System	Software Version
Main	2.00
GPS	2.00
COMM	2.00
VOR/LOC	2.00
G/S	2.00

The main software version is displayed on the GNS 430 self test page immediately after turn-on for 5 seconds. The remaining system software versions can be verified on the AUX group sub-page 2, "SOFTWARE/DATABASE VER".

- C. IFR enroute and terminal navigation predicated upon the GNS 430's GPS Receiver is prohibited unless the pilot verifies the currency of the data base or verifies each selected waypoint for accuracy by reference to current approved data.
- D. Instrument approach navigation predicated upon the GNS 430's GPS Receiver must be accomplished in accordance with approved instrument approach procedures that are retrieved from the GPS equipment data base. The GPS equipment data base must incorporate the current update cycle.
1. Instrument approaches utilizing the GPS receiver must be conducted in the approach mode and Receiver Autonomous Integrity Monitoring (RAIM) must be available at the Final Approach Fix.

SECTION 2 - LIMITATIONS (continued)

2. Accomplishment of ILS, LOC, LOC-BC, LDA, SDF, MLS or any other type of approach not approved for GPS overlay with the GNS 430's GPS receiver is not authorized.
  3. Use of the GNS 430 VOR/ILS receiver to fly approaches not approved for GPS require VOR/ILS navigation data to be present on the external indicator.
  4. When an alternate airport is required by the applicable operating rules, it must be served by an approach based on other than GPS or Loran-C navigation, the aircraft must have the operational equipment capable of using that navigation aid, and the required navigation aid must be operational.
  5. VNAV information may be utilized for advisory information only. Use of VNAV information for Instrument Approach Procedures does not guarantee Step-Down Fix altitude protection, or arrival at approach minimums in normal position to land.
- E. If not previously defined, the following default settings must be made in the "SETUP 1" menu of the GNS 430 prior to operation (refer to Pilot's Guide for procedure if necessary):
1. dis, spd.....<sup>n</sup>/<sub>m</sub> kt (sets navigation units to "nautical miles" and "knots")
  2. alt, vs.....<sup>f</sup>t fpm (sets altitude units to "feet" and "feet per minute")
  3. map datum..WGS 84 (sets map datum to WGS-84, see not below)
  4. posn.....deg-min (sets navigation grid units to decimal minutes)

NOTE

In some areas outside the United States, datums other than WGS-84 or NAD-83 may be used. If the GNS 430 is authorized for use by the appropriate Airworthiness authority, the required geodetic datum must be set in the GNS 430 prior to its use for navigation.



**SECTION 3 - EMERGENCY PROCEDURES**

**ABNORMAL PROCEDURES**

- A. If GARMIN GNS 430 navigation information is not available or invalid, utilize remaining operational navigation equipment as required.
- B. If "RAIM POSITION WARNING" message is displayed the system will flag and no longer provide GPS based navigational guidance. The crew should revert to the GNS 430 VOR/ILS receiver or an alternate means of navigation other than the GNS 430's GPS receiver.
- C. If "RAIM IS NOT AVAILABLE" message is displayed in the enroute, terminal, or initial approach phase of flight, continue to navigate using the GPS equipment or revert to an alternate means of navigation other than the GNS 430's GPS receiver appropriate to the route and phase of flight. When continuing to use GPS navigation, position must be verified every 15 minutes using the GNS 430's VOR/ILS receiver or another IFR-approved navigation system.
- D. If "RAIM IS NOT AVAILABLE" message is displayed while on the final approach segment, GPS based navigation will continue for up to 5 minutes with approach CDI sensitivity (0.3 nautical mile). After 5 minutes the system will flag and no longer provide course guidance with approach sensitivity. Missed approach course guidance may still be available with 1 nautical mile CDI sensitivity by executing the missed approach.
- E. In an in-flight emergency, depressing and holding the Comm transfer button for 2 seconds will select the emergency frequency of 121.500 Mhz into the "Active" frequency window.

**SECTION 4 - NORMAL PROCEDURES**

**WARNING**

Familiarity with the enroute operation of the GNS 430 does not constitute proficiency in approach operations. Do not attempt approach operations in IMC prior to attaining proficiency in the use of the GNS 430 approach feature.

**A. DETAILED OPERATING PROCEDURES**

Normal operating procedures are described in the GARMIN GNS 430 Pilot's Guide, p/n 190-00140-00, Rev. A, dated October 1998, or later appropriate revision.

**B. PILOT'S DISPLAY**

The GNS 430 System data will appear on the Pilot's HSI. The source of data is either GPS or VLOC as annunciated on the display above the CDI key.

**C. AUTOPILOT/FLIGHT DIRECTOR OPERATION**

Coupling of the GNS 430 System steering information to the autopilot/flight director can be accomplished by engaging the autopilot/flight director in the NAV or APR mode.

When the autopilot/flight director system is using course information supplied by the GNS 430 System and the course pointer is not automatically driven to the desired track, the course pointer on the HSI must be manually set to the desired track (DTK) indicated by the GNS 430. For detailed autopilot/flight director operational instructions, refer to the FAA Approved Flight Manual Supplement for the autopilot/flight director.

**SECTION 4 - NORMAL PROCEDURES (continued)**

**D. AUTOMATIC LOCALIZER COURSE CAPTURE**

By default, the GNS 430 automatic localizer course capture feature is enabled. This feature provides a method for system navigation data present on the external indicators to be switched automatically from GPS guidance to localizer / glide slope guidance at the point of course intercept on a localizer at which GPS derived course deviation equals localizer derived course deviation. If an offset from the final approach course is being flown, it is possible that the automatic switch from GPS course guidance to localizer / glide slope course guidance will not occur. It is the pilot's responsibility to ensure correct system navigation data is present on the external indicator before continuing a localizer based approach beyond the final approach fix.

**SECTION 5 - PERFORMANCE**

No change.

**SECTION 6 - WEIGHT AND BALANCE**

Factory installed optional equipment is included in the licensed weight and balance data in Section 6 of the basic Pilot's Operating Handbook.

**SECTION 7 - DESCRIPTION AND OPERATION**

See GNS 430 Pilot's Guide for a complete description of the GNS 430 system.

**THIS PAGE INTENTIONALLY LEFT BLANK**

**PILOT'S OPERATING HANDBOOK  
AND  
FAA APPROVED AIRPLANE FLIGHT MANUAL**

**SUPPLEMENT NO. 4  
FOR  
S-TEC MANUAL ELECTRIC TRIM SYSTEM  
WITH TRIM MONITOR  
(Serial numbers 2842019 and up)**

The FAA approved operational supplement for the S-TEC Manual Electric Trim System, installed in accordance with STC SA8388SW-D, is required for operation of this system. S-TEC will be responsible to supply and revise the operational supplement. It is permitted to include the S-TEC supplement in this location of the Pilot's Operating Handbook unless otherwise stated by S-TEC. The information contained in the S-TEC supplement may supersede or supplement the information in the basic Pilot's Operating Handbook and FAA Approved Airplane Flight Manual with respect to the operation of the S-TEC Manual Electric Trim System. For limitations, procedures and performance information not contained in the S-TEC supplement, consult the basic Pilot's Operating Handbook and FAA Approved Airplane Flight Manual.

**THIS PAGE INTENTIONALLY LEFT BLANK**

**PILOT'S OPERATING HANDBOOK  
AND  
FAA APPROVED AIRPLANE FLIGHT MANUAL  
  
SUPPLEMENT NO. 5  
FOR  
GARMIN GTX 327 TRANSPONDER**

This supplement must be attached to the Pilot's Operating Handbook and FAA Approved Airplane Flight Manual when the Garmin GTX 327 Transponder is installed per the Equipment List. The information contained herein supplements or supersedes the Pilot's Operating Handbook and FAA Approved Airplane Flight Manual only in those areas listed herein. For limitations, procedures and performance information not contained in this supplement, consult the Pilot's Operating Handbook and FAA Approved Airplane Flight Manual.

FAA APPROVED: Christina L. Marsh  
CHRISTINA L. MARSH  
D.O.A. NO. SO- 1  
THE NEW PIPER AIRCRAFT, INC.  
VERO BEACH, FLORIDA

DATE OF APPROVAL: DECEMBER 21, 2000

**SECTION 1 - GENERAL**

This supplement supplies information necessary for the operation of the airplane when the Garmin GTX 327 Transponder is installed in accordance with FAA approved Piper data.

**SECTION 2 - LIMITATIONS**

No change.

**SECTION 3 - EMERGENCY PROCEDURES**

To transmit an emergency signal:

- Mode Selection Key - ALT
- Code Selection - SELECT 7700

To transmit a signal representing loss of all communications:

- Mode Selection Key - ALT
- Code Selection - SELECT 7600



**SECTION 4 - NORMAL PROCEDURES**

**BEFORE TAKEOFF:**

- To transmit Mode C (Altitude Reporting) code in flight:
- Mode Selection Key - ALT
- Code Selector Keys - SELECT assigned code.

To transmit Mode A (Aircraft Identification) code in flight:

- Mode Selector Key - ON
- Code Selector Keys - SELECT assigned code.

**NOTE**

During normal operation with the ON mode selected, the reply indicator "R" flashes, indicating transponder replies to interrogations.

**NOTE**

Mode A reply codes are transmitted in ALT also; however, Mode C codes only are suppressed when the Function Selector ON key is selected.

**SECTION 5 - PERFORMANCE**

No change.

**SECTION 6 - WEIGHT AND BALANCE**

Factory installed optional equipment is included in the licensed weight and balance data in section 6 of the Airplane Flight Manual.

## SECTION 7 - DESCRIPTION AND OPERATION

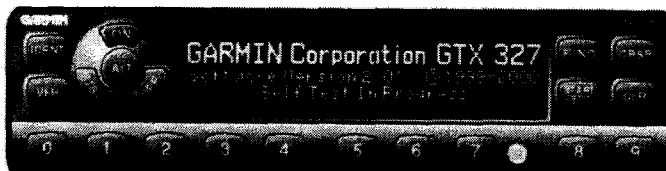

The GTX 327 transponder is powered on by pressing the **STBY**, **ALT** or **ON** keys, or by a remote avionics master switch (if applicable). After power on, a start-up page will be displayed while the unit performs a self test.

### Mode Selection Keys

**OFF** - Powers off the GTX 327.

**STBY** - Powers on the transponder in standby mode.

At power on the last active identification code will be selected. When in standby mode, the transponder will not reply to any interrogations.

**ON** - Powers on the transponder in Mode A. At power on the last active identification code will be selected. In this mode, the transponder replies to interrogations, as indicated by the Reply Symbol . Replies do not include altitude information.

**ALT** - Powers on the transponder in Mode A and Mode C. At power on the last active identification code will be selected. In ALT mode, the transponder replies to identification and altitude interrogations, as indicated by the Reply Symbol . Replies to altitude interrogations include the standard pressure altitude received from an external altitude source, which is not adjusted for barometric pressure. The ALT mode may be used in aircraft not equipped with the optional altitude encoder; however, the reply signal will not include altitude information.

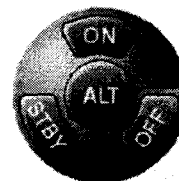

### GTX 327 Configuration Mode

The GTX 327's configuration, which is normally done at time of installation, influences many of the unit's functions described in this manual. If you wish to view or change any of the GTX 327 configuration parameters, you may access the GTX 327 Configuration Mode. Use caution when changing configuration. When in doubt, contact your authorized GARMIN Aviation Service Center. The Configuration Mode should not be used while the aircraft is airborne.

## SECTION 7 - DESCRIPTION AND OPERATION (continued)

## GTX 327 Configuration Mode (continued)

## To use the GTX 327 Configuration Mode:

1. Press and hold the FUNC key while powering on the unit using the STBY, ON, or ALT key (or using an avionics master switch).
2. Press the FUNC key to sequence through the configuration pages.
3. Use the CRSR key to highlight selectable fields on each page.
4. When a field is highlighted, enter numeric data using the 0 - 9 keys, and select items from a list using the 8 or 9 keys.
5. Press the CRSR key to confirm list selections.

## Code Selection



Code selection is done with eight keys (0 - 7) that provide 4,096 active identification codes. Pushing one of these keys begins the code selection sequence. The new code will not be activated until the fourth digit is entered. Pressing the CLR key will move the cursor back to the previous digit. Pressing the CLR key when the cursor is on the first digit of the code, or pressing the CRSR key during code entry, will remove the cursor and cancel data entry, restoring the previous code. The numbers 8 and 9 are not used for code entry, only for entering a Count Down time, and in the Configuration Mode.



**SECTION 7 - DESCRIPTION AND OPERATION (continued)**

**Code Selection (continued)**

**Important Codes:**

- 1200** - The VFR code for any altitude in the US (Refer to ICAO standards elsewhere)
- 7000** - The VFR code commonly used in Europe (Refer to ICAO standards)
- 7500** - Hijack code (Aircraft is subject to unlawful interference)
- 7600** - Loss of communications
- 7700** - Emergency
- 7777** - Military interceptor operations (Never squawk this code)
- 0000** - Military use (Not enterable)

Care should be taken not to select the code 7500 and all codes in the 7600 - 7777 range, which trigger special indicators in automated facilities. Only the code 7500 will be decoded as the hijack code. An aircraft's transponder code (when available) is utilized to enhance the tracking capabilities of the ATC facility, therefore care should be taken when making routine code changes.

**Keys for Other GTX 327 Functions**



**IDENT** - Pressing the IDENT key activates the Special Position Identification (SPI) Pulse for 18 seconds, identifying your transponder return from others on the air traffic controller's screen. The word "IDENT" will appear in the upper left corner of the display while the IDENT mode is active.





**VFR** - Sets the transponder code to the pre-programmed VFR code selected in Configuration Mode (this is set to 1200 at the factory). Pressing the VFR key again will restore the previous identification code.





**FUNC** - Changes the page shown on the right side of the display. Displayed data includes Pressure Altitude, Flight Time, Count Up timer, Count Down timer, and may include Contrast and Display Brightness, depending on configuration (as shown in the screens below):

**SECTION 7 - DESCRIPTION AND OPERATION (continued)****Keys for Other GTX 327 Functions (continued)**

 **PRESSURE ALT:** Displays the altitude data supplied to the GTX 327 in feet, hundreds of feet (i.e., flight level), or meters, depending on configuration.

 **FLIGHT TIME:** Displays the Flight Time, which is controlled by the **START/STOP** key or by a squat switch as configured during installation. With squat switch control, the timer begins when lift off is sensed and pauses when landing is sensed.

 **COUNT UP TIMER:** Controlled by **START/STOP** and **CLR** keys.

 **COUNT DOWN TIMER:** Controlled by **START/STOP**, **CLR**, and **CRSR** keys. The initial Count Down time is entered with the **0 - 9** keys.

 **CONTRAST:** This page is only displayed if manual contrast mode is selected in Configuration Mode. Contrast is controlled by the **8** and **9** keys.

 **DISPLAY:** This page is only displayed if manual backlighting mode is selected in Configuration Mode. Backlighting is controlled by the **8** and **9** keys.



**START/STOP** - Starts and stops the Count Up and Count Down timers.



**CRSR** - Initiates entry of the starting time for the Count Down timer and cancels transponder code entry.



**CLR** - Resets the Count Up and Count Down timers and cancels the previous keypress during code selection.



**8** - Reduces Contrast and Display Brightness when the respective pages are displayed. Also enters the number 8 into the Count Down timer.



**9** - Increases Contrast and Display Brightness when the respective pages are displayed. Also enters the number 9 into the Count Down timer.

**SECTION 7 - DESCRIPTION AND OPERATION (continued)**

**Altitude Trend Indicator**

When the "PRESSURE ALT" page is displayed, an arrow may be displayed to the right of the altitude, indicating that the altitude is increasing or decreasing. One of two sizes of arrows may be displayed depending on the rate of climb/descent. The sensitivity of these arrows is set using the GTX Configuration Mode.

**Timer Operation**

**To operate the Flight Timer:**

1. Press the FUNC key until "FLIGHT TIME" is displayed.
2. If the GTX 327 is configured as having a squat switch installed, the timer will begin counting automatically when the squat switch senses that the aircraft has become airborne.
3. If desired, you may press **START/STOP** to pause or restart the timer.
4. Press **CLR** to reset the timer to zero.
5. If the GTX 327 is configured as having a squat switch installed, the timer will pause automatically when the squat switch senses that the aircraft has touched down.

**To operate the Count Up timer:**

1. Press the FUNC key until "COUNT UP" is displayed.
2. If necessary, press **CLR** to reset the Count Up timer to zero.
3. Press **START/STOP** to count up.
4. Press **START/STOP** again to pause the timer.
5. Press **CLR** to reset the timer to zero.

**To operate the Count Down timer:**

1. Press the FUNC key until "COUNT DOWN" is displayed.
2. Press **CRSR** and use the **0 - 9** keys to set the initial time. All digits must be entered (use the 0 key to enter leading zeros).
3. Press **START/STOP** to count down.
4. Press **START/STOP** again to pause the timer.
5. When the Count Down timer expires, the words "COUNT DOWN" are replaced with "EXPIRED", and the time begins counting up and flashing.
6. Press **CLR** to reset the timer to the initial time value.

**SECTION 7 - DESCRIPTION AND OPERATION (continued)**

**Automatic ALT/STBY Mode Switching**

If the GTX 327 is configured for automatic standby switching, the mode will automatically change to ALT when a squat switch senses that the aircraft has become airborne. Also, the mode will change to STBY automatically when a squat switch senses that the aircraft has touched down. Additionally, a delay time can be set in the Configuration Mode, causing the GTX 327 to wait a specified length of time after landing before automatically changing to STBY mode.

**THIS PAGE INTENTIONALLY LEFT BLANK**



**PILOT'S OPERATING HANDBOOK  
AND  
FAA APPROVED AIRPLANE FLIGHT MANUAL**

**SUPPLEMENT NO. 6  
FOR  
S-TEC ADF-650A SYSTEM**

This supplement must be attached to the Pilot's Operating Handbook and FAA Approved Airplane Flight Manual when the S-TEC ADF-650A System is installed per the Equipment List. The information contained herein supplements or supersedes the Pilot's Operating Handbook and FAA Approved Airplane Flight Manual only in those areas listed herein. For limitations, procedures and performance information not contained in this supplement, consult the Pilot's Operating Handbook and FAA Approved Airplane Flight Manual.

FAA APPROVED:



CHRISTINA L. MARSH

D.O.A. NO. SO- 1

THE NEW PIPER AIRCRAFT, INC.

VERO BEACH, FLORIDA

DATE OF APPROVAL: January 2, 2001

**SECTION 1 - GENERAL**

This supplement supplies information necessary for the operation of the airplane when the S-TEC ADF-650A System is installed in accordance with FAA approved Piper data.

**SECTION 2 - LIMITATIONS**

No change.

**SECTION 3 - EMERGENCY PROCEDURES**

No change.

**SECTION 4 - NORMAL PROCEDURES**

**To operate as an Automatic Direction Finder:**

- OFF/VOL Control - ON
- Frequency Selector Knobs - SELECT desired frequency.
- ADF SPEAKER/PHONE Selector Switch (on audio control panel) - SELECT as desired.
- OFF/VOL Control - SET to desired volume level.
- ADF Mode Control - Select ADF mode and note relative bearing on display.

**ADF Test (Pre-flight or In-flight):**

- ADF Mode Control - Select ADF mode and note relative bearing on display.
- Press the TEST button and note the pointer moves to 90° from its prior position. Excessive pointer sluggishness, wavering or reversals indicate a signal that is too weak or a system malfunction.

**To Operate BFO:**

- OFF/VOL Control - ON
- Frequency Selector Knobs - SELECT desired frequency.
- ADF SPEAKER/PHONE Selector Switch (on audio control panel) - SELECT as desired.
- ADF Mode Control - Select BFO mode.
- OFF/VOL Control - Set to desired volume level.

**SECTION 5 - PERFORMANCE**

No change.

**SECTION 6 - WEIGHT AND BALANCE**

Factory installed optional equipment is included in the licensed weight and balance data in Section 6 of the Pilot's Operating Handbook and Airplane Flight Manual.

SECTION 7 - DESCRIPTION AND OPERATION

The S-TEC ADF-650A System operates over a frequency range of 200 through 1799 kHz in 1-kHz increments. Three operating modes are included as part of the ADF-650 System.

- BFO
- ANT
- ADF

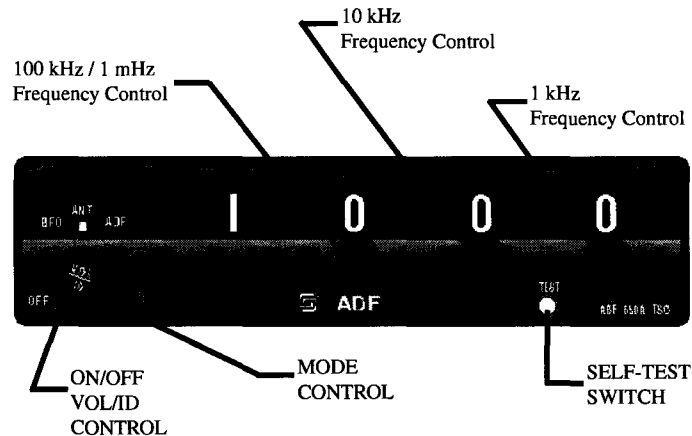

ADF-650A Receiver, Controls, and Indicators

Figure 1

**BFO Mode**

The BFO (beat frequency oscillator) and ADF (automatic direction finding) modes are navigation modes that result in pointing operation when in-range station is selected. The ADF mode is used with conventional nondirectional beacons and AM broadcast stations. The BFO mode is used to aurally identify stations that employ keyed cw rather than amplitude modulation techniques.

**NOTE**

CW signals (Morse Code) are unmodulated and no audio will be heard without use of BFO. This type of signal is not used in the United States air navigation. It is used in some foreign countries and marine beacons.

**SECTION 7 - DESCRIPTION AND OPERATION (continued)**

**ANT (Antenna) Mode**

The ANT (antenna) mode cannot be used for navigation; this mode enhances audio reception clarity and is normally used for station identification.

**ADF Mode**

Automatic Direction Finder (ADF) mode is used for navigation. This mode activates the bearing pointer. The bearing pointer will point in the direction of the station relative to the aircraft heading.

**Frequency Selector Controls**

Three controls are used to select the system operating frequency. The right hand control selects 1 - kHz increments, the center control 10 - kHz increments, and the left hand control 100 - kHz increments.

**Self Test Switch**

Pressing and holding the spring loaded self test switch while in the ADF mode will cause the bearing pointer to rotate 90 degrees from its prior position if the ADF-650 system is operating properly. When the test switch is released, the bearing pointer should promptly return to its starting point. At this time, normal operation is restored.

**ON/OFF/VOL/ID Control**

This control performs three independent functions. In full ccw position, no power is applied to the system; rotating the control cw applies power and continued rotation increases volume. Pulling the knob out enhances the Morse code station identifier when background noise is present; push the knob to hear voice transmissions. A good operating practice is to pull the knob out for station identification purposes and then push it back in after positive identification has been made.

**THIS PAGE INTENTIONALLY LEFT BLANK**

**PILOT'S OPERATING HANDBOOK  
AND  
FAA APPROVED AIRPLANE FLIGHT MANUAL**

**SUPPLEMENT NO. 7  
FOR  
GARMIN GMA 340 AUDIO PANEL**

This supplement must be attached to the Pilot's Operating Handbook and FAA Approved Airplane Flight Manual when the Garmin GMA 340 is installed per the Equipment List. The information contained herein supplements or supersedes the information in the basic Pilot's Operating Handbook and FAA Approved Airplane Flight Manual only in those areas listed herein. For limitations, procedures, and performance information not contained in this supplement, consult the basic Pilot's Operating Handbook and FAA Approved Airplane Flight Manual.

FAA APPROVED



CHRISTINA L. MARSH  
D.O.A. NO. SO-1  
THE NEW PIPER AIRCRAFT, INC.  
VERO BEACH, FLORIDA

DATE OF APPROVAL January 2, 2001

**SECTION 1 - GENERAL**

This supplement supplies information necessary for the operation of the airplane when the Garmin GMA 340 audio panel is installed in accordance with FAA approved Piper data.

**SECTION 2 - LIMITATIONS**

No change.

**SECTION 3 - EMERGENCY PROCEDURES**

No change.

**SECTION 4 - NORMAL PROCEDURES**

**AUDIO CONTROL SYSTEM OPERATION:**

- Select the desired transmitter audio selector button (COM1, COM2, OR COM3) and verify that the buttons LED is illuminated.
- INTERCOM VOL Control (ICS) - Adjust to desired listening level.
- INTERCOM VOX (voice) Sensitivity Control - ROTATE CONTROL knob clockwise to the middle range and then adjust as required for desired voice activation or hot mic intercom.
- If desired, select the speaker function button. Selecting this button allows radio transmissions to be received over the cabin speaker.

**NOTE**

Audio level is controlled by the selected NAV radio volume control.

**MARKER BEACON RECEIVER OPERATION:**

- TEST Button - PRESS to verify all marker lights are operational.
- SENS Button - SELECT HI for airway flying for LO for ILS/LOC approaches.



**SECTION 5 - PERFORMANCE**

No change.

**SECTION 6 - WEIGHT AND BALANCE**

Factory installed optional equipment is included in the licensed weight and balance data in section 6 of the Airplane Flight Manual.

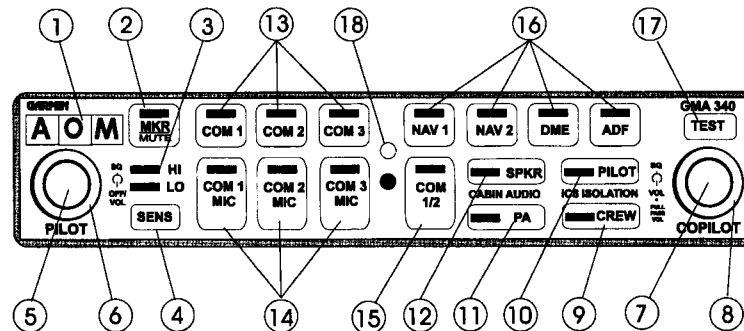
**SECTION 7 - DESCRIPTION AND OPERATION**

1. Marker Beacon Lamps
2. Marker Beacon Receiver Audio Select/Mute Button
3. Marker Beacon Receiver Sensitivity Selection Indicator LED
4. Marker Beacon Receiver Sensitivity Selection Button
5. Unit On/Off, Pilot Intercom System (ICS) Volume
6. Pilot ICS Voice Activated (VOX) Intercom Squelch Level
7. Copilot and Passenger ICS Volume Control (Pull out for Passenger Volume)
8. Copilot/Passenger VOX Intercom Squelch Level
9. Crew Isolation Intercom Mode Button
10. Pilot Isolation Intercom Mode Button
11. Passenger Address (PA) Function Button
12. Speaker Function Button
13. Transceiver Audio Selector Buttons (COM1, COM2, COM3)
14. Transmitter (Audio/Mic) Selection Buttons
15. Split COM Button
16. Aircraft Radio Audio Selection Buttons (NAV1, NAV2, DME, ADF)
17. Annunciator Test Button
18. Photocell - Automatic Annunciator Dimming

**SECTION 7 - DESCRIPTION AND OPERATION (continued)**

**ON/OFF, Pilot Intercom System (ICS) Volume Control**

The GMA 340 is powered OFF when the left small knob (5) is rotated fully CCW into the detent. To turn the unit ON, rotate the knob clockwise past the click. The knob then functions as the pilot ICS volume control. A fail safe circuit connects the pilot's headset and microphone directly to COM1 in case power is interrupted or the unit is turned OFF.

**Transceivers**

Selection of either COM1, COM2, or COM3 for both MIC and audio source is accomplished by pressing either COM1, MIC, COM2 MIC, COM3 MIC (14). The active COM audio is always heard on the headphones.

Additionally, each audio source can be selected independently by pressing COM1, COM2, or COM3 (13). When selected this way, they remain active as audio sources regardless of which transceiver has been selected for microphone use.

When a microphone is keyed, the active transceiver's MIC button LED blinks approximately one per second to indicate that the radio is transmitting.

**NOTE**

Audio level is controlled by the selected COM radio volume controls.

**Split COM**

Pressing the COM 1/2 button (15) activates the split COM function. When this mode is active, COM1 is dedicated solely to the pilot for MIC/Audio while COM2 is dedicated to the copilot for MIC/Audio. The pilot and copilot can simultaneously transmit in this mode over separate radios. Both pilots can still listen to COM3, NAV1, NAV2, DME, ADF, and MRK as selected. The split COM mode is cancelled by pressing the COM 1/2 button a second time.

When in the split COM mode the copilot may make PA announcements while the pilot continues using COM1 independently. When the PA button is pressed after the split com mode is activated the copilot's mic is output over the cabin speaker when keyed. A second press of the PA button returns the copilot to normal split COM operation.

**SECTION 7 - DESCRIPTION AND OPERATION (continued)**

**Aircraft Radios and Navigation**

Pressing NAV1, NAV2, DME, ADF (16) or MRK (2) selects each audio source. A second button press deselects the audio.

**Speaker Output**

Pressing the SPKR button (12) selects the aircraft radios over the cabin speaker. The speaker output is muted when a COM microphone is keyed.

**PA Function**

The PA mode is activated by pressing the PA button (11). Then, when either the pilot's or copilot's microphone is keyed, the corresponding mic audio is heard over the cabin speaker. If the SKR button is also active, then any selected speaker audio is muted while the microphone is keyed. The SPKR button does not have to be previously active in order to use the PA function.

**Intercom System (ICS)**

Intercom volume and squelch (VOX) are adjusted using the following front panel knobs:

- **Left Small Knob** - Unit ON/OFF power control and pilot's ICS volume. Full CCW detent position is OFF.
- **Left Large Knob** - Pilot ICS mic VOX squelch level. CW rotation increases the amount of mic audio (VOX level) required to break squelch. Full CCW is the "HOT MIC" position (no squelch).
- **Right Small Knob** - IN position: Copilot ICS volume. OUT position: Passenger ICS volume.
- **Right Large Knob** - Copilot and passenger mic VOX squelch level. CW rotation increases the amount of mic audio (VOX level) required to break squelch. Full CCW is the "HOT MIC" position.
- **PILOT Mode** - This mode isolates the pilot from everyone else and dedicates the aircraft radios to the pilot exclusively. The copilot and passengers share communications between themselves but cannot communicate with the pilot or hear the aircraft radios.
- **CREW Mode** - This mode places the pilot and copilot on a common ICS communication channel with the aircraft radios. The passengers are on their own intercom channel and can communicate with each other, but cannot communicate with the crew or hear the aircraft radios.

**SECTION 7 - DESCRIPTION AND OPERATION (continued)**

**Marker Beacon Receiver**

The GMA 340's marker beacon receiver controls are located on the left side of the front panel (1 - 4). The SENS button selects either high or low sensitivity as indicated by the HI or LO LED being lit. Low sensitivity is used on ILS approaches while high sensitivity allows operation over airway markers or to get an earlier indication of nearing the outer marker during an approach.

The marker audio is initially selected by pressing the MKR/Mute button (2). If no beacon signal is received, then a second button press will deselect the marker audio. This operation is similar to selecting any other audio source on the GMA 340. However, if the second button press occurs while a marker beacon signal is received, then the marker audio is muted but not deselected. The button's LED will remain lit to indicate that the source is still selected. When the current marker signal is no longer received, the audio is automatically un-muted. While in the muted state, pressing the MKR/Mute button deselects the marker audio. The button's LED will extinguish to indicate that the marker audio is no longer selected.

**PILOT'S OPERATING HANDBOOK  
AND  
FAA APPROVED AIRPLANE FLIGHT MANUAL**

**SUPPLEMENT NO. 8  
FOR  
S-TEC DME-450**

This supplement must be attached to the Pilot's Operating Handbook and FAA Approved Airplane Flight Manual when the S-TEC DME-450 is installed per the Equipment List. The information contained herein supplements or supersedes the Pilot's Operating Handbook and FAA Approved Airplane Flight Manual only in those areas listed herein. For limitations, procedures and performance information not contained in this supplement, consult the Pilot's Operating Handbook and FAA Approved Airplane Flight Manual.

FAA APPROVED: Christina L. Marsh  
CHRISTINA L. MARSH  
D.O.A. NO. SO- 1  
THE NEW PIPER AIRCRAFT, INC.  
VERO BEACH, FLORIDA

DATE OF APPROVAL: January 2, 2001

**SECTION 1 - GENERAL**

The S-TEC DME-450 system is a full feature, solid state, remote mounted system with full 200 channel capability. For long distance operation, it provides a full 100 watts maximum pulse power transmitter output.

The IND-450 indicator (see figure 1) provides selectable read-out of distance to/from the station, ground speed, and time to/from the station. Features also include automatic display dimming and waypoint annunciation.

**SECTION 2 - LIMITATIONS**

No change.

**SECTION 3 - EMERGENCY PROCEDURES**

No change.

**SECTION 4 - NORMAL PROCEDURES**

**DME OPERATION**

- DME Mode Selector Switch - Set to DME 1 or DME 2
- NAV 1 and NAV 2 VHF Navigation Receivers - ON; SET FREQUENCY to VOR/DME station frequencies, as required.

**NOTE**

When the VOR frequency is selected, the appropriate DME Frequency is automatically channeled.

- DME audio selector button (on audio selector panel) - SET to desired mode.

**SECTION 5 - PERFORMANCE**

No change.

## SECTION 6 - WEIGHT AND BALANCE

Factory installed optional equipment is included in the licensed weight and balance data in Section 6 of the Pilot's Operating Handbook and Airplane Flight Manual.

## SECTION 7 - DESCRIPTION AND OPERATION



IND-450

Figure 1

1. DISTANCE DISPLAY (NM) - DME distance to VORTAC/WAYPOINT displayed in .1 nautical mile increments up to 99.9 NM, then in increments of one nautical mile.
2. GROUND SPEED DISPLAY (KTS) - Displays ground speed in knots to or from VORTAC/WAYPOINT up to 999 knots (aircraft must be flying directly to or from the VORTAC/WAYPOINT for true ground speed indication).
3. TIME TO STATION DISPLAY (MIN) - Displays time to station (VORTAC/WAYPOINT) in minutes up to 99 minutes (aircraft must be flying directly to or from the VORTAC/WAYPOINT for true time to the station indication).

**7 - DESCRIPTION AND OPERATION (continued)**

4. DME ON/OFF SWITCH - Turns DME power on or off.

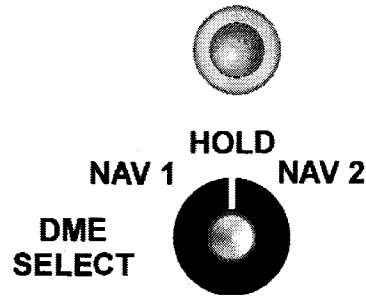

**Mode Selector Switch**

Figure 2

5. DME MODE SELECTOR SWITCH (NAV 1, HOLD, NAV 2) - Selects DME operating mode as follows:

NAV 1 - Selects DME operation with NO. 1 VHF navigation set; enables channel selection by NAV 1 frequency selector controls.

HOLD - Selects DME memory circuit; DME remains channeled to station to which it was last channeled when HOLD was selected and will continue to display information relative to this channel. Allows both the NAV 1 and NAV 2 navigation receivers to be set to new operational frequencies without affecting the previously selected DME operation.

**NOTE**

In the HOLD mode there is no annunciation of the VOR/DME station frequency. However, an annunciator light located above the HOLD position of the selector illuminates to inform the pilot that the DME is in the HOLD mode.

NAV 2 - Selects DME operation with NO. 2 VHF navigation set; enables channel selection by NAV 2 frequency selector controls.



**PILOT'S OPERATING HANDBOOK  
AND  
FAA APPROVED AIRPLANE FLIGHT MANUAL**

**SUPPLEMENT NO. 10  
FOR  
AVIDYNE FLIGHTMAX ENTEGRA  
PRIMARY FLIGHT/MULTI-FUNCTION DISPLAYS**

This supplement must be attached to the Pilot's Operating Handbook and FAA Approved Airplane Flight Manual when the optional Avidyne FlightMax Entegra Primary Flight and Multi-Function Displays are installed per the Equipment List. The information contained herein supplements or supersedes the basic Pilot's Operating Handbook and FAA Approved Airplane Flight Manual only in those areas listed herein. For limitations, procedures and performance information not contained in this supplement, consult the Pilot's Operating Handbook and FAA Approved Airplane Flight Manual.

FAA APPROVED:



LINDA J. DICKEN

DOA-510620-CE

THE NEW PIPER AIRCRAFT, INC.

VERO BEACH, FLORIDA

DATE OF APPROVAL: OCTOBER 7, 2004ISSUED: JULY 12, 1995  
REVISED: JANUARY 9, 2006REPORT: VB-1610  
1 of 30, 9-61|

### SECTION 1 - GENERAL

This airplane is equipped with the Avidyne FlightMax Entegra EXP5000 series 700-00006-0XX-( ) Primary Flight Display with software to the latest revision per Avidyne website and EX5000 series 700-00004-0XX-( ) Multi-Function Display with software to the latest revision per Avidyne website, herein referred to as the "PFD" and "MFD". The PFD is intended to be the primary display of primary flight and essential engine parameter information to the pilot. The PFD is capable of interfacing with a pair of Garmin GNS 430/530's, and an S-TEC System 55X autopilot.

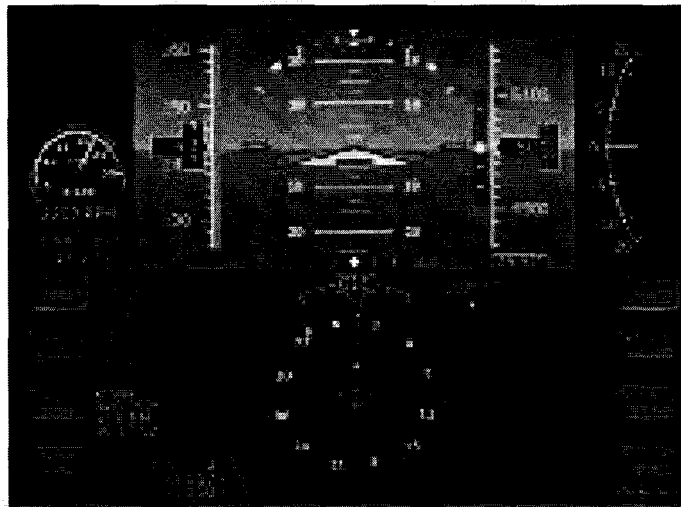

Figure 1 - Entegra 700-00006-0XX-( ) Primary Flight Display

The PFD provides the display of the following aircraft parameters:

- Artificial Horizon
- Airspeed Indication
- Altimeter
- Vertical Speed Indication
- Rate of Turn Indicator
- Skid/Slip Indicator
- Horizontal Situation Indication
- RMI
- Course Deviation Indication
- Outside Air Temperature
- Engine RPM
- Fuel Flow
- Oil Pressure
- Autopilot Annunciation

**SECTION 1 - GENERAL (continued)**

The MFD is intended to be a supplemental display of situational and navigation information to the pilot. Its primary function is to provide a moving map display to the pilot for increased situational awareness. The MFD is capable of accepting data from a variety of GPS sensors, the BFG WX-500 Stormscope passive thunderstorm detection unit, Engine Sensor Unit, and either the L3 Skywatch Traffic Advisory System (TAS), Bendix/King TAS, or the Ryan Traffic and Collision Alert Device (TCAD) system. The unit is organized around logical groupings of information presented on “Pages”.

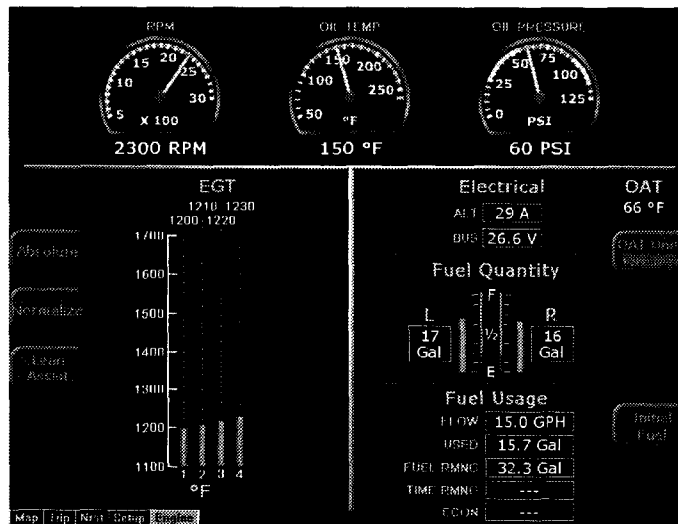

Figure 2 - EX5000 series 700-00004-0XX-( ) Multi-Function Display

The MFD provides the display of the following aircraft parameters:

- Engine RPM
- Engine Oil Temperature
- Engine Oil Pressure
- EGT
- Cylinder Head Temperature
- Aircraft Electrical Status
- Outside Air Temperature
- Fuel Quantity
- Fuel Usage Data

**SECTION 2 - LIMITATIONS**

**A. PFD Limitations**

1. IFR flight is prohibited when the PFD or any standby instrument is inoperative (altimeter, airspeed indicator, artificial horizon, or whiskey compass).
2. IFR flight is prohibited upon aircraft total loss of essential engine parameter display (manifold pressure, tachometer, fuel flow).
3. The Avidyne FlightMax Entegra series Primary Flight Display Pilot's Guide, p/n 600-00104-000 revision 00 or appropriate later revision, or p/n 600-00143-000 revision 01 (EXP 5000 R6) or appropriate later revision, must be available to the pilot during all flight operations.
4. If a VOR or Localizer (VLOC) navigation source is displayed on the HSI and GPSS mode is engaged on the autopilot, the autopilot will track the active flight plan in the GPS corresponding to the selected VLOC source selected for display on the HSI (i.e. GPS1 for VLOC1 or GPS2 for VLOC2). This configuration is potentially confusing and must be avoided.
5. GPSS mode must not be used on the final approach segment of a VLOC approach (ILS, LOC or non-GPS-overlay VOR). GPSS mode must be deselected (i.e., NAV mode selected) prior to the turn onto the final approach course.

**NOTE**

The PFD integrates with separately approved sensor and flight control installations. Adherence to limitations in appropriate installation AFM supplements is mandatory.

**B. MFD Limitations**

1. The Avidyne moving map display provides visual advisory of the airplane's GPS position against a moving map. This information supplements CDI course deviation and information presented on the GPS navigator. The moving map display must not be used as the primary navigation instrument.
2. Use of Map page during IFR flight requires an IFR approved GPS receiver and installation, operated in accordance with its applicable limitations.
3. The Avidyne FlightMax EX-series Pilot's Guide, p/n 600-00105-000 revision 00 or appropriate later revision, must be available to the pilot during all flight operations.

**SECTION 2 - LIMITATIONS (continued)****B. MFD Limitations (continued)**

4. Aircraft dispatch is prohibited when the MFD is inoperative.
5. Selecting "Lightning Display OFF" for the Lightning overlay of the Map page will prevent current heading values from being sent to the WX500 sensor from the EX5000.

When "Lightning Display OFF" is selected the EX5000 will stop sending current heading values to the WX500. When this selection is made, the WX500 will still use the last heading value that was present before this selection even though the actual aircraft heading may have changed since that selection was made.

Consequently, the Stormscope heading information provided to the Garmin 430 by the EX5000 will not be updated, resulting in an inaccurate lightning depiction on the Garmin 430. This issue does not affect the lightning display on the EX5000.

To avoid this invalid condition, **disable the WX500 on the GNS430**. For instructions on how to accomplish this, refer to the Garmin 400 Series Installation Manual, p/n 190-00140-02, latest revision (reference Section 5.1 Configuration Mode Operations, Section 5.2 Installation Configuration pages, and Section 5.2.2 Main RS232 Configuration page).

**CAUTION**

Traffic information shown on the Map page display is provided to the pilot as an aid to visually acquiring traffic. Pilot's should maneuver their aircraft based only on ATC guidance or positive visual acquisition of the conflicting traffic. Maneuvers should be consistent with ATC instructions. No maneuvers should be based only on a Traffic Advisory.

Terrain information shown on the Map page display is provided to the pilot as an aid to situational awareness. The Map page terrain color representations should not be used as a basis for terrain avoidance.

**NOTE**

The MFD integrates with separately approved sensor and flight control installations. Adherence to limitations in appropriate installation AFM supplements is mandatory.

**SECTION 2 - LIMITATIONS (continued)**

**C. CMAX CHART PAGE Limitations**

The geographic referenced aircraft symbol must not be used for navigation.

**NOTE**

The aircraft symbol displayed provides supplemental aircraft situational awareness information. It is not intended as a means for navigation or flight guidance. The airplane symbol is not to be used for conducting instrument approaches or departures. Position accuracy, orientation, and related guidance must be assumed by other means or required navigation.

Operators with the optional CMax Chart Page must have back-up charts available. Do not rely upon CMax charts as your sole source of navigation information.

**THIS PAGE INTENTIONALLY LEFT BLANK**

### SECTION 3 - EMERGENCY PROCEDURES

#### Failure of Pilot's Electronic Attitude Direction Display Screen (PFD)

**Indication: PFD Display goes blank.**

Standby Attitude Gyro .....VERIFY ON and  
flag is pulled on gyro

Maintain attitude control using standby gyro and establish the aircraft in straight and level unaccelerated flight.

**If time and conditions permit:**

PFD Brightness Control (BRT/DIM) .....Run to full bright  
PFD Circuit Breaker .....PULL and RESET

*If PFD Screen cannot be reinstated:*

On aircraft equipped with the optional second Nav Indicator (OBS):

Mechanical Nav Indicator (OBS).....Utilize for primary navigation  
Engine Instruments.....Refer to Engine page of MFD

#### NOTE

The Mechanical Nav Indicator (OBS) receives nav information directly from the No. 2 nav/com/GPS. Only VLOC information is available.

Maintain attitude, airspeed and heading control using standby instruments, magnetic compass and other directional indications (such as MFD, MAP/NAV page).

#### CAUTION

High current loads in the vicinity of the magnetic compass can influence its accuracy. Depending on the flight conditions, the pilot must reduce these loads as much as possible to insure accuracy. Tests have shown that air conditioner and pitot heat contribute to significant heading errors of the magnetic compass. These items should be turned OFF prior to comparing magnetic compass headings.

*Land as soon as practical.*



**SECTION 3 - EMERGENCY PROCEDURES (continued)****Loss of PFD Engine Data**

**Indication:** Indicator needle removed from dial and digital readout replaced with white dashes.

Engine Instruments ..... Refer to Engine page of MFD

*Land as soon as practical.*

**Invalid Air Data**

**Indication:** Airspeed, Altimeter, and Vertical Speed data replaced with Red X's.

Maintain aircraft airspeed and altitude by referring to the standby airspeed and altimeter.

**If time and conditions permit:**

PFD Circuit Breaker ..... PULL and RESET

**If air data is still invalid:**

Refer to standby airspeed indicator and altimeter.

*Land as soon as practical.*

**Invalid Heading Data**

**Indication:** Heading Bug and Heading Data removed and replaced with Red X's.

**If time and conditions permit:**

PFD Circuit Breaker ..... PULL and RESET

Maintain heading control using magnetic compass and other directional indications (such as MFD, MAP/NAV page).

**CAUTION**

High current loads in the vicinity of the magnetic compass can influence its accuracy. Depending on the flight conditions, the pilot must reduce these loads as much as possible to insure accuracy. Tests have shown that air conditioner and pitot heat contribute to significant heading errors of the magnetic compass. These items should be turned OFF prior to comparing magnetic compass headings.

*Land as soon as practical.*

**SECTION 3 - EMERGENCY PROCEDURES (continued)**

**Invalid Attitude and Heading Data**

**Indication: Attitude and Heading Data removed and replaced with Red X's.**

Standby Attitude Gyro .....VERIFY ON and  
flag is pulled on gyro.

Maintain attitude control using standby gyro.

**If time and conditions permit:**

PFD Circuit Breaker .....PULL and RESET

**If attitude and heading data is still invalid:**

Maintain attitude control by using standby gyro.

Maintain heading control by utilizing magnetic compass and other directional indications (such as MFD, MAP/NAV page).

**CAUTION**

High current loads in the vicinity of the magnetic compass can influence its accuracy. Depending on the flight conditions, the pilot must reduce these loads as much as possible to insure accuracy. Tests have shown that air conditioner and pitot heat contribute to significant heading errors of the magnetic compass. These items should be turned OFF prior to comparing magnetic compass headings.

*Land as soon as practical.*

**SECTION 3 - EMERGENCY PROCEDURES (continued)****Failure of Attitude, Airspeed and Heading Reference System (ADAHRS)****Indication: Airspeed, Attitude, Heading and Altitude replaced with Red X's.**Standby Attitude Gyro .....VERIFY ON and  
flag is pulled on gyro

Maintain attitude control using standby gyro.

**If time and conditions permit:**

PFD Circuit Breaker .....PULL and RESET

*If ADAHRS initialization does not occur:*

On aircraft equipped with the optional second Nav Indicator (OBS):

Mechanical Nav Indicator (OBS).....Utilize for primary navigation

Engine Instruments.....Refer to Engine page of MFD

**NOTE**

The Mechanical Nav Indicator (OBS) receives nav information directly from the No. 2 nav/com/GPS. Only VLOC information is available.

Maintain attitude, airspeed and heading control using standby instruments, magnetic compass and other directional indications (such as MFD, MAP/NAV page).

**CAUTION**

High current loads in the vicinity of the magnetic compass can influence its accuracy. Depending on the flight conditions, the pilot must reduce these loads as much as possible to insure accuracy. Tests have shown that air conditioner and pitot heat contribute to significant heading errors of the magnetic compass. These items should be turned OFF prior to comparing magnetic compass headings.

***Land as soon as practical.***

**SECTION 3 - EMERGENCY PROCEDURES (continued)**

**Cross Check Monitor**

**Indication: Yellow Crosscheck Attitude Annunciator on PFD.**

Establish aircraft in straight and level unaccelerated flight.

Aircraft Attitude .....Crosscheck aircraft attitude  
with standby attitude gyro

**Total Loss of Engine Instruments**

**Indication: Indicator needle removed from dial and digital readout replaced with white dashes.**

DAU Circuit Breaker .....PULL and RESET

**If engine data is still invalid:**

**NOTE**

The following engine messages will be displayed on the MFD if an exceedance is detected:

- Check Oil Temp
- Check Oil Press
- Check CHT
- Check RPM
- Check EGT

*If failure occurs during takeoff:*

Mixture .....Maintain full rich

Throttle .....Full power

***Return to airport for landing.***

*If failure occurs during climb or landing:*

Mixture .....Maintain full rich

Throttle .....As required

***Land as soon as practical.***

*If failure occurs after setting cruise power and mixture:*

Power .....Maintain power setting

***Land as soon as practical.***

*If failure occurs prior to or during descent:*

Mixture .....Full rich

Throttle .....Set for 500 feet per minute  
descent at 126 KIAS

**SECTION 3 - EMERGENCY PROCEDURES (continued)****Alternator Failure**

**Indication: Alternator Inop annunciator light illuminated and zero current displayed on MFD alternator indication source.**

**NOTE**

Anytime the bus voltage is below 25 Vdc, the Low Bus Voltage annunciator will be illuminated.

Verify Failure.....Check ammeter

**If ammeter shows zero:**

ALTR switch .....OFF

Reduce electrical load to minimum:

ALTNR FIELD C/B .....CHECK and RESET as required

ALTR Switch .....ON

**WARNING**

Compass error may exceed 10 degrees with alternator inoperative.

**CAUTION**

Any power interruption will result in loss of attitude information from the PFD until the unit can be reinstated on the ground.

**NOTE**

Consider using the autopilot to reduce workload. Using the GPSS mode can assist in maintaining a flight-planned route.

**NOTE**

LO BUS VOLTAGE annunciator will be illuminated. Anticipate complete electrical failure. Duration of battery power available will be dependent on electrical load and battery condition prior to failure.

**SECTION 3 - EMERGENCY PROCEDURES (continued)**

**Alternator Failure (continued)**

**If power is not restored:**

ALTR Switch.....OFF

Reduce electrical loads by switching OFF or pulling circuit breakers for all non-essential equipment to include the following:

- Reduce PFD and MFD brightness as part of overall electrical system management
- Pitot heat (unless required)
- Airconditioner and ventilation fan (if installed)
- Landing light (use sparingly)
- Strobe lights
- Recognition lights (if equipped)
- Cabin/flood lights
- No. 2 nav/com/GPS
- Autopilot
- Electric trim
- DME (unless required for published approach)
- Stormscope (if equipped)
- Skywatch (if equipped)

***Land as soon as practical.***

**SECTION 3 - EMERGENCY PROCEDURES (continued)****Complete Electrical Failure**

Standby Attitude Gyro .....SELECT Standby (STBY) power button

**CAUTION**

The STBY PWR annunciator will rapidly flash for approximately one minute when aircraft power is lost. STBY PWR must be selected, otherwise the gyro will auto shutdown after approximately one minute.

Standby Attitude Gyro .....VERIFY ON and  
flag is pulled on gyro

Maintain aircraft control with reference to the standby airspeed, altimeter, and attitude gyro indicators.

Battery Switch .....OFF

Ground Clearance Switch (if installed) .....ON

**Land as soon as possible.****WARNING**

Compass error may exceed 10 degrees with alternator inoperative.

**NOTE**

Turning ON the ground clearance switch will activate the No. 1 nav/com/GPS radio.

**SECTION 3 - EMERGENCY PROCEDURES (continued)**

**Fire in Flight**

***Electrical Fire***

Fire.....Extinguish  
Standby Attitude Gyro .....VERIFY ON and  
flag is pulled on gyro

Maintain aircraft control with reference to the standby airspeed, altimeter, and  
attitude gyro indicators.

Battery Master Switch.....OFF  
ALTR Switch.....OFF  
Ground Clearance Switch (if installed) .....ON

**NOTE**

Turning ON the ground clearance switch will activate the  
No. 1 nav/com/GPS radio.

Vents .....OPEN  
Cabin Heat .....OFF

***Land as soon as practical.***

**WARNING**

Compass error may exceed 10 degrees with alternator  
inoperative.



**SECTION 3 - EMERGENCY PROCEDURES (continued)****Aircraft Engine Power Loss**

During an engine failure the pilot may elect to attempt an engine restart. During this time large voltage drops may cause the PFD to lose power and reinitialize. During this initialization process the PFD may not be able to complete a fast alignment during flight and therefore the pilot may have to obtain aircraft attitude and aircraft control using the standby instruments.

- Refer to the Emergency Section of the Pilot's Operating Handbook.
- If the PFD is able to perform fast alignment, when prompted by the PFD:
  - Maintain straight and level flight

**OR**

- If engine does not restart, maintain wings level and appropriate aircraft speed.
- Press the fast erect button.
- If the PFD was not able to perform fast alignment, maintain aircraft control with reference to the standby instruments for aircraft attitude information.

**CAUTION**

In case of engine failure, minimize the use of the starter and turn off all non-essential electrical equipment to preserve battery capacity.

**Loss of Fuel Flow**

Electric Fuel Pump .....ON  
Fuel Selector .....Check on tank containing usable fuel

**Engine Driven Fuel Pump Failure**

Throttle .....RETARD  
Electric Fuel Pump .....ON  
Throttle.....RESET as required

**CAUTION**

If normal engine operation and fuel flow is not immediately re-established, the electric fuel pump should be turned OFF. The lack of fuel flow indication while the electric pump is on could indicate a leak in the fuel system or fuel exhaustion. If fuel system leak is verified, switch fuel selector to OFF.

**SECTION 3 - EMERGENCY PROCEDURES (continued)**

**Loss of Heading Accuracy**

Indication:

- Difficulty maintaining course while using VOR or GPS.
- Excessive difference between heading and track required maintaining a VOR or GPS course.
- ATC indicates the aircraft is on a wrong heading.
- Excessive deviation between PFD heading and Whiskey Compass. (>10° after compass deviation applied.)

If heading systems differ by more than 10° (after compass deviation applied):

- Use Whiskey Compass for primary heading reference.

***CAUTION***

High current loads in the vicinity of the Whiskey Compass can influence its accuracy. Depending on the flight conditions, the pilot must reduce these loads as much as possible to insure accuracy. Tests have shown that air conditioner and pitot heat contribute to significant heading errors of the Whiskey Compass. These items should be turned OFF prior to comparing the Whiskey Compass to the PFD heading.

**SECTION 4 - NORMAL PROCEDURES**

**Engine Start - General**

**CAUTION**

Do not attempt flight if there is no indication of alternator output.

**CAUTION**

If a positive oil pressure is not indicated within 30 seconds following an engine start, stop the engine and determine the trouble. In cold weather it will take a few seconds longer to get a positive oil pressure indication.

**NOTE**

Starter manufacturers recommend that starter cranking periods be limited to 30 seconds with a two minute rest period between cranking periods. Longer cranking periods will shorten the life of the starter.

**Before Starting Engine**

Brakes .....	SET
Circuit Breakers.....	Check IN
Carburetor Heat.....	full OFF
Fuel Selector.....	Desired tank
Radios .....	OFF

**SECTION 4 - NORMAL PROCEDURES (continued)**

**Normal Start - Cold Engine**

Throttle ..... $\frac{1}{4}$ " inch open  
Battery Master Switch.....ON  
Primary Flight Display (PFD) .....Verify correct aircraft  
model software  
Alternator Switch .....ON  
Electric Fuel Pump .....ON  
Mixture .....full RICH  
Propeller.....CLEAR  
Starter .....ENGAGE  
Throttle.....ADJUST  
Oil Pressure .....CHECK

| If engine does not start within 10 seconds, prime and repeat starting procedure.

**Normal Start - Hot Engine**

Throttle ..... $\frac{1}{2}$ " inch open  
Battery Master Switch.....ON  
Primary Flight Display (PFD) .....Verify correct aircraft  
model software  
Alternator Switch .....ON  
Electric Fuel Pump .....ON  
Mixture .....full RICH  
Propeller.....CLEAR  
Starter .....ENGAGE  
Throttle.....ADJUST  
Oil Pressure .....CHECK

**SECTION 4 - NORMAL PROCEDURES (continued)****Engine Start When Flooded**

Throttle .....Open full  
Battery Master Switch.....ON  
Primary Flight Display (PFD) .....Verify correct aircraft  
model software  
Alternator Switch .....ON  
Electric Fuel Pump .....OFF  
Mixture .....Idle cut-off  
Propeller.....CLEAR  
Starter .....ENGAGE  
Mixture.....ADVANCE  
Throttle .....RETARD  
Oil Pressure .....CHECK

## SECTION 4 - NORMAL PROCEDURES (continued)

### Starting With External Power Source

#### CAUTION

It is possible to use the ship's battery in parallel by turning only the battery master switch ON. This will give longer cranking capabilities, but will not increase the amperage. Care should be exercised because if the ship's battery has been depleted, the external power supply can be reduced to the level of the ship's battery. This can be tested by turning on the battery master switch momentarily while the starter is engaged. If cranking speed increases, the ship's battery is at a higher level than the external power supply.

#### NOTE

For all normal operations using external power, the battery master and alternator switches should be OFF.

Battery Master Switch.....OFF  
Alternator Switch.....OFF  
All Electrical Equipment.....OFF  
External Power Plug .....Insert in fuselage  
Proceed with normal start checklist, then:  
Throttle .....Lowest possible RPM  
External Power Plug .....Disconnect from fuselage

## SECTION 5 - PERFORMANCE

No change from basic Handbook.

## SECTION 6 - WEIGHT AND BALANCE

No change from basic Handbook.

**SECTION 7 - DESCRIPTION AND OPERATION****A. PFD Systems Description****NOTE**

This supplement provides a general description of the Avidyne FlightMax Entegra Series 700-00006-0XX-( ) PFD, its operation, and aircraft systems interfaces. For a detailed description of PFD operation, refer to the Avidyne FlightMax Entegra Series Primary Flight Display Pilot's Guide, p/n 600-00104-000 revision 00 or appropriate later revision, or 600-00143-000 revision 01 (EXP 5000 R6) or appropriate later revision.

The Entegra PFD start-up is automatic once power is applied. The display presents the Initialization Display immediately after power is applied. Power-on default is 75% brightness. Typical alignment times are 3 minutes once power is applied.

**Attitude Direction Indicator (ADI)**Air Data

The airspeed tape to the left of the main ADI begins indicating at 20 Knots Indicated Airspeed (IAS) and is color coded in accordance with the model POH airspeeds for  $V_{SO}$ ,  $V_{FE}$ ,  $V_s$ ,  $V_{NO}$ , and  $V_{NE}$ . An altitude tape is provided to the right of the main ADI and also displays a symbol for the Altitude Preselect (Altitude Bug). The Vertical Speed Indicator (VSI) is displayed to the right of the altitude tape. For vertical speed rates greater than the PFD displayed VSI scale, the indicator needle will peg just outside the scale and a digital readout of actual VSI up to 4000 FPM is then displayed. An additional data block is provided for display of Outside Air Temperature (OAT), True Airspeed (TAS), and Ground Speed (GS). Controls for selecting bug and barometric correction values are along the right side of the PFD. A wind indicator is also provided beneath the altitude tape.

Attitude Data

Attitude is depicted on the main ADI using a combination of an aircraft reference symbol ("flying-delta") against a background of labeled pitch ladders for pitch and a bank angle pointer in the form of an arced scale along the top of the main ADI for bank. A skid/slip indicator is attached to the bottom edge of the bank angle pointer.

**SECTION 7 - DESCRIPTION AND OPERATION (continued)**

**A. PFD Systems Description (continued)**

**Horizontal Situation Indicator (HSI)**

Heading Data

Magnetic heading is represented in a boxed digital form at the top of the compass rose. Heading rate (Rate of Turn Indicator) takes the form of a blue arcing arrow that begins behind the magnetic heading indicator and moves left or right accordingly. Graduations are provided on the rate of turn indicator scale to indicate ½ and full standard rate turns. A heading bug is also provided on the compass rose.

Navigation Data

Navigation data on the PFD takes several forms. A Course Deviation Indicator (CDI) is always provided on the HSI and a bearing pointer can be optionally selected for display on the HSI by the pilot. Controls for selecting the source of navigation data, selecting the display format of the navigation data, and for selecting the type of compass rose and moving map to be displayed are along the left side of the PFD. The active flight plan contained in the GPS Nav/Comm unit selected as the primary navigation source (Nav) can be optionally selected for display on the HSI as well as the desired range of the optionally selectable moving map display. If a localizer or ILS frequency is tuned and captured in the GPS Nav/Comm selected as the Nav source, a Vertical Deviation Indicator (VDI) and Horizontal Deviation Indicator (HDI) are automatically displayed on the ADI.

While executing an ILS or localizer only approach, the course deviation indicator (CDI) and glideslope needles on the PFD, as appropriate, may exhibit a slight oscillatory motion. The oscillatory motion increases from zero amplitude at approximately 2500 rpm to approximately ½ dot total amplitude at 2700 rpm. The GI-106 mechanical VOR Indicator needles exhibit this same behavior, only to a lesser degree. The pilot should fly the “average” localizer/glideslope needle position or decrease engine rpm to reduce needle oscillation.

**NOTE**

In the event glide slope or localizer signals are lost, the HDI and/or VDI will be displayed as red X's to indicate loss of signal. The red X'd indicator will only be removed if the signal is regained. In this case, the PFD Nav source will set to GPS, or if the GPS Nav/Comm is retuned, to another frequency. Appropriate action must be taken by the pilot if on an approach.



**SECTION 7 - DESCRIPTION AND OPERATION (continued)****A. PFD Systems Description (continued)****Autopilot Integration**

The Entegra PFD is fully integrated with the S-TEC System 55X Autopilot. Reference bugs for Heading, Altitude, and Vertical Speed are provided on the PFD to control the autopilot and aid pilot situational awareness. These bugs are displayed with solid or hollow symbology depending on the autopilot status. If the autopilot is engaged in that mode, the bug is solid to indicate the autopilot is coupled to that bug. A hollow bug indicates the autopilot is not engaged in that mode.

Autopilot mode annunciations are shown on the S-TEC System 55X computer.

When included as part of the installation, autopilot mode annunciations including autopilot ready and fail indications are provided at the top of the PFD screen.

When included as part of the installation, flight director command bars on the PFD attitude indicator can be enabled by the pilot. When the flight director is enabled and the autopilot is engaged in both lateral and vertical modes, the flight director displays the goals of the autopilot.

A lateral autopilot mode must be engaged on the S-TEC System 55X before a vertical mode can be engaged.

The flight director command bars will only be displayed on the PFD when enabled by the pilot and when both lateral and vertical autopilot modes are engaged.

**SECTION 7 - DESCRIPTION AND OPERATION (continued)**

**A. PFD Systems Description (continued)**

**Autopilot Integration (continued)**

The following autopilot modes are supported by the PFD:

1. HDG (Heading, using the heading bug)
2. NAV (Nav, using the course pointer and course deviation indicator)
3. GPSS (GPS Steering, using GPS course guidance)
4. APR (Approach, using the HDI and VDI, including automatic glide slope capture)
5. REV (Reverse sensing HDI approach)
6. ALT (Altitude Hold and Preselect, using the altitude bug)
7. VS (Vertical Speed, using the vertical speed bug)

**NOTE**

When HDG mode is engaged, rotation of the heading bug greater than 180° will result in a reversal of turn direction.

**CAUTION**

If a VLOC is selected in NAV on the PFD and GPSS mode is engaged on the autopilot, the autopilot will track the active flight plan in GPS1 if VLOC1 is selected or GPS2 if VLOC2 is selected and not track VLOC1 or VLOC2 as the selected source in NAV on the PFD. Therefore, the course deviation on the PFD CDI and the course deviation flown by the autopilot can be different. This situation may be confusing and should be avoided.

**Engine Instruments**

The Entegra PFD provides a display of Engine Tachometer (RPM), Oil Pressure (OP), and Fuel Flow (FF) in the upper left hand corner of the display. Tach indications are presented on analog scales with normal operating (green) and warning (red) markings, as appropriate. A digital indication presents fuel flow information in gallons per hour (GPH). A digital indication presents oil pressure information in pounds per square inch (PSI).

**SECTION 7 - DESCRIPTION AND OPERATION (continued)**

**A. PFD Systems Description (continued)**

**Back-up Instruments**

The Entegra PFD system installation includes redundant means of display of certain aircraft flight and systems parameters. Back-up Altimeter, Airspeed and Attitude instruments are provided to facilitate pilot cross-checking of PFD display flight parameters. The aircraft wet compass serves as a back-up heading source.

**THIS SPACE INTENTIONALLY LEFT BLANK**

**SECTION 7 - DESCRIPTION AND OPERATION (continued)**

**B. MFD Systems Description**

**NOTE**

This supplement provides a general description of the Avidyne EX5000 Series 700-00004-0XX-( ) MFD, its operation and aircraft interface. For a detailed description of the MFD, refer to the Avidyne FlightMax EX5000 Series Pilot's Guide and Reference, p/n 600-00105-000 revision 00 or later.

**Navigation**

Data associated with the moving map is found on four pages: Map, Nearest, Trip, and Info pages. The MFD contains a Jeppesen NavData database that is available for display on the Map page. In conjunction with GPS-supplied position information, an own-ship symbol is superimposed on the moving map and positioned relative to the NavData information. GPS can also supply the active flight plan for display on the moving map. Terrain data is provided by a USGS terrain database stored within the MFD and updated only on an as needed basis.

The Jeppesen Navigation Database provides data on airports, approaches, VOR's, NDB's, intersections, airspace definitions, and frequencies. North American and international databases are available. Database information can be updated via the USB port on the front face of the bezel.

The navigation data on the moving map display are based on databases that are updated periodically. Database updates are available on 28-day cycle subscriptions. Expired databases are clearly stated to the pilot via messages during system startup and on the System Setup page. The warning can only be removed by updating the data.

NOAA man-made obstruction database information provides data on man-made obstacles over 200 feet AGL. This data is only available for North America and can be updated via the USB port on the front face of the bezel.

The obstacle data on the moving map display are based on databases that are updated periodically. Database updates are available from Avidyne on 56-day cycle subscriptions. Expired databases are clearly stated to the pilot via messages during system startup and on the System Setup page. The warning can only be removed by updating the data.

**SECTION 7 - DESCRIPTION AND OPERATION (continued)****B. MFD Systems Description (continued)****Navigation (continued)**

Using the Jeppesen NavData data and the GPS-supplied present position, the MFD can provide the pilot with the nearest 25 airports or navaids, depending on pilot selection, within 100 nm. This information is presented on the Nearest page.

More detailed information on a particular airport is also generated from the Jeppesen NavData data and is available for pilot viewing on the Info page.

Flight plan data supplied by the GPS system provide the pilot with a tabular form of the remaining legs in the active GPS flight plan. This information is viewed on the Trip page and includes a CDI for added enroute navigation aiding.

Flight plan data is transmitted to the MFD from an external GPS navigator. Some installations do not support depictions of curved flight paths. In these cases, curved flight path segments will be depicted as straight lines. The GPS navigator and HSI are to be used during approach procedures. Reference the Avidyne FlightMax EX5000 Series Pilot's Guide, p/n 600-00105-000, for more information.

**Datalink**

Datalink information is received by the MFD based upon installation provisions and a subscription service available through Avidyne ([www.myavidyne.com](http://www.myavidyne.com)). Data is presented on the Map, Trip, and Nearest pages. Datalink information is provided for strategic planning purposes only. Data aging and transport considerations make it unsuitable for tactical use. Reference the Avidyne FlightMax EX5000 Series Pilot's Guide, p/n 600-00105-000, for more information.

**Setup**

The various System Setup pages allow the pilot to set user preferences for system operation. In addition to listing the software version identification information and database validity dates, the System Setup page allows access to several pages for preference selection and provides a means to initiate self-tests of the traffic and lightning sensors.

**SECTION 7 - DESCRIPTION AND OPERATION (continued)**

**B. MFD Systems Description (continued)**

**Setup (continued)**

**Airport Settings** page provides selections for displaying airport type, runway surface type and minimum runway lengths on the moving map. **Declutter Settings** page allows the pilot to select settings for defining the base map detail when changing display range. **System Time** page provides an opportunity to select system time zone and Map page menu timeout options. **DataBlock Edit** page allows the pilot to select the data to be displayed in the datablock windows on the Map page. **Datalink Setup** page allows the pilot to select parameters for the datalink system, including update rate and range of weather data request.

**Engine Instruments**

The Engine page provides the pilot with engine parameters depicted on simulated gauges and electrical system parameters located in dedicated regions within the MFD display. An Engine Sensor Unit interfaces with engine-mounted sensors and provides data to the MFD for display.

A leaning function assists the pilot in leaning the engine for best power or best fuel economy. To initiate the leaning function, press the Lean Assist bezel key and proceed to lean the engine fuel mixture. Best economy is achieved when the engine is operating at peak EGT of the leanest cylinder (first cylinder to peak), as recommended by the engine manufacturer. Best power is achieved when the engine is leaned to the first cylinder to reach its EGT peak. When leaning is complete, select Absolute or Normalize to complete the leaning process. A digital readout of EGT change from the peak value is provided for reference. Reference the Avidyne FlightMax EX5000 series Pilot's Guide, p/n 600-00105-000, for more information.

**PILOT'S OPERATING HANDBOOK  
AND  
FAA APPROVED AIRPLANE FLIGHT MANUAL**

**SUPPLEMENT NO. 11  
FOR  
MID-CONTINENT 4300-4XX SERIES  
ELECTRIC ATTITUDE INDICATOR**

This supplement must be attached to the Pilot's Operating Handbook and FAA Approved Airplane Flight Manual when the optional Mid-Continent 4300-4XX Series Electric Attitude Indicator is installed per the Equipment List. The information contained herein supplements or supersedes the basic Pilot's Operating Handbook and FAA Approved Airplane Flight Manual only in those areas listed herein. For limitations, procedures and performance information not contained in this supplement, consult the Pilot's Operating Handbook and FAA Approved Airplane Flight Manual.

FAA APPROVED:



LINDA J. DICKEN  
DOA-510620-CE  
THE NEW PIPER AIRCRAFT, INC.  
VERO BEACH, FLORIDA

DATE OF APPROVAL: OCTOBER 7, 2004

**SECTION 1 - GENERAL**

This supplement supplies information necessary for the operation of the airplane when the optional Mid-Continent model 4300-XXX Electric Attitude Indicator is installed in accordance with FAA Approved Piper data. For additional information refer to the Mid-Continent Instruments Pilot's Guide, manual number 9015834, revision NR, or later revision.

**SECTION 2 - LIMITATIONS**

1. The emergency battery must be checked for proper operation prior to flight.
2. Should the RED TEST annunciator illuminate any time during the self test, this is an indication that the battery pack is in need of charging, or possible replacement. Flight in Instrument Meteorological Conditions (IMC) is prohibited.
3. Internal battery should be used for emergency use only.

**SECTION 3 - EMERGENCY PROCEDURES**

**Loss of Aircraft Electrical System**

Standby (STBY) Power Button.....SELECT

***CAUTION***

The STBY PWR annunciator will rapidly flash for approximately one minute when aircraft power is lost. STBY PWR must be selected, otherwise the gyro will auto shutdown after approximately one minute.

Maintain attitude control using standby gyro.



**SECTION 4 - NORMAL PROCEDURES**

**Preflight Check**

1. Apply aircraft power and allow the gyro to spin up for approximately 2 minutes.
2. Press and hold the STBY PWR button.
3. Verify that after several seconds the amber LED has started to flash. This indicates that the unit has latched into the Battery Test Mode. At this time the STBY PWR button can be released.
4. Verify that a green annunciator is illuminated under the word TEST.
5. Visually monitor the test lights until the amber LED stops flashing, signaling the end of the test.

**NOTE**

A green annunciator throughout the test indicates the standby battery is sufficiently charged and should be able to function under normal operation. The presence of a red annunciator at any time during the test is an indication the standby battery is in need of charging, or possibly replacement.

**NOTE**

The Standby Attitude Indicator will operate for approximately one hour with the internal battery, depending on battery condition at the time of power failure.

**SECTION 5 - PERFORMANCE**

No change.

**SECTION 6 - WEIGHT AND BALANCE**

Factory installed optional equipment is included in the licensed weight and balance data in Section 6 of the Airplane Flight Manual.

**SECTION 7 - DESCRIPTION AND OPERATION**

The Model 4300-4XX Electric Attitude Indicator incorporates a moving display that simulates the earth's horizon and provides the pilot with a real time visual indication of the aircraft pitch and roll attitude relative to the indicator symbolic airplane.

The 4300-4XX Electric Attitude Indicator offers the feature of a self-contained standby power source.

Anytime aircraft power is absent, selecting the STBY PWR button will put the unit into the standby power mode.

A warning circuit monitors the electrical voltage used to power the gyro. When the indicator is turned "OFF", or after the internal battery is discharged, the gyro warning flag comes into view.

**PILOT'S OPERATING HANDBOOK  
AND  
FAA APPROVED AIRPLANE FLIGHT MANUAL**

**SUPPLEMENT NO. 12  
FOR  
S-TEC ADF-650D SYSTEM**

This supplement must be attached to the Pilot's Operating Handbook and FAA Approved Airplane Flight Manual when the S-TEC ADF-650D System is installed per the equipment list. The information contained herein supplements or supersedes the Pilot's Operating Handbook and FAA Approved Airplane Flight Manual only in those areas listed herein. For limitations, procedures, performance and loading information not contained in this supplement, consult the Pilot's Operating Handbook and FAA Approved Airplane Flight Manual.

FAA APPROVED:



LINDA J. DICKEN  
DOA-510620-CE  
THE NEW PIPER AIRCRAFT, INC.  
VERO BEACH, FLORIDA

DATE OF APPROVAL: SEPTEMBER 12, 2005

**SECTION 1 - GENERAL**

This supplement supplies information necessary for the operation of the airplane when the S-TEC ADF-650D System is installed in accordance with FAA approved Piper data.

**SECTION 2 - LIMITATIONS**

No change.

**SECTION 3 - EMERGENCY PROCEDURES**

No change.

**SECTION 4 - NORMAL PROCEDURES**

**To turn on the ADF-650D System:**

- Depress the PWR button momentarily and release.

**NOTE**

If the PWR button is pressed for longer than 3 seconds, the receiver will immediately shut off.

- After successful self test, input desired station frequency and select ANT mode.
- Positively identify selected station or beacon.
- Adjust volume control as required.
- If ADF-650D System is used for navigation, select ADF or BFO mode immediately after the station has been positively identified.

**To turn off the ADF-650D System:**

- Depress the PWR button for at least 3 seconds.

**NOTE**

If the PWR button is released within 3 seconds, normal operations will resume.

**SECTION 4 - NORMAL PROCEDURES (continued)**

**To perform the preflight checklist and self test:**

- After successful self test, press the mode control until ANT is displayed and input a predetermined frequency to select a station in the immediate area. Adjust the volume control as necessary to provide a comfortable listening level.
- Press the ID button and observe that the station identification code becomes louder (if the station is voice-identified, it is not necessary to press the ID button).
- Press the ID button again to cancel the IDENT function and press the mode control until ADF is displayed.
- Observe the IND-650A Indicator and note that the bearing pointer indicates the relative bearing to the station.
- Push the TEST button while observing the indicator bearing pointer. The bearing pointer will rotate 90° and stop.
- Push the TEST button again (to turn off test function). The bearing pointer returns to the original relative bearing position.
- Switch to BFO mode, if appropriate, and verify a tone is present. Select the appropriate operating mode when all checks have been completed.

**SECTION 5 - PERFORMANCE**

No change.

**SECTION 6 - WEIGHT AND BALANCE**

Factory installed optional equipment is included in the licensed weight and balance data in Section 6 of the Pilot's Operating Handbook and Airplane Flight Manual.

**SECTION 7 - DESCRIPTION AND OPERATION**

The S-TEC ADF-650D System operates over a frequency range of 200 through 1799 kHz in 1-kHz increments. Three operating modes are included as part of the ADF-650D System.

- BFO
- ADF
- ANT

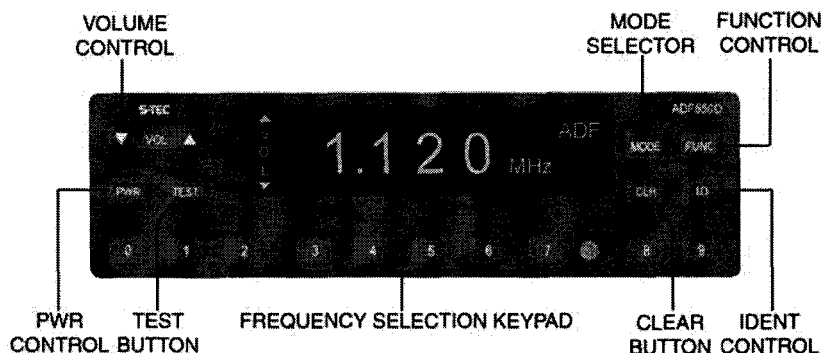

**RCR-650D Receiver Controls**

**Beat Frequency Oscillator (BFO) Mode**

The BFO (beat frequency oscillator) mode is used to aurally identify stations that employ keyed CW (Carrier Wave) rather than amplitude modulation techniques. This mode activates the bearing pointer. The bearing pointer will point in the direction of the station relative to the aircraft heading.

**NOTE**

CW signals (Morse Code) are unmodulated and no audio will be heard without use of BFO. This type of signal is not used in the United States air navigation. It is used in some foreign countries and marine beacons.

**SECTION 7 - DESCRIPTION AND OPERATION (continued)**

**Automatic Direction Finder (ADF) Mode**

The Automatic Direction Finder (ADF) mode uses conventional nondirectional beacons and AM broadcast stations for navigation. This mode activates the bearing pointer. The bearing pointer will point in the direction of the station relative to the aircraft heading.

**Antenna (ANT) Mode**

The ANT (antenna) mode cannot be used for navigation; this mode enhances audio reception clarity and is normally used for station identification.

**Frequency Selection Keypad**

The Frequency Selection Keypad is used to select the system operating frequency. The keypad consists of a row of numbered buttons from 0 to 9, located along the bottom of the RCR-650D Receiver. Frequencies in the megahertz and kilohertz range may be selected.

**Power (PWR) Control**

The power control is used to turn the receiver on and off. Momentarily depressing the PWR button will turn the receiver on and also initiate a self test.

**NOTE**

If the PWR button is pressed for longer than 3 seconds the receiver will immediately shut off.



**SECTION 7 - DESCRIPTION AND OPERATION (continued)**

**Clear (CLR)**

The clear function offers several options for the operator.

- If the entire frequency is entered and the CLR button is pushed, all the numbers will become dashes. An additional push on the CLR button will restore and display the prior frequency entry.
- If an entry is in progress and a number is entered in error, pressing the CLR button will erase the last number entry.
- Pressing the CLR button while in the contrast function reverses the display image and also places the receiver in manual mode.

**NOTE**

It is not necessary to push CLR to enter a new frequency number. Simply complete the entry and then enter the new numbers and they will replace the old frequency.

**Volume (VOL) Control**

The audio volume control is used to adjust the settings and levels for all function selector and setup modes and is controlled by pressing the **▲** and **▼** buttons on the VOL control.

## SECTION 7 - DESCRIPTION AND OPERATION (continued)

### Function (FUNC) Selector

The function selector enables the user to select between contrast and volume display functions (on power-up, the RCR-650D will be in the volume display function). The first time the function selector is pressed, the receiver enters the contrast function. Subsequent presses of the function selector button toggles the unit between contrast and volume. Additionally, pressing the clear button while in the contrast function places the receiver in manual mode. In manual mode, subsequent pushes of the function selector will cycle the receiver through four functions: volume, contrast, display and keypad.

- **Volume**



The volume control function is available on power-up and is accessed immediately by pressing the **▲** and **▼** buttons on the VOL control. Upon activation, the kHz and mode annunciators are temporarily replaced by the text "VOLUME" with a horizontal fill bar. The filled portion of the bar indicates the current volume setting.

- **Contrast**



The contrast function is activated by pressing the FUNC selector. Upon activation, the kHz and mode annunciator are temporarily replaced by the text "CONTRAST" with a horizontal fill bar on the right side of the annunciator panel. The filled portion of the bar indicates the current contrast setting. The contrast is adjusted by pressing the appropriate **▲** and **▼** indicators on the volume control.

- **Display**



When the display is setup in the manual mode, press the FUNC selector until the display function is selected. The display function is then activated and the kHz and mode annunciators are temporarily replaced by the text "DISPLAY" with a horizontal fill bar on the right side of the annunciator panel. The filled portion of the bar indicates the current display setting. The display is adjusted by pressing the appropriate **▲** and **▼** indicators on the volume control.

**SECTION 7 - DESCRIPTION AND OPERATION (continued)****Function (FUNC) Selector - continued**

- **Keypad Light Brightness**



The keypad light brightness setting is used to adjust the brightness of all legends on the display face. When the display is setup in the manual mode, press the FUNC selector until the keypad function is selected. The keypad function is then displayed with the text “KEYPAD” and a horizontal fill bar on the right side of the annunciator panel. The filled portion of the bar indicates the current keypad brightness setting. The brightness is adjusted by pressing the appropriate **▲** and **▼** indicators on the volume control.

**Mode Selector**

The mode selector is used to select one of the three operating states: BFO, ADF, or ANT. Pressing the MODE selector button will step the receiver through the three modes. The current mode will be displayed in the upper right corner of the display. On system power-up, the mode selector will be in the ADF mode.

**Ident (ID)**

The receiver utilizes an Ident Filter for audio output which aids in receiving weak signals. Pressing the ID button toggles the Ident Filter on and off. When the Ident Filter is active, the text “IDENT” is displayed in the bottom right corner of the display.

**SECTION 7 - DESCRIPTION AND OPERATION (continued)**

**Test Mode**



Press the TEST button to start the test mode. The text "TEST" will be displayed in the bottom right corner of the display for approximately 15 seconds. During this time, the IND-650A Indicator pointer will incrementally rotate 90°. Press the TEST button again to cancel the test while in this mode. The pointer will immediately return to its starting point.

**PILOT'S OPERATING HANDBOOK  
AND  
FAA APPROVED AIRPLANE FLIGHT MANUAL**

**SUPPLEMENT NO. 13  
FOR  
AVIDYNE FLIGHTMAX ENTEGRA  
PRIMARY FLIGHT/MULTI-FUNCTION DISPLAYS  
WITH  
THE B&C SPECIALTIES BC410 STANDBY ALTERNATOR**

This supplement must be attached to the Pilot's Operating Handbook and FAA Approved Airplane Flight Manual when the optional Avidyne FlightMax Entegra Primary Flight and Multi-Function Displays with the B&C Specialties BC410 Standby Alternator is installed per the Equipment List. The information contained herein supplements or supersedes the basic Pilot's Operating Handbook and FAA Approved Airplane Flight Manual only in those areas listed herein. For limitations, procedures and performance information not contained in this supplement, consult the Pilot's Operating Handbook and FAA Approved Airplane Flight Manual.

FAA APPROVED:



LINDA J. DICKEN  
DOA-510620-CE  
THE NEW PIPER AIRCRAFT, INC.  
VERO BEACH, FLORIDA

DATE OF APPROVAL: FEBRUARY 7, 2006

ISSUED: JULY 12, 1995  
REVISED: FEBRUARY 7, 2006

REPORT: VB-1610  
1 of 36, 9-103

## SECTION 1 - GENERAL

This airplane is equipped with the Avidyne FlightMax Entegra EXP5000 series 700-00006-0XX-( ) Primary Flight Display with software to the latest revision per Avidyne website and EX5000 series 700-00004-0XX-( ) Multi-Function Display with software to the latest revision per Avidyne website, herein referred to as the "PFD" and "MFD". The PFD is intended to be the primary display of primary flight and essential engine parameter information to the pilot. The PFD is capable of interfacing with a pair of Garmin GNS 430/530's, and an S-TEC System 55X autopilot.

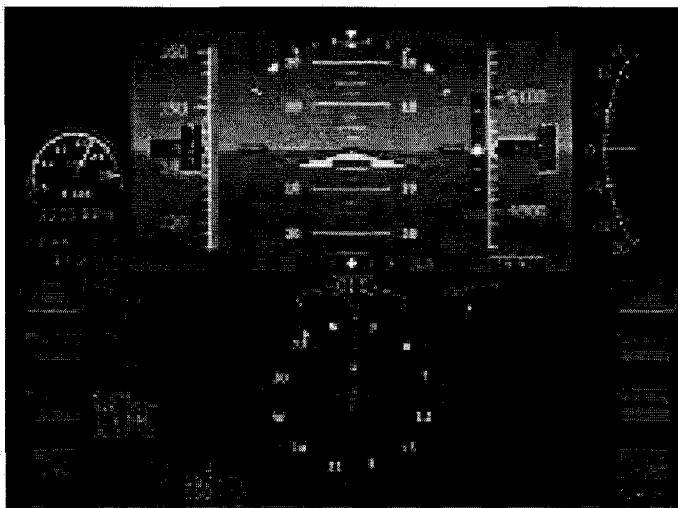

Figure 1 - Entegra 700-00006-0XX-( ) Primary Flight Display

The PFD provides the display of the following aircraft parameters:

- Artificial Horizon
- Airspeed Indication
- Altimeter
- Vertical Speed Indication
- Rate of Turn Indicator
- Skid/Slip Indicator
- Horizontal Situation Indication
- RMI
- Course Deviation Indication
- Outside Air Temperature
- Engine RPM
- Fuel Flow
- Oil Pressure
- Autopilot Annunciation

**SECTION 1 - GENERAL (continued)**

The MFD is intended to be a supplemental display of situational and navigation information to the pilot. Its primary function is to provide a moving map display to the pilot for increased situational awareness. The MFD is capable of accepting data from a variety of GPS sensors, the BFG WX-500 Stormscope passive thunderstorm detection unit, Engine Sensor Unit, and either the L3 Skywatch Traffic Advisory System (TAS), Bendix/King TAS, or the Ryan Traffic and Collision Alert Device (TCAD) system. The unit is organized around logical groupings of information presented on "Pages".

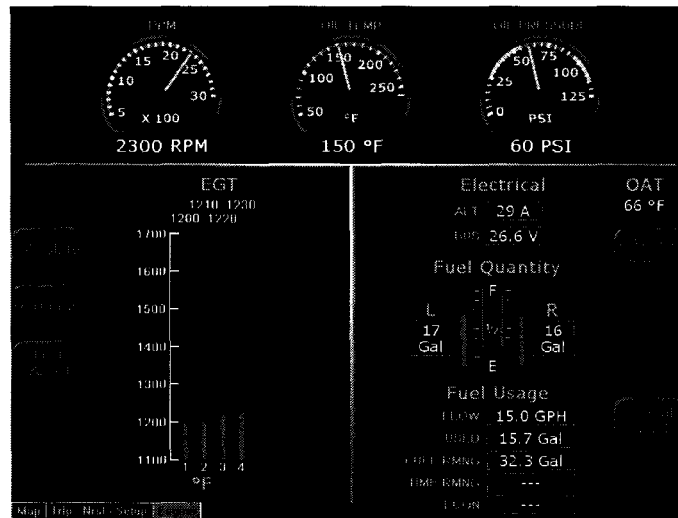

Figure 2 - EX5000 series 700-00004-0XX-( ) Multi-Function Display

The MFD provides the display of the following aircraft parameters:

- Engine RPM
- Engine Oil Temperature
- Engine Oil Pressure
- EGT
- Cylinder Head Temperature
- Aircraft Electrical Status
- Outside Air Temperature
- Fuel Quantity
- Fuel Usage Data

**SECTION 1 - GENERAL (continued)**

A B&C Specialties, BC410 standby alternator, when ON, will automatically activate in the event of a failure in the primary alternator, therefore replacing the primary alternator function, but not supplementing its output. The alternator is gear driven through the engine vacuum pump drive pad.

The standby alternator is rated for 20 amperes of maximum load. The actual load available for use is dependent on engine rpm and current operating conditions.



**SECTION 2 - LIMITATIONS****A. PFD Limitations**

1. IFR flight is prohibited when the PFD or any standby instrument is inoperative (altimeter, airspeed indicator, artificial horizon, or whiskey compass).
2. IFR flight is prohibited upon aircraft total loss of essential engine parameter display (manifold pressure, tachometer, fuel flow).
3. The Avidyne FlightMax Entegra series Primary Flight Display Pilot's Guide, p/n 600-00104-000 revision 00 or appropriate later revision, or p/n 600-00143-000 revision 01 (EXP 5000 R6) or appropriate later revision, must be available to the pilot during all flight operations.
4. If a VOR or Localizer (VLOC) navigation source is displayed on the HSI and GPSS mode is engaged on the autopilot, the autopilot will track the active flight plan in the GPS corresponding to the selected VLOC source selected for display on the HSI (i.e. GPS1 for VLOC1 or GPS2 for VLOC2). This configuration is potentially confusing and must be avoided.
5. GPSS mode must not be used on the final approach segment of a VLOC approach (ILS, LOC or non-GPS-overlay VOR). GPSS mode must be deselected (i.e., NAV mode selected) prior to the turn onto the final approach course.

**NOTE**

The PFD integrates with separately approved sensor and flight control installations. Adherence to limitations in appropriate installation AFM supplements is mandatory.

**B. MFD Limitations**

1. The Avidyne moving map display provides visual advisory of the airplane's GPS position against a moving map. This information supplements CDI course deviation and information presented on the GPS navigator. The moving map display must not be used as the primary navigation instrument.
2. Use of Map page during IFR flight requires an IFR approved GPS receiver and installation, operated in accordance with its applicable limitations.
3. The Avidyne FlightMax EX-series Pilot's Guide, p/n 600-00105-000 revision 00 or appropriate later revision, must be available to the pilot during all flight operations.

---

**SECTION 2 - LIMITATIONS (continued)**

**B. MFD Limitations (continued)**

4. Aircraft dispatch is prohibited when the MFD is inoperative.
5. Selecting "Lightning Display OFF" for the Lightning overlay of the Map page will prevent current heading values from being sent to the WX500 sensor from the EX5000.

When "Lightning Display OFF" is selected the EX5000 will stop sending current heading values to the WX500. When this selection is made, the WX500 will still use the last heading value that was present before this selection even though the actual aircraft heading may have changed since that selection was made.

Consequently, the Stormscope heading information provided to the Garmin 430 by the EX5000 will not be updated, resulting in an inaccurate lightning depiction on the Garmin 430. This issue does not affect the lightning display on the EX5000.

To avoid this invalid condition, **disable the WX500 on the GNS430**. For instructions on how to accomplish this, refer to the Garmin 400 Series Installation Manual, p/n 190-00140-02, latest revision (reference Section 5.1 Configuration Mode Operations, Section 5.2 Installation Configuration pages, and Section 5.2.2 Main RS232 Configuration page).

**CAUTION**

Traffic information shown on the Map page display is provided to the pilot as an aid to visually acquiring traffic. Pilot's should maneuver their aircraft based only on ATC guidance or positive visual acquisition of the conflicting traffic. Maneuvers should be consistent with ATC instructions. No maneuvers should be based only on a Traffic Advisory.

Terrain information shown on the Map page display is provided to the pilot as an aid to situational awareness. The Map page terrain color representations should not be used as a basis for terrain avoidance.

**NOTE**

The MFD integrates with separately approved sensor and flight control installations. Adherence to limitations in appropriate installation AFM supplements is mandatory.

**SECTION 2 - LIMITATIONS (continued)**

**C. CMAX CHART PAGE Limitations**

The geographic referenced aircraft symbol must not be used for navigation.

**NOTE**

The aircraft symbol displayed provides supplemental aircraft situational awareness information. It is not intended as a means for navigation or flight guidance. The airplane symbol is not to be used for conducting instrument approaches or departures. Position accuracy, orientation, and related guidance must be assumed by other means or required navigation.

Operators with the optional CMax Chart Page must have back-up charts available. Do not rely upon CMax charts as your sole source of navigation information.

**D. STANDBY ALTERNATOR Limitations**

The standby alternator system is used in the event of primary alternator failure and not for normal operations.

The standby alternator is limited to 20 amperes continuous output. Transient operations of greater than 20 amperes for no more than 5 consecutive minutes may be conducted.

**NOTE**

Certain flight maneuvers such as climbs and lower power settings will result in an engine RPM less than 2500. Flight conditions resulting in less than 2500 engine RPM will reduce the standby alternator system capability and possibly require load shedding to maintain a system voltage above 25 volts.

**SECTION 3 - EMERGENCY PROCEDURES**

**Failure of Pilot's Electronic Attitude Direction Display Screen (PFD)**

**Indication: PFD Display goes blank.**

Standby Attitude Gyro .....VERIFY ON and  
flag is pulled on gyro

Maintain attitude control using standby gyro and establish the aircraft in straight  
and level unaccelerated flight.

**If time and conditions permit:**

PFD Brightness Control (BRT/DIM) .....Run to full bright  
PFD Circuit Breaker .....PULL and RESET

*If PFD Screen cannot be reinstated:*

On aircraft equipped with the optional second Nav Indicator (OBS):

Mechanical Nav Indicator (OBS).....Utilize for primary navigation

Engine Instruments.....Refer to Engine page of MFD

**NOTE**

The Mechanical Nav Indicator (OBS) receives nav  
information directly from the No. 2 nav/com/GPS. Only  
VLOC information is available.

Maintain attitude, airspeed and heading control using standby instruments,  
magnetic compass and other directional indications (such as MFD, MAP/NAV  
page).

**CAUTION**

High current loads in the vicinity of the magnetic compass  
can influence its accuracy. Depending on the flight conditions,  
the pilot must reduce these loads as much as possible to  
insure accuracy. Tests have shown that air conditioner and  
pitot heat contribute to significant heading errors of the  
magnetic compass. These items should be turned OFF prior  
to comparing magnetic compass headings.

*Land as soon as practical.*

**SECTION 3 - EMERGENCY PROCEDURES (continued)****Loss of PFD Engine Data**

**Indication: Indicator needle removed from dial and digital readout replaced with white dashes.**

Engine Instruments.....Refer to Engine page of MFD  
*Land as soon as practical.*

**Invalid Air Data**

**Indication: Airspeed, Altimeter, and Vertical Speed data replaced with Red X's.**

Maintain aircraft airspeed and altitude by referring to the standby airspeed and altimeter.

**If time and conditions permit:**

PFD Circuit Breaker .....PULL and RESET

**If air data is still invalid:**

Refer to standby airspeed indicator and altimeter.

*Land as soon as practical.*

**Invalid Heading Data**

**Indication: Heading Bug and Heading Data removed and replaced with Red X's.**

**If time and conditions permit:**

PFD Circuit Breaker .....PULL and RESET

Maintain heading control using magnetic compass and other directional indications (such as MFD, MAP/NAV page).

**CAUTION**

High current loads in the vicinity of the magnetic compass can influence its accuracy. Depending on the flight conditions, the pilot must reduce these loads as much as possible to insure accuracy. Tests have shown that air conditioner and pitot heat contribute to significant heading errors of the magnetic compass. These items should be turned OFF prior to comparing magnetic compass headings.

*Land as soon as practical.*

**SECTION 3 - EMERGENCY PROCEDURES (continued)**

**Invalid Attitude and Heading Data**

**Indication: Attitude and Heading Data removed and replaced with Red X's.**

Standby Attitude Gyro .....VERIFY ON and  
flag is pulled on gyro.

Maintain attitude control using standby gyro.

**If time and conditions permit:**

PFD Circuit Breaker .....PULL and RESET

**If attitude and heading data is still invalid:**

Maintain attitude control by using standby gyro.

Maintain heading control by utilizing magnetic compass and other directional indications (such as MFD, MAP/NAV page).

**CAUTION**

High current loads in the vicinity of the magnetic compass can influence its accuracy. Depending on the flight conditions, the pilot must reduce these loads as much as possible to insure accuracy. Tests have shown that air conditioner and pitot heat contribute to significant heading errors of the magnetic compass. These items should be turned OFF prior to comparing magnetic compass headings.

***Land as soon as practical.***

**SECTION 3 - EMERGENCY PROCEDURES (continued)****Failure of Attitude, Airspeed and Heading Reference System (ADAHRS)****Indication: Airspeed, Attitude, Heading and Altitude replaced with Red X's.**Standby Attitude Gyro .....VERIFY ON and  
flag is pulled on gyro

Maintain attitude control using standby gyro.

**If time and conditions permit:**

PFD Circuit Breaker .....PULL and RESET

*If ADAHRS initialization does not occur:*

On aircraft equipped with the optional second Nav Indicator (OBS):

Mechanical Nav Indicator (OBS).....Utilize for primary navigation

Engine Instruments.....Refer to Engine page of MFD

**NOTE**

The Mechanical Nav Indicator (OBS) receives nav information directly from the No. 2 nav/com/GPS. Only VLOC information is available.

Maintain attitude, airspeed and heading control using standby instruments, magnetic compass and other directional indications (such as MFD, MAP/NAV page).

**CAUTION**

High current loads in the vicinity of the magnetic compass can influence its accuracy. Depending on the flight conditions, the pilot must reduce these loads as much as possible to insure accuracy. Tests have shown that air conditioner and pitot heat contribute to significant heading errors of the magnetic compass. These items should be turned OFF prior to comparing magnetic compass headings.

*Land as soon as practical.*

**SECTION 3 - EMERGENCY PROCEDURES (continued)**

**Cross Check Monitor**

**Indication: Yellow Crosscheck Attitude Annunciator on PFD.**

Establish aircraft in straight and level unaccelerated flight.

Aircraft Attitude .....Crosscheck aircraft attitude  
with standby attitude gyro

**Total Loss of Engine Instruments**

**Indication: Indicator needle removed from dial and digital readout replaced with white dashes.**

DAU Circuit Breaker .....PULL and RESET

**If engine data is still invalid:**

**NOTE**

The following engine messages will be displayed on the MFD if an exceedance is detected:

- Check Oil Temp
- Check Oil Press
- Check CHT
- Check RPM
- Check EGT

*If failure occurs during takeoff:*

Mixture .....Maintain full rich  
Throttle .....Full power

***Return to airport for landing.***

*If failure occurs during climb or landing:*

Mixture .....Maintain full rich  
Throttle.....As required

***Land as soon as practical.***

*If failure occurs after setting cruise power and mixture:*

Power .....Maintain power setting

***Land as soon as practical.***

*If failure occurs prior to or during descent:*

Mixture .....Full rich  
Throttle .....Set for 500 feet per minute  
descent at 126 KIAS



**SECTION 3 - EMERGENCY PROCEDURES (continued)****ALTERNATOR FAILURE****Failure of Primary Alternator**

**Indication: Alternator Inop annunciator light illuminated and Standby Alternator ON annunciator light illuminated or zero current displayed on MFD alternator indication source.**

**NOTE**

Anytime the bus voltage is below 25 Vdc, the Low Bus Voltage annunciator will be illuminated.

STBY ALTR .....Verify ON/check ammeter indication  
 Engine RPM .....Increase to a minimum of 2500  
 Electrical Load .....Reduce until total load is below 20 amps  
 and/or low bus annunciator is extinguished

**NOTE**

If the STBY ALTR ON annunciator is flashing then reduce electrical loads until the annunciator no longer flashes.

**NOTE**

Certain flight maneuvers such as climbs and lower power settings will result in an engine RPM less than 2500. Flight conditions resulting in less than 2500 engine RPM will reduce the standby alternator system capability and possibly require load shedding to maintain a system voltage above 25 volts.

ALTR .....OFF  
 ALTR FIELD circuit breaker .....check and reset as required  
 ALTR .....ON

**If primary alternator power not restored:**

ALTR .....OFF

If primary alternator output cannot be restored, maintain an electrical load of less than 20 amps with which the STBY ALTR ON annunciator no longer flashes and *land as soon as practical.*

**SECTION 3 - EMERGENCY PROCEDURES (continued)**

**ALTERNATOR FAILURE (continued)**

**Failure of Standby Alternator**

If STBY ALTR ON is not illuminated:

STBY ALTR .....OFF  
STBY ALTR FIELD circuit breaker .....check and reset as required  
STBY ALTR SENSE circuit breaker .....check and reset as required  
STBY ALTR .....ON

**If standby alternator power not restored:**

STBY ALTR .....OFF

If the standby alternator has failed or cannot provide adequate power, then electrical power is dependent on available battery storage. Duration of battery power available will be dependent on electrical load and battery condition prior to failure. Execute Complete Electrical Failure checklist when battery is depleted. *Land as soon as possible.*

**WARNING**

Compass error may exceed 10 degrees with alternator inoperative.

**CAUTION**

Any power interruption will result in loss of attitude information from the PFD until the unit can be reinstated on the ground.

**NOTE**

LO BUS VOLTAGE annunciator will be illuminated. Anticipate complete electrical failure. Duration of battery power available will be dependent on electrical load and battery condition prior to failure.

**SECTION 3 - EMERGENCY PROCEDURES (continued)**  
**ALTERNATOR FAILURE (continued)**

Reduce electrical loads by switching OFF or pulling circuit breakers for all non-essential equipment to include the following:

- Reduce PFD and MFD brightness as part of overall electrical system management
- Pitot heat (unless required)
- Airconditioner and ventilation fan (if installed)
- Landing light (use sparingly)
- Strobe lights
- Nav lights
- Recognition lights (if equipped)
- Cabin/flood lights
- No. 2 nav/com/GPS
- Autopilot (if equipped)
- Electric trim (if equipped)
- DME (unless required for published approach)
- Stormscope (if equipped)
- Skywatch (if equipped)

***Land as soon as possible.***

**SECTION 3 - EMERGENCY PROCEDURES (continued)**

**Electrical Overload (Alternator over 20 amps above known electrical load)**

ALTR.....ON  
BATT MASTR .....OFF

**If alternator loads are reduced:**

Electrical load .....reduce to minimum

**NOTE**

Due to increased system voltage and radio frequency noise, operation with ALTR switch ON and BATT MASTR switch OFF should be made only when required by an electrical system failure.

**If alternator loads are not reduced:**

BATT.....ON  
ALT .....OFF  
STBY ALTR .....verify ON/check ammeter indication

**NOTE**

If the STBY ALTR ON annunciator is flashing then reduce electrical loads until the annunciator no longer flashes.

If the standby alternator has failed or cannot provide adequate power, then electrical power is dependent on available battery storage. Duration of battery power available will be dependent on electrical load and battery condition prior to failure. Execute **Complete Electrical Failure** checklist when battery is depleted.

**WARNING**

Compass error may exceed 10 degrees with alternator inoperative.

**CAUTION**

Any power interruption will result in loss of attitude information from the PFD until the unit can be reinstated on the ground.

**NOTE**

LO BUS VOLTAGE annunciator will be illuminated. Anticipate complete electrical failure. Duration of battery power available will be dependent on electrical load and battery condition prior to failure.

**SECTION 3 - EMERGENCY PROCEDURES (continued)**

Reduce electrical loads by switching OFF or pulling circuit breakers for all non-essential equipment to include the following:

- Reduce PFD and MFD brightness as part of overall electrical system management
- Pitot heat (unless required)
- Airconditioner and ventilation fan (if installed)
- Landing light (use sparingly)
- Strobe lights
- Nav lights
- Recognition lights (if equipped)
- Cabin/flood lights
- No. 2 nav/com/GPS
- Autopilot (if equipped)
- Electric trim (if equipped)
- DME (unless required for published approach)
- Stormscope (if equipped)
- Skywatch (if equipped)

***Land as soon as practical.***

**SECTION 3 - EMERGENCY PROCEDURES (continued)**

**Complete Electrical Failure**

Standby Attitude Gyro .....SELECT Standby (STBY) power button

**CAUTION**

The STBY PWR annunciator will rapidly flash for approximately one minute when aircraft power is lost. STBY PWR must be selected, otherwise the gyro will auto shutdown after approximately one minute.

Standby Attitude Gyro .....VERIFY ON and  
flag is pulled on gyro

Maintain aircraft control with reference to the standby airspeed, altimeter, and attitude gyro indicators.

Battery Switch .....OFF

Ground Clearance Switch (if installed) .....ON

**Prior to descent:**

Mixture .....FULL RICH

Throttle .....Set for approx. 500 feet per  
minute descent at 126 KIAS

*Land as soon as possible.*

**WARNING**

Compass error may exceed 10 degrees with alternator inoperative.

**NOTE**

Turning ON the ground clearance switch will activate the No. 1 nav/com/GPS radio.

**SECTION 3 - EMERGENCY PROCEDURES (continued)****Fire in Flight****Electrical Fire**

Fire.....Extinguish  
 Battery Master Switch.....OFF  
 ALTR Switch.....OFF  
 STBY ALTR Switch .....OFF  
 Standby Attitude Gyro.....SELECT Standby (STBY) power button

**CAUTION**

The STBY PWR annunciator will rapidly flash for approximately one minute when aircraft power is lost. STBY PWR must be selected, otherwise the gyro will auto shutdown after approximately one minute.

Standby Attitude Gyro .....VERIFY ON and  
 flag is pulled on gyro

Maintain aircraft control with reference to the standby airspeed, altimeter, and attitude gyro indicators.

Ground Clearance Switch (if installed) .....ON

**NOTE**

Turning ON the ground clearance switch will activate the No. 1 nav/com/GPS radio.

Vents .....OPEN  
 Cabin Heat.....OFF

**Prior to descent:**

Mixture.....FULL RICH  
 Throttle .....Set for approx. 500 feet per  
 minute descent at 126 KIAS

*Land as soon as practical.*

**WARNING**

Compass error may exceed 10 degrees with alternator inoperative.

**SECTION 3 - EMERGENCY PROCEDURES (continued)**

**Aircraft Engine Power Loss**

During an engine failure the pilot may elect to attempt an engine restart. During this time large voltage drops may cause the PFD to lose power and reinitialize. During this initialization process the PFD may not be able to complete a fast alignment during flight and therefore the pilot may have to obtain aircraft attitude and aircraft control using the standby instruments.

- Refer to the Emergency Section of the Pilot's Operating Handbook.
- If the PFD is able to perform fast alignment, when prompted by the PFD:
  - Maintain straight and level flight
- OR**
- If engine does not restart, maintain wings level and appropriate aircraft speed.
- Press the fast erect button.
- If the PFD was not able to perform fast alignment, maintain aircraft control with reference to the standby instruments for aircraft attitude information.

**CAUTION**

In case of engine failure, minimize the use of the starter and turn off all non-essential electrical equipment to preserve battery capacity.

**NOTE**

If standby alternator is installed, select OFF when primary alternator is OFF.

**Loss of Fuel Flow**

Electric Fuel Pump .....ON  
Fuel Selector .....Check on tank containing usable fuel

**Engine Driven Fuel Pump Failure**

Throttle .....RETARD  
Electric Fuel Pump .....ON  
Throttle.....RESET as required

**CAUTION**

If normal engine operation and fuel flow is not immediately re-established, the electric fuel pump should be turned OFF. The lack of fuel flow indication while the electric pump is on could indicate a leak in the fuel system or fuel exhaustion. If fuel system leak is verified, switch fuel selector to OFF.



**SECTION 3 - EMERGENCY PROCEDURES (continued)****Loss of Heading Accuracy**

## Indication:

- Difficulty maintaining course while using VOR or GPS.
- Excessive difference between heading and track required maintaining a VOR or GPS course.
- ATC indicates the aircraft is on a wrong heading.
- Excessive deviation between PFD heading and magnetic compass. (>10° after compass deviation applied.)

If heading systems differ by more than 10° (after compass deviation applied):

- Use magnetic compass for primary heading reference.

***CAUTION***

High current loads in the vicinity of the magnetic compass can influence its accuracy. Depending on the flight conditions, the pilot must reduce these loads as much as possible to insure accuracy. Tests have shown that air conditioner and pitot heat contribute to significant heading errors of the magnetic compass. These items should be turned OFF prior to comparing the magnetic compass to the PFD heading.

**SECTION 4 - NORMAL PROCEDURES**

**Engine Start - General**

**CAUTION**

Do not attempt flight if there is no indication of primary alternator output.

**CAUTION**

If a positive oil pressure is not indicated within 30 seconds following an engine start, stop the engine and determine the trouble. In cold weather it will take a few seconds longer to get a positive oil pressure indication.

**NOTE**

Starter manufacturers recommend that starter cranking periods be limited to 30 seconds with a two minute rest period between cranking periods. Longer cranking periods will shorten the life of the starter.

**Before Starting Engine**

Brakes .....	SET
Circuit Breakers.....	Check IN
Carburetor Heat.....	full OFF
Fuel Selector.....	Desired tank
Radios .....	OFF



**SECTION 4 - NORMAL PROCEDURES (continued)**

**Engine Start When Flooded**

Throttle .....Open full  
Battery Master Switch.....ON  
Primary Flight Display (PFD) .....Verify correct aircraft  
model software  
Alternator Switch .....ON  
Standby Alternator Switch .....ON  
Electric Fuel Pump .....OFF  
Mixture .....Idle cut-off  
Propeller.....CLEAR  
Starter .....ENGAGE  
Mixture.....ADVANCE  
Throttle .....RETARD  
Oil Pressure .....CHECK

**SECTION 4 - NORMAL PROCEDURES (continued)****Starting With External Power Source****CAUTION**

It is possible to use the ship's battery in parallel by turning only the battery master switch ON. This will give longer cranking capabilities, but will not increase the amperage. Care should be exercised because if the ship's battery has been depleted, the external power supply can be reduced to the level of the ship's battery. This can be tested by turning on the battery master switch momentarily while the starter is engaged. If cranking speed increases, the ship's battery is at a higher level than the external power supply.

**NOTE**

For all normal operations using external power, the battery master and alternator switches should be OFF.

Battery Master Switch .....	OFF
Alternator Switch.....	OFF
Standby Alternator Switch.....	OFF
All Electrical Equipment .....	OFF
External Power Plug .....	Insert in fuselage
Proceed with normal start checklist, then:	
Throttle .....	Lowest possible RPM
External Power Plug .....	Disconnect from fuselage

**SECTION 5 - PERFORMANCE**

No change from basic Handbook.

**SECTION 6 - WEIGHT AND BALANCE**

No change from basic Handbook.

**SECTION 4 - NORMAL PROCEDURES (continued)**

**Ground Check**

Throttle.....maximum power/RPM  
ALTR switch .....OFF  
STBY ALTR ON annunciator .....verify ON  
Increase electrical load to over 20 amps.  
STBY ALTR ON annunciator .....verify flashing  
Decrease electrical load to less than 20 amps.  
STBY ALTR ON annunciator .....verify ON (steady)  
Throttle .....retard  
ALTR switch .....ON  
Verify normal amperage indication.  
STBY ALTR ON annunciator .....verify extinguished

**Before Takeoff**

STBY ALTR switch .....verify ON

**Stopping Engine**

STBY ALTR switch .....OFF

**SECTION 5 - PERFORMANCE**

No change from basic Handbook.

**SECTION 6 - WEIGHT AND BALANCE**

No change from basic Handbook.

**SECTION 7 - DESCRIPTION AND OPERATION****A. PFD Systems Description****NOTE**

This supplement provides a general description of the Avidyne FlightMax Entegra Series 700-00006-0XX-( ) PFD, its operation, and aircraft systems interfaces. For a detailed description of PFD operation, refer to the Avidyne FlightMax Entegra Series Primary Flight Display Pilot's Guide, p/n 600-00104-000 revision 00 or appropriate later revision, or 600-00143-000 revision 01 (EXP 5000 R6) or appropriate later revision.

The Entegra PFD start-up is automatic once power is applied. The display presents the Initialization Display immediately after power is applied. Power-on default is 75% brightness. Typical alignment times are 3 minutes once power is applied.

**Attitude Direction Indicator (ADI)**Air Data

The airspeed tape to the left of the main ADI begins indicating at 20 Knots Indicated Airspeed (IAS) and is color coded in accordance with the model POH airspeeds for  $V_{SO}$ ,  $V_{FE}$ ,  $V_S$ ,  $V_{NO}$ , and  $V_{NE}$ . An altitude tape is provided to the right of the main ADI and also displays a symbol for the Altitude Preselect (Altitude Bug). The Vertical Speed Indicator (VSI) is displayed to the right of the altitude tape. For vertical speed rates greater than the PFD displayed VSI scale, the indicator needle will peg just outside the scale and a digital readout of actual VSI up to 4000 FPM is then displayed. An additional data block is provided for display of Outside Air Temperature (OAT), True Airspeed (TAS), and Ground Speed (GS). Controls for selecting bug and barometric correction values are along the right side of the PFD. A wind indicator is also provided beneath the altitude tape.

Attitude Data

Attitude is depicted on the main ADI using a combination of an aircraft reference symbol ("flying-delta") against a background of labeled pitch ladders for pitch and a bank angle pointer in the form of an arced scale along the top of the main ADI for bank. A skid/slip indicator is attached to the bottom edge of the bank angle pointer.

**SECTION 7 - DESCRIPTION AND OPERATION (continued)**

**A. PFD Systems Description (continued)**

**Horizontal Situation Indicator (HSI)**

Heading Data

Magnetic heading is represented in a boxed digital form at the top of the compass rose. Heading rate (Rate of Turn Indicator) takes the form of a blue arcing arrow that begins behind the magnetic heading indicator and moves left or right accordingly. Graduations are provided on the rate of turn indicator scale to indicate ½ and full standard rate turns. A heading bug is also provided on the compass rose.

Navigation Data

Navigation data on the PFD takes several forms. A Course Deviation Indicator (CDI) is always provided on the HSI and a bearing pointer can be optionally selected for display on the HSI by the pilot. Controls for selecting the source of navigation data, selecting the display format of the navigation data, and for selecting the type of compass rose and moving map to be displayed are along the left side of the PFD. The active flight plan contained in the GPS Nav/Comm unit selected as the primary navigation source (Nav) can be optionally selected for display on the HSI as well as the desired range of the optionally selectable moving map display. If a localizer or ILS frequency is tuned and captured in the GPS Nav/Comm selected as the Nav source, a Vertical Deviation Indicator (VDI) and Horizontal Deviation Indicator (HDI) are automatically displayed on the ADI.

While executing an ILS or localizer only approach, the course deviation indicator (CDI) and glideslope needles on the PFD, as appropriate, may exhibit a slight oscillatory motion. The oscillatory motion increases from zero amplitude at approximately 2500 rpm to approximately ½ dot total amplitude at 2700 rpm. The GI-106 mechanical VOR Indicator needles exhibit this same behavior, only to a lesser degree. The pilot should fly the “average” localizer/glideslope needle position or decrease engine rpm to reduce needle oscillation.

**NOTE**

In the event glide slope or localizer signals are lost, the HDI and/or VDI will be displayed as red X's to indicate loss of signal. The red X'd indicator will only be removed if the signal is regained. In this case, the PFD Nav source will set to GPS, or if the GPS Nav/Comm is retuned, to another frequency. Appropriate action must be taken by the pilot if on an approach.



**SECTION 7 - DESCRIPTION AND OPERATION (continued)**

**A. PFD Systems Description (continued)**

**Autopilot Integration**

The Entegra PFD is fully integrated with the S-TEC System 55X Autopilot. Reference bugs for Heading, Altitude, and Vertical Speed are provided on the PFD to control the autopilot and aid pilot situational awareness. These bugs are displayed with solid or hollow symbology depending on the autopilot status. If the autopilot is engaged in that mode, the bug is solid to indicate the autopilot is coupled to that bug. A hollow bug indicates the autopilot is not engaged in that mode.

Autopilot mode annunciations are shown on the S-TEC System 55X computer. When included as part of the installation, autopilot mode annunciations including autopilot ready and fail indications are provided at the top of the PFD screen.

When included as part of the installation, flight director command bars on the PFD attitude indicator can be enabled by the pilot. When the flight director is enabled and the autopilot is engaged in both lateral and vertical modes, the flight director displays the goals of the autopilot.

A lateral autopilot mode must be engaged on the S-TEC System 55X before a vertical mode can be engaged.

The flight director command bars will only be displayed on the PFD when enabled by the pilot and when both lateral and vertical autopilot modes are engaged.

**SECTION 7 - DESCRIPTION AND OPERATION (continued)**

**A. PFD Systems Description (continued)**

**Autopilot Integration (continued)**

The following autopilot modes are supported by the PFD:

1. HDG (Heading, using the heading bug)
2. NAV (Nav, using the course pointer and course deviation indicator)
3. GPSS (GPS Steering, using GPS course guidance)
4. APR (Approach, using the HDI and VDI, including automatic glide slope capture)
5. REV (Reverse sensing HDI approach)
6. ALT (Altitude Hold and Preselect, using the altitude bug)
7. VS (Vertical Speed, using the vertical speed bug)

**NOTE**

When HDG mode is engaged, rotation of the heading bug greater than 180° will result in a reversal of turn direction.

**CAUTION**

If a VLOC is selected in NAV on the PFD and GPSS mode is engaged on the autopilot, the autopilot will track the active flight plan in GPS1 if VLOC1 is selected or GPS2 if VLOC2 is selected and not track VLOC1 or VLOC2 as the selected source in NAV on the PFD. Therefore, the course deviation on the PFD CDI and the course deviation flown by the autopilot can be different. This situation may be confusing and should be avoided.

**Engine Instruments**

The Entegra PFD provides a display of Engine Tachometer (RPM), Oil Pressure (OP), and Fuel Flow (FF) in the upper left hand corner of the display. Tach indications are presented on analog scales with normal operating (green) and warning (red) markings, as appropriate. A digital indication presents fuel flow information in gallons per hour (GPH). A digital indication presents oil pressure information in pounds per square inch (PSI).

**SECTION 7 - DESCRIPTION AND OPERATION (continued)**

**A. PFD Systems Description (continued)**

**Back-up Instruments**

The Entegra PFD system installation includes redundant means of display of certain aircraft flight and systems parameters. Back-up Altimeter, Airspeed and Attitude instruments are provided to facilitate pilot cross-checking of PFD display flight parameters. The aircraft magnetic compass serves as a back-up heading source.

**THIS SPACE INTENTIONALLY LEFT BLANK**

**SECTION 7 - DESCRIPTION AND OPERATION (continued)**

**B. MFD Systems Description**

**NOTE**

This supplement provides a general description of the Avidyne EX5000 Series 700-00004-0XX-( ) MFD, its operation and aircraft interface. For a detailed description of the MFD, refer to the Avidyne FlightMax EX5000 Series Pilot's Guide and Reference, p/n 600-00105-000 revision 00 or later.

**Navigation**

Data associated with the moving map is found on four pages: Map, Nearest, Trip, and Info pages. The MFD contains a Jeppesen NavData database that is available for display on the Map page. In conjunction with GPS-supplied position information, an own-ship symbol is superimposed on the moving map and positioned relative to the NavData information. GPS can also supply the active flight plan for display on the moving map. Terrain data is provided by a USGS terrain database stored within the MFD and updated only on an as needed basis.

The Jeppesen Navigation Database provides data on airports, approaches, VOR's, NDB's, intersections, airspace definitions, and frequencies. North American and international databases are available. Database information can be updated via the USB port on the front face of the bezel.

The navigation data on the moving map display are based on databases that are updated periodically. Database updates are available on 28-day cycle subscriptions. Expired databases are clearly stated to the pilot via messages during system startup and on the System Setup page. The warning can only be removed by updating the data.

NOAA man-made obstruction database information provides data on man-made obstacles over 200 feet AGL. This data is only available for North America and can be updated via the USB port on the front face of the bezel.

The obstacle data on the moving map display are based on databases that are updated periodically. Database updates are available from Avidyne on 56-day cycle subscriptions. Expired databases are clearly stated to the pilot via messages during system startup and on the System Setup page. The warning can only be removed by updating the data.

**SECTION 7 - DESCRIPTION AND OPERATION (continued)****B. MFD Systems Description (continued)****Navigation (continued)**

Using the Jeppesen NavData data and the GPS-supplied present position, the MFD can provide the pilot with the nearest 25 airports or nav aids, depending on pilot selection, within 100 nm. This information is presented on the Nearest page.

More detailed information on a particular airport is also generated from the Jeppesen NavData data and is available for pilot viewing on the Info page.

Flight plan data supplied by the GPS system provide the pilot with a tabular form of the remaining legs in the active GPS flight plan. This information is viewed on the Trip page and includes a CDI for added enroute navigation aiding.

Flight plan data is transmitted to the MFD from an external GPS navigator. Some installations do not support depictions of curved flight paths. In these cases, curved flight path segments will be depicted as straight lines. The GPS navigator and HSI are to be used during approach procedures. Reference the Avidyne FlightMax EX5000 Series Pilot's Guide, p/n 600-00105-000, for more information.

**Datalink**

Datalink information is received by the MFD based upon installation provisions and a subscription service available through Avidyne ([www.myavidyne.com](http://www.myavidyne.com)). Data is presented on the Map, Trip, and Nearest pages. Datalink information is provided for strategic planning purposes only. Data aging and transport considerations make it unsuitable for tactical use. Reference the Avidyne FlightMax EX5000 Series Pilot's Guide, p/n 600-00105-000, for more information.

**Setup**

The various System Setup pages allow the pilot to set user preferences for system operation. In addition to listing the software version identification information and database validity dates, the System Setup page allows access to several pages for preference selection and provides a means to initiate self-tests of the traffic and lightning sensors.

**SECTION 7 - DESCRIPTION AND OPERATION (continued)**

**B. MFD Systems Description (continued)**

**Setup (continued)**

**Airport Settings** page provides selections for displaying airport type, runway surface type and minimum runway lengths on the moving map. **Declutter Settings** page allows the pilot to select settings for defining the base map detail when changing display range. **System Time** page provides an opportunity to select system time zone and Map page menu timeout options. **DataBlock Edit** page allows the pilot to select the data to be displayed in the datablock windows on the Map page. **Datalink Setup** page allows the pilot to select parameters for the datalink system, including update rate and range of weather data request.

**Engine Instruments**

The Engine page provides the pilot with engine parameters depicted on simulated gauges and electrical system parameters located in dedicated regions within the MFD display. An Engine Sensor Unit interfaces with engine-mounted sensors and provides data to the MFD for display.

A leaning function assists the pilot in leaning the engine for best power or best fuel economy. To initiate the leaning function, press the Lean Assist bezel key and proceed to lean the engine fuel mixture. Best economy is achieved when the engine is operating at peak EGT of the leanest cylinder (first cylinder to peak), as recommended by the engine manufacturer. Best power is achieved when the engine is leaned to the first cylinder to reach its EGT peak. When leaning is complete, select Absolute or Normalize to complete the leaning process. A digital readout of EGT change from the peak value is provided for reference. Reference the Avidyne FlightMax EX5000 series Pilot's Guide, p/n 600-00105-000, for more information.

**SECTION 7 - DESCRIPTION AND OPERATION (continued)****C. STANDBY ALTERNATOR System Description**

The B&C Specialty Products Standby Alternator system automatically delivers electrical power to the aircraft electrical power bus in the event of failure of the primary alternator, provided the STBY ALTR switch is in the ON position. Powering the bus allows the pilot flexibility to choose equipment suitable to the current flight conditions. Equipment that would otherwise deplete the battery reserve may be used within the standby alternator's current limit.

The standby alternator controller monitors the aircraft electrical power bus voltage and activates the standby alternator if the bus voltage falls to less than 26.0 volts. As long as the electrical load is maintained below standby alternator capacity, the bus voltage will not fall below 25.0 volts and the battery will remain charged. Certain flight maneuvers such as climbs and lower power settings will result in an engine RPM less than 2500. Flight conditions resulting in less than 2500 engine RPM will reduce the standby alternator system capability and possibly require load shedding to maintain a system voltage above 25 volts. As long as a minimum bus voltage of 25 volts is maintained, battery energy will then be available for gear extension, flap extension and other approach loads.

The standard aircraft amperage indication represents the standby alternator output when the STBY ALTR ON annunciator is lit.

The standby alternator is capable of outputs greater than maximum continuous load for less than 5 minutes without damage. Extended operation over rated load may cause immediate or premature alternator failure and battery depletion.

**THIS PAGE INTENTIONALLY LEFT BLANK**



**PILOT'S OPERATING HANDBOOK  
AND  
FAA APPROVED AIRPLANE FLIGHT MANUAL  
  
SUPPLEMENT NO. 14  
FOR  
GARMIN GNS 430W VHF COMMUNICATION  
TRANSCEIVER/VOR/ILS RECEIVER/GPS RECEIVER**

This supplement must be attached to the Pilot's Operating Handbook and FAA Approved Airplane Flight Manual when the Garmin GNS 430W VHF Communication Transceiver/VOR/ILS Receiver/Global Positioning System is installed per the Equipment List. The information contained herein supplements or supersedes the Pilot's Operating Handbook and FAA Approved Airplane Flight Manual only in those areas listed herein. For limitations, procedures and performance information not contained in this supplement, consult the Pilot's Operating Handbook and FAA Approved Airplane Flight Manual.

FAA APPROVED:

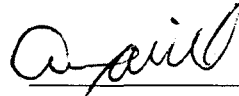

Albert J. Mill  
DOA-510620-CE  
Piper Aircraft, Inc.  
Vero Beach, Florida

DATE OF APPROVAL: May 23, 2008

**SECTION 1 - GENERAL**

The GNS430W System is a fully integrated, panel mounted instrument, which contains a VHF Communications Transceiver, a VOR/ILS receiver, and a WAAS-enabled Global Positioning System (GPS) Navigation computer. The system consists of a GPS antenna, GPS/WAAS receiver, VHF VOR/LOC/GS antenna, VOR/ILS receiver, VHF COMM antenna and a VHF Communications transceiver. The primary function of the VHF Communication portion of the equipment is to facilitate communication with Air Traffic Control. The primary function of the VOR/ILS Receiver portion of the equipment is to receive and demodulate VOR, Localizer, and Glide Slope signals. The primary function of the GPS/WAAS portion of the system is to acquire signals from the GPS system satellites, recover orbital data, make range and Doppler measurements, and process this information in real-time to obtain the user's position, velocity, and time.

Provided the GARMIN GNS 430W's GPS/WAAS receiver is receiving adequate usable signals, it has been demonstrated capable of and has been shown to meet the accuracy specifications for:

- GPS/WAAS TSO-C146a Class 3 Operation: The Garmin GNS430W uses GPS and WAAS (within the coverage of a Space-Based Augmentation System complying with ICAO Annex 10) for enroute, terminal area, non-precision approach operations (including "GPS" and "RNAV" approaches) and approach procedures with vertical guidance (including "LNAV/VNAV" and "LPV").

GPS navigation is accomplished using the WGS-84 (NAD-83) coordinate reference datum. GPS navigation data is based upon use of only the Global Positioning System (GPS) operated by the United States of America.

**SECTION 1 - GENERAL (continued)****Class II Oceanic, Remote, and other operations**

The Garmin 430W has been found to comply with the requirements for GPS primary means of Class II navigation in oceanic and remote airspace when used in conjunction with Garmin Prediction Program part number 006-A0154-03. Oceanic operations are supported when the GNS430W unit annunciates OCN. This provides an alarm limit of four nautical miles and a mask angle of five degrees. The GNS430W unit also has the ability to predict RAIM availability at any waypoint in the database if WAAS corrections are expected to be absent or disabled. This does not constitute an operational approval for Oceanic or Remote area operations. Additional equipment installations or operational approvals may be required.

- Oceanic navigation requires an additional approved long range oceanic and/or remote area navigation system with independent display, sensors, antenna, and power source.
- Redundant VHF Com and VHF Nav systems may be required for other than US 14 CFR Part 91 operations. Check foreign regulation requirements as applicable.
- Operations approval may be granted for the use of the GNS430W unit RAIM prediction function in lieu of the Prediction Program for operators requiring this capability. Refer to your appropriate civil aviation authorities for these authorizations.

**SECTION 2 – LIMITATIONS**

**Pilot's Guide**

The Garmin 400W Series Pilot's Guide, part number and revision listed below (or later revisions), must be immediately available for the flight crew whenever navigation is predicated on the use of the GNS430W unit.

- 400W Series Pilot's Guide & Reference P/N 190-00356-00 Rev. B

This AFM supplement does not grant approval for IFR operations to aircraft limited to VFR operations. Additional aircraft systems may be required for IFR operational approval.

**System Software**

The system must utilize the Main and GPS software versions listed below (or later FAA approved versions for this installation). The software versions are displayed on the self-test page immediately after turn-on, for approximately 5 seconds, or they can be accessed in the AUX pages.

Subsequent software versions may support different functions. Check the 400W Series Pilot's Guide for further information.

<b>Approved Software Versions</b>		
<b>Software Item</b>	<b>Approved Software Version (or later FAA-approved versions)</b>	
	<b>Software Version</b>	<b>As Displayed on Unit</b>
Main Software Version	3.0	3.0
GPS Software Version	3.0	3.0

**Table 1**

**Navigation Data Base**

The GNS430W unit database cards listed in the following table (or later FAA approved versions for this installation) must be installed.

- IFR enroute and terminal navigation is prohibited unless the pilot verifies the currency of the database or verifies each selected waypoint for accuracy by reference to current approved data.

**SECTION 2 - LIMITATIONS (continued)****Navigation Data Base (continued)**

- GPS instrument approaches using the GNS430W are prohibited, unless the GNS430W's approach data is verified by the pilot or crew to be current. Instrument approaches must be accomplished in accordance with an approved instrument approach procedure that is loaded from the GNS430W's database.
- Installations with dual 430W units will only crossfill between those units when they contain the same database cycle. Updating of each database must be accomplished on the ground prior to flight.

**Approved Navigation Database Cards**

<b>Part Number</b>	<b>Description</b>
010-10546-00	Data Card, WAAS, IFR, World Wide
010-10546-01	Data Card, WAAS, IFR, Americas
010-10546-02	Data Card, WAAS, IFR, International

**Table 2**

**SECTION 2 - LIMITATIONS (continued)**

**Terrain Data Base**

The GNS430W supports Terrain and requires a Terrain database card to be installed in order for the feature to operate. The table below lists compatible database cards for the GNS430W. Each of the database cards contains the following data:

- The Terrain Database has an area of coverage from North 75° Latitude to South 60° Latitude in all longitudes.
- The Airport Terrain Database has an area of coverage that includes the United States, Canada, Mexico, Latin America, and South America.
- The Obstacle Database has an area of coverage that includes the United States, and is updated as frequently as every 56 days.

**NOTE**

The area of coverage may be modified as additional terrain data sources become available.

**Approved Terrain Database Cards**

<b>Part Number</b>	<b>Description</b>
010-10201-20	Data Card, TAWS / Terrain, 128MB
010-10201-21	Data Card, TAWS / Terrain, 256MB

**Table 3**

**Navigation**

No navigation is authorized north of 89° (degrees) north latitude or south of 89° (degrees) south latitude.

**SECTION 2 - LIMITATIONS (continued)****Approaches**

- During GPS approaches, the pilot must verify the GNS430W unit is operating in the approach mode. (LNAV, LNAV+V, L/VNAV, or LPV.)
- When conducting approaches referenced to true North, the heading selection on the AUX pages must be adjusted to TRUE.
- Accomplishment of an ILS, LOC, LOC-BC, LDA, SDF, MLS, VOR approach, or any other type of approach not approved for GPS overlay, is not authorized with GPS navigation guidance.
- Use of the GNS430W VOR/LOC/GS receiver to fly approaches not approved for GPS requires VOR/LOC/GS navigation data to be present on the external indicator (i.e. proper CDI source selection).

**Terrain Display**

Terrain refers to the display of terrain information. Pilots are NOT authorized to deviate from their current ATC clearance to comply with terrain/obstacle alerts. Terrain unit alerts are advisory only and are not equivalent to warnings provided by a Terrain Awareness and Warning System (TAWS). Navigation must not be predicated upon the use of the terrain display.

The terrain display is intended to serve as a situational awareness tool only. By itself, it may not provide either the accuracy or the fidelity on which to base decisions and plan maneuvers to avoid terrain or obstacles.

**VNAV**

VNAV information may be utilized for advisory information only. Use of VNAV information for instrument Approach Procedures does not guarantee Step-Down Fix altitude protection, or arrival at minimums in a normal position to land.

**SECTION 3 - EMERGENCY PROCEDURES**

**Emergency Procedures**

No change.

**Abnormal Procedures**

- If the Garmin GNS430W GPS navigation information is not available, or is invalid, utilize other remaining operational navigation equipment installed in the airplane as appropriate. If the 430W loses GPS position and reverts to Dead Reckoning mode (indicated by the annunciation of “DR” in the lower left of the display), the moving map will continue to be displayed. Aircraft position will be based upon the last valid GPS position and estimated by Dead Reckoning methods. Changes in airspeed or winds aloft can affect the estimated position substantially. Dead Reckoning is only available in Enroute mode; Terminal and Approach modes do not support DR.
- If a “Loss of Integrity” (INTEG) message is displayed during:
  - Enroute/Terminal: continue to navigate using GPS equipment and periodically cross-check the GPS guidance to other approved means of navigation.
  - GPS Approach: GPS approaches are not authorized under INTEG - Execute missed approach or revert to alternate navigation.
- During a GPS LPV precision approach or GPS LNAV/VNAV approach, the 430W will downgrade the approach if the Horizontal or Vertical alarm limits are exceeded. This will cause the vertical guidance to flag as unavailable. The procedure may be continued using the LNAV only minimums.
- During any GPS approach in which precision and non-precision alarm limits are exceeded, the 430W will flag the lateral guidance and generate a system message “ABORT APPROACH loss of navigation”. Immediately upon acknowledging the message the unit will revert to Terminal alarm limits. If the position integrity is within these limits, lateral guidance will be restored and the GPS may be used to execute the missed approach, otherwise alternate means of navigation should be utilized.
- In an in-flight emergency, depressing and holding the Comm transfer button for 2 seconds will select the emergency frequency of 121.500 Mhz into the “Active” frequency window.



**SECTION 4 - NORMAL PROCEDURES**

Refer to the 400W Series unit Pilot's Guide defined in Section 2 - Limitations of this supplement for normal operating procedures. This includes all GPS operations, VHF COM and NAV, and Multi-Function Display (optional) information.

Although intuitive and user friendly, the GNS430W requires a reasonable degree of familiarity to prevent operations without becoming too engrossed at the expense of basic instrument flying in IMC and basic see-and-avoid in VMC. Pilot workload will be higher for pilots with limited familiarity in using the unit in an IFR environment. Garmin provides excellent training tools with the Pilot's Guide and PC based simulator. Pilots should take full advantage of these training tools to enhance system familiarization.

**Approaches with Vertical Guidance**

The GNS430W supports three types of GPS approaches with vertical guidance: LPV approaches, LNAV/VNAV (annunciated as L/VNAV) approaches, and LNAV approaches with advisory vertical guidance (annunciated as LNAV+V). For LNAV approaches with advisory vertical guidance, the GNS430W will annunciate LNAV+V indicating vertical guidance is available. LNAV minimums will be controlling in this case.

**NOTE**

If flying an LPV or LNAV/VNAV approach, be prepared to fly the LNAV only approach prior to reaching the final approach fix (FAF). If the GPS integrity is not within vertical approach limits, the system will flag the vertical guidance. This may be annunciated by a downgrade to LNAV message.

For additional information on approaches with vertical guidance, refer to the 400W Series unit Pilot's Guide.

**SECTION 4 - NORMAL PROCEDURES (continued)**

**WFDE Prediction Program**

The Garmin WAAS Fault Detection and Exclusion (WFDE) Prediction Program is required for Remote/Oceanic operations.

The Prediction Program should be used in conjunction with the Garmin 400W/500W Simulator. After entering the intended route of flight in the Simulator flight plan, the pilot selects the FDE Prediction Program under the Options menu of the Simulator program.

For detailed information, refer to the WFDE Prediction Program instructions (190-00643-01). The availability of FDE is only required for Oceanic or Remote operations.

**SECTION 5 - PERFORMANCE**

No change.

**SECTION 6 - WEIGHT AND BALANCE**

No change.

**SECTION 7 - DESCRIPTION AND OPERATION**

See Garmin 400W Series unit Pilot's Guide for a complete description of the GNS430W unit.

**THIS PAGE INTENTIONALLY LEFT BLANK**

**PILOT'S OPERATING HANDBOOK  
AND  
FAA APPROVED AIRPLANE FLIGHT MANUAL**

**SUPPLEMENT NO. 15  
FOR  
BENDIX/KING KR-87 DIGITAL ADF  
WITH KI-227 INDICATOR**

This supplement must be attached to the Pilot's Operating Handbook and FAA Approved Airplane Flight Manual when the Bendix/King KR-87 Digital ADF with the KI-227 Indicator is installed per the Equipment List. The information contained herein supplements or supersedes the Pilot's Operating Handbook and FAA Approved Airplane Flight Manual only in those areas listed herein. For limitations, procedures and performance information not contained in this supplement, consult the Pilot's Operating Handbook and FAA Approved Airplane Flight Manual.

FAA APPROVED:

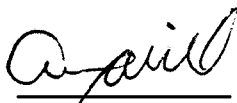

Albert J. Mill  
DOA-510620-CE  
Piper Aircraft, Inc.  
Vero Beach, Florida

DATE OF APPROVAL: October 15, 2008

**SECTION 1 - GENERAL**

The Bendix/King Digital ADF is a panel mounted, digitally tuned, automatic direction finder. It is designed to provide continuous 1 kHz digital tuning in the frequency range of 200 kHz to 1799 kHz and eliminates the need for mechanical band switching. The system is comprised of a receiver, a built-in electronic timer, a bearing indicator and a KA-44B combined loop and sense antenna.

The Bendix/King Digital ADF can be used for position plotting and homing procedures, and for aural reception of amplitude modulated (AM) signals.

The "flip-flop" frequency display allows switching between pre-selected "STANDBY" and "ACTIVE" frequencies by pressing the frequency transfer button. Both preselected frequencies are stored in a non-volatile memory circuit (no battery power required) and displayed in self-dimming gas discharge numerics. The active frequency is continuously displayed in the left window, while the right window will display either the standby frequency or the selected readout from the built-in timer.

The built-in electronic timer has two separate and independent timing functions: (1) An automatic flight timer that starts whenever the unit is turned on. This timer functions up to 59 hours and 59 minutes. (2) An elapsed timer which will count up or down for up to 59 minutes and 59 seconds. When a preset time interval has been programmed and the countdown reaches :00, the display will flash for 15 seconds. Since both the flight timer and elapsed timer operate independently, it is possible to monitor either one without disrupting the other. The pushbutton controls and the bearing indicator are internally lighted.

**SECTION 2 - LIMITATIONS**

No change.

**SECTION 3 - EMERGENCY PROCEDURES**

No change.

**SECTION 4 - NORMAL PROCEDURES****To Operate as an Automatic Direction Finder:**

1. OFF/VOL Control - ON.
2. Frequency Selector Knobs - SELECT desired frequency in the standby frequency display.
3. FRQ Button - PRESS to move the desired frequency from the standby to the active position.
4. ADF SPEAKER/PHONE - Selector Switch (on audio control panel) - SELECT as desired.
5. OFF/VOL Control - SET to desired volume level.
6. ADF Button - SELECT ADF mode and note relative bearing on indicator.

**ADF Test (Pre-flight or In-flight):**

1. ADF Button - SELECT ANT mode and note pointer moves to 90° position.
2. ADF Button - SELECT ADF mode and note the pointer moves without hesitation to the station bearing. Excessive pointer sluggishness, wavering or reversals indicate a signal that is too weak or a system malfunction.

**SECTION 4 - NORMAL PROCEDURES (continued)**

**NOTE**

The Standby Frequency which is in memory while Flight Time or Elapsed Time modes are being displayed may be called back by pressing the FRQ button, then transferred to active use by pressing the FRQ button again.

**To Operate Elapsed Time Timer-Count Down Mode:**

1. OFF/VOL Control - ON.
2. FLT/ELT Mode Button - PRESS (once or twice) until ET is annunciated.
3. SET/RST Button - PRESS until the ET annunciation begins to flash.
4. FREQUENCY SELECTOR KNOBS - SET desired time in the elapsed time display. The small knob is pulled out to tune the 1's. The small knob is pushed in to tune the 10's. The outer knob tunes minutes up to 59 minutes.

**NOTE**

Selector knobs remain in the time set mode for 15 seconds after the last entry or until the SET/RST, FLT/ET, or FRQ button is pressed.

5. SET/RST Button - PRESS to start countdown. When the timer reaches 0, it will start to count up as display flashes for 15 seconds.

**NOTE**

While FLT or ET are displayed, the active frequency on the left side of the window may be changed, by using the frequency selector knobs, without any effect on the stored standby frequency or the other modes.



**SECTION 4 - NORMAL PROCEDURES (continued)****ADF Operation NOTES:***Erroneous ADF Bearing Due to Radio Frequency Phenomena:*

In the U.S., the FCC, which assigns AM radio frequencies, occasionally will assign the same frequency to more than one station in an area. Certain conditions, such as Night Effect, may cause signals from such stations to overlap. This should be taken into consideration when using AM broadcast station for navigation.

Sunspots and atmospheric phenomena may occasionally distort reception so that signals from two stations on the same frequency will overlap. For this reason, it is always wise to make positive identification of the station being tuned, by switching the function selector to ANT and listening for station call letters.

*Electrical Storms:*

In the vicinity of electrical storms, an ADF indicator pointer tends to swing from the station tuned toward the center of the storm.

*Night Effect:*

This is a disturbance particularly strong just after sunset and just after dawn. An ADF indicator pointer may swing erratically at these times. If possible, tune to the most powerful station at the lowest frequency. If this is not possible, take the average of pointer oscillations to determine relative station bearing.

*Mountain Effect:*

Radio waves reflecting from the surface of mountains may cause the pointer to fluctuate or show an erroneous bearing. This should be taken into account when taking bearings over mountainous terrain.

*Coastal Refraction:*

Radio waves may be refracted when passing from land to sea or when moving parallel to the coastline. This also should be taken into account.

**SECTION 5 - PERFORMANCE**

No change.

**SECTION 6 - WEIGHT AND BALANCE**

Factory installed optional equipment is included in the licensed weight and balance data in Section 6 of the Pilot's Operating Handbook and Airplane Flight Manual.

## SECTION 7 - DESCRIPTION AND OPERATION

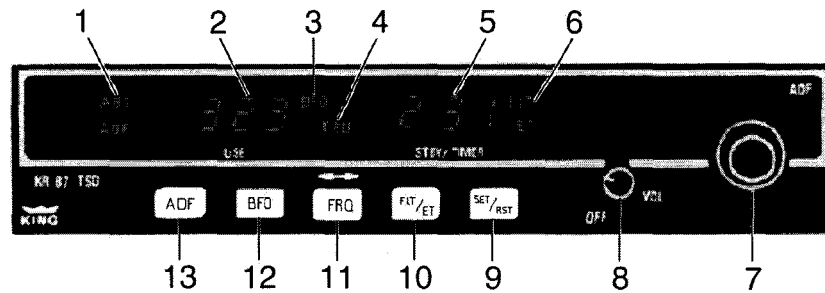

KR-87 Digital ADF

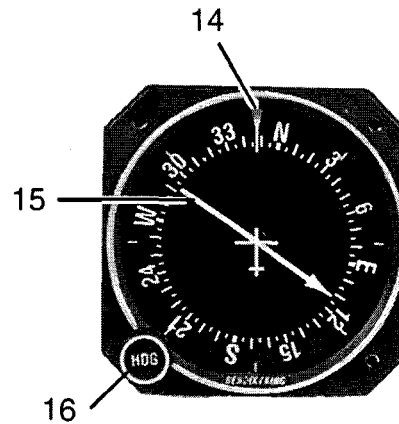

KI-227 Indicator

King Digital ADF Operating Controls and Indicators  
Figure 1

**SECTION 7 - DESCRIPTION AND OPERATION (continued)**

**Legend - Figure 1**

1. Mode Annunciation - Antenna (ANT) is selected by the "out" position of the ADF button. This mode improves the aural reception and is usually used for station identification. The bearing pointer is deactivated and will park in the 90° relative position. Automatic Direction Finder (ADF) mode is selected by the depressed position of the ADF button. This mode activates the bearing pointer. The bearing pointer will point in the direction of the station relative to the aircraft heading.
2. Active Frequency Display - The frequency to which the ADF is tuned is displayed here. The active ADF frequency can be changed directly when either of the timer functions are selected.
3. Beat Frequency Oscillator (BFO) - The BFO mode, activated and annunciated when the "BFO" button is depressed, permits the carrier wave and associated morse code identifier broadcast on the carrier wave to be heard.

**NOTE**

CW signals (Morse Code) are unmodulated and no audio will be heard without use of BFO. This type of signal is not used in the United States air navigation. It is used in some foreign countries and marine beacons.

4. Standby Frequency Annunciation (FRQ) - When FRQ is displayed, the STANDBY frequency is displayed in the right hand display. The STANDBY frequency is selected using the frequency select knobs. The selected STANDBY frequency is put into the ACTIVE frequency window by pressing the frequency transfer button.
5. Standby Frequency Display - Either the standby frequency, the flight timer, or the elapsed time is displayed in this position. The flight timer and elapsed timer are displayed replacing the standby frequency which goes into "blind" memory to be called back at any time by depressing the FRQ button. Flight time or elapsed time are displayed and annunciated alternatively by depressing the FLT/ET button.

**SECTION 7 - DESCRIPTION AND OPERATION (continued)****Legend - Figure 1 (continued)**

6. Timer Mode Annunciation - Either the elapsed time (ET) or flight time (FLT) mode is annunciated here.
7. Frequency Selector Knobs - Selects the standby frequency when FRO is displayed and directly selects the active frequency whenever either of the timer functions is selected. The frequency selector knobs may be rotated either clockwise or counterclockwise. The small knob is pulled out to tune the 1's. The small knob is pushed in to tune the 10's. The outer knob tunes the 100's with rollover into the 1000's. These knobs are also used to set the desired time when the elapsed timer is used in the countdown mode.
8. Off/Volume Control (OFF/VOL) - Controls primary power and audio output level. Clockwise rotation from OFF position applies primary power to receiver; further clockwise rotation increases audio level. Audio muting causes the audio output to be muted unless the receiver is locked on a valid station.
9. Set/Reset Button (SET/RST) - The set/reset button, when pressed, resets the elapsed timer whether it is being displayed or not.
10. Flight Time/Elapsed Time Mode Selector Button (FLT/ET) - The Flight Timer/Elapsed Time mode selector button, when pressed, alternatively selects either Flight Timer mode or Elapsed Timer mode.
11. Frequency Transfer Button (FRQ) - The FRQ transfer button, when pressed, exchanges the active and standby frequencies. The new frequency becomes active and the former active frequency goes into standby.
12. BFO Button - The BFO button selects the BFO mode when in the depressed position (see Note under item 3).
13. ADF Button - The ADF button selects either the ANT mode or the ADF mode. The ANT mode is selected with the ADF button in the out position. The ADF mode is selected with the ADF button in the depressed position.
14. Index (Rotatable Card) - Indicates relative, magnetic, or true heading of aircraft, as selected by the HDG control.

**SECTION 7 - DESCRIPTION AND OPERATION (continued)**

**Legend - Figure 1 (continued)**

15. Pointer - Indicates station bearing in degrees of azimuth, relative to the nose of the aircraft. When heading control is adjusted, indicates relative, magnetic, or true bearing of radio signal.
16. Heading Card Control (HDG) - Rotates card to set in relative, magnetic, or true bearing information.

**PILOT'S OPERATING HANDBOOK  
AND  
FAA APPROVED AIRPLANE FLIGHT MANUAL  
  
SUPPLEMENT NO. 16  
FOR  
BENDIX/KING KN-63 DME**

This supplement must be attached to the Pilot's Operating Handbook and FAA Approved Airplane Flight Manual when the Bendix/King KN-63 DME is installed per the Equipment List. The information contained herein supplements or supersedes the Pilot's Operating Handbook and FAA Approved Airplane Flight Manual only in those areas listed herein. For limitations, procedures and performance information not contained in this supplement, consult the Pilot's Operating Handbook and FAA Approved Airplane Flight Manual.

FAA APPROVED:



Albert J. Mill  
DOA-510620-CE  
Piper Aircraft, Inc.  
Vero Beach, Florida

DATE OF APPROVAL: October 15, 2008

**SECTION 1 - GENERAL**

The Bendix/King KN-63 DME supplies continuous slant range distance information from a fixed ground station to an aircraft in flight.

The equipment consists of a KDI-572 Panel Display which contains all the operating controls and displays, and a remotely mounted KN-63 Receiver-Transmitter. The KDI-572 Panel Display digitally displays distances in nautical miles, ground speed in knots, and time to station in minutes. All displays are in self-dimming gas discharge numerics.

**SECTION 2 - LIMITATIONS**

No change.

**SECTION 3 - EMERGENCY PROCEDURES**

No change.

**SECTION 4 - NORMAL PROCEDURES**

**DME Operation**

1. DME Mode Selector Switch - SET to N1 or N2.
2. NAV 1 and NAV 2 VHF Navigation Receivers - ON; SET FREQUENCY selector switches to VOR/DME station frequencies, as required.

**NOTE**

When the VOR frequency is selected, the appropriate DME frequency is automatically channeled.

3. DME SPEAKER/PHONE selector buttons (on audio control panel) - SET to desired mode.

**SECTION 5 - PERFORMANCE**

No change.

**SECTION 6 - WEIGHT AND BALANCE**

Factory installed optional equipment is included in the licensed weight and balance data in Section 6 of the Pilot's Operating Handbook and Airplane Flight Manual.



## SECTION 7 - DESCRIPTION AND OPERATION

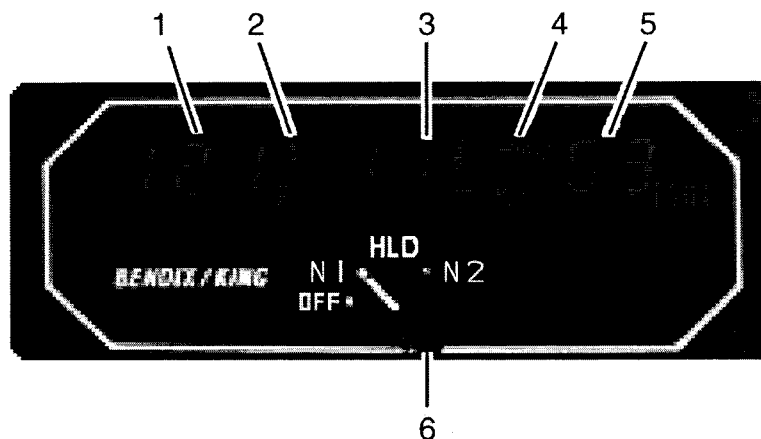

Bendix/King KN-63 DME

Figure 1

## Legend - Figure 1

1. DISTANCE DISPLAY (NM) - DME distance to VORTAC/WAYPOINT displayed in .1 nautical mile increments up to 99.9 NM, then in increments of one nautical mile to 389 NM.
2. DME MODE ANNUNCIATOR - Displays the DME operating mode; NAV 1 (1); NAV 2 (2); NAV 1 HOLD (H1); NAV 2 HOLD (H2); of the mode selector switch (6).
3. GROUND SPEED DISPLAY (KT) - Displays ground speed in knots to or from VORTAC/WAYPOINT up to 999 knots (aircraft must be flying directly to or from the VORTAC/WAYPOINT for true ground speed indication).
4. RNAV ANNUNCIATOR (RNV) - Indicates RNV when displayed data is in relation to the RNAV waypoint. If the wrong DME mode is selected during RNAV operation, the RNAV annunciator will flash.
5. TIME-TO-STATION DISPLAY (MIN) - Displays time-to-station (VORTAC/WAYPOINT) in minutes up to 99 minutes (aircraft must be flying directly to or from the Vortac/Waypoint for true time-to-station indication).

**SECTION 7 - DESCRIPTION AND OPERATION (continued)**

**Legend - Figure 1 (continued)**

6. DME MODE SELECTOR SWITCH (OFF, N1, HLD, N2) - Applies power to the DME and selects DME operating mode as follows:

OFF: Turns DME power off.

NAV 1

(N1): Selects DME operation with No. 1 VHF navigation set; enables channel selection by NAV 1 frequency selector controls.

HOLD

(HLD): Selects DME memory circuit; DME remains channeled to station to which it was last channeled when HOLD was selected and will continue to display information relative to this channel. Allows both the NAV 1 and NAV 2 navigation receivers to be set to new operational frequencies without affecting the previously selected DME operation.

**NOTE**

In the HOLD mode there is no annunciation of the VOR/DME station frequency. However, an annunciator labeled "H1" or "H2" illuminates on the DME display to flag the pilot that the DME is in the HOLD mode.

NAV 2

(N2): Selects DME operation with No. 2 VHF navigation set; enables channel selection by NAV 2 frequency selector switches. Brightness of the labels for this switch is controlled by the RADIO light dimming rheostat.

# AVIONIK STRAUBING

## ENGINEERING DEPARTMENT

---

DOA Center	<u>Avionik Straubing GmbH</u>	Installation Center	_____
DOA #	<u>EASA 21J.046</u>	Repair Station #	_____
Address	<u>Flugplatz Wallmühle</u>	Address	_____
	<u>D-94348 Atting</u>		_____
	<u>Germany</u>		_____

---

Artex ME406 ELT

## Operating Manual

Installation of Artex ME406

in accordance with

Avionik Straubing Engineering Order ASR2006-059-00

and

Description, Operation, Installation and Maintenance Manual

for the ME406 ELT P/N: 570-1600 Rev. -

AIRCRAFT MAKE: **Piper**

AIRCRAFT MODEL: **PA-28RT-201**

AIRCRAFT SERIAL NO.:

Avionik Straubing GmbH

EASA.21J.046



Gunter Hemmel

Leiter Musterprüfleitstelle

Revision Number	Revision Date	Description
A	28.09.06	Initial Release

**TABLE OF CONTENTS**

SECTION	PAGE
I <b>General</b> .....	3
II <b>Limitations</b> .....	3
III <b>Emergency Procedures</b> .....	3
IV <b>Normal Procedures</b> .....	3
V <b>Performance</b> .....	4
VI <b>Weight and Balance</b> .....	4
VII <b>Airplane &amp; System Description</b> .....	4

## SECTION I - GENERAL

The Artex ME406 ELT is an ELT (Emergency Locator Transmitter) which provides the following functions:

- a. 406MHZ (COSPAS-SARSAT frequency) for precise ping pointing and identification of the aircraft in distress.
- b. 121,5 and 406 MHz used for homing in the final stages of the rescue operations.
- c. It is certified as an Automatic Fixed (AF) ELT and only works with a two frequency outside antenna.

## SECTION II - LIMITATIONS

No limitations

## SECTION III - EMERGENCY PROCEDURES

In the event of a crash, the ME406 activates automatically, and transmits the standard swept tone on 121.5 MHz lasting until battery power is gone. This 121.5 MHz signal is mainly used to pinpoint the beacon during search and rescue operations.

In addition, for the first 24 hours of operation, a 406 MHz signal is transmitting at 50 second intervals. This transmission lasts 440 ms and contains identification data programmed into the beacon and is received by Cospas-Sarsat satellites. The transmitted data is referenced in a database (maintained by the national authority responsible for ELT registration) and used to identify the beacon and owner.

## SECTION IV - NORMAL PROCEDURES

### Operation:

In the event of a crash, the ME406 activates automatically, and transmits the standard swept tone on 121.5 MHz lasting until battery power is gone. This 121.5 MHz signal is mainly used to pinpoint the beacon during search and rescue operations.

**NOTE:** In October 2000 the International Cospas-Sarsat Program, announced at its 25<sup>th</sup> Council Session held in London, UK that it plans to terminate satellite processing of distress signals from 121.5 and 243 MHz emergency beacons on February 1, 2009.

In addition, for the first 24 hours of operation, a 406 MHz signal is transmitting at 50 second intervals. This transmission lasts 440 ms and contains identification data programmed into the beacon and is received by Cospas-Sarsat satellites. The transmitted data is referenced in a database (maintained by the national authority responsible for ELT registration) and used to identify the beacon and owner.

### Switch Operation:

In a crash, an acceleration activated crash sensor (G-switch) turns the ELT 'on' automatically when the ELT experiences a change in velocity (or deceleration) of 4.5 fps  $\pm$ 0.5 fps. Activation is also accomplished by means of the cockpit mounted remote switch or the panel (local) switch on the ELT. To deactivate the ELT set either switch to the 'ON' position, then back to 'ARM'.

The ELT does not have an 'OFF' position. Instead, a jumper between two pins on the front D-sub connector must be in place for the G-switch to activate the unit. The jumper is installed on the mating half of the connector so that when the connector is installed, the beacon is armed. This allows the beacon to be handled or shipped without 'nuisance' activation (front connector removed).

**NOTE:** The ELT can still be manually activated using the local switch on the front of the ELT. Care should be taken when transporting or shipping the ELT not to move the switch or allow packing material to become lodged such as to toggle the switch.

**Self Test mode:**

Upon turn-off, the ELT automatically enters a self-test mode that transmits a 406 MHz test coded pulse that monitors certain system functions before returning to the 'ARM'ed mode. The 406 MHz test pulse is ignored by any satellite that receives the signal, but the ELT uses this output to check output power and correct frequency. If the ELT is left activated for approximately 50 seconds or greater, a distress signal is generated that is accepted by one or more SAR satellites. Therefore, when the self-test mode is required, the ELT must be activated, then, returned to 'ARM' within about 45 seconds otherwise a "live" distress message will be transmitted.

**NOTE:** All activations of the ELT should be kept to a minimum. Local or national regulations may limit testing of the ELT or special requirements or conditions to perform testing. For the "self test", Artex recommends that the ELT be "ON" for no more than 5 seconds during the first 5 minutes after the hour.

In addition to output power of the 121.5/406 MHz signals and 406 MHz frequency, other parameters of the ELT are checked and a set of error codes generated if a problem is found. The error codes are displayed by a series of pulses of the ELT LED, remote LED and alert buzzer. See "Installed Transmitter Test" section on page 37 for more details and a description of the error codes.

**NOTE:** All testing of the ELT referenced in this section may be performed by limiting the transmission of the ELT to 3 sweeps of the 121.5 MHz audio tone. Only transmit within the first 5 minutes after the hour or as specified by local or national regulations.

## SECTION V - PERFORMANCE

No change.

## SECTION VI - WEIGHT AND BALANCE

See current weight and balance date.

## SECTION VII - AIRPLANE & SYSTEM DESCRIPTION

### Periodicity Checks

The periodicity of operation checks is as at the operator's description, however, a monthly test recommended.

The check shall only be conducted during the first five minutes of any UTC hour, and restricting in duration to not more than five seconds.

The complete description see in **DESCRIPTION, OPERATION, INSTALLATION AND MAINTENACE MANUAL** from the ARTEX ME406 ELT with Document Number: 570-1600 Rev. - or later.

The Artex ME406 ELT transmitter battery expiry date is fixed at 5 years after manufacturing. If no activation of the ELT occurs during the battery lifetime, it shall be replaced every 5 years. Is the battery lifetime shorter than 5 years, replace the battery at this time.

Replace the battery also:

- after use in an emergency
- after an inadvertent activation of unknown duration
- when the total of all known transmission exceeds one hour

**TABLE OF CONTENTS**

**SECTION 10**

**OPERATING TIPS**

<b>Paragraph No.</b>		<b>Page No.</b>
10.1	General .....	10-1
10.3	Operating Tips .....	10-1

1967-1968

1969

1970-1971

1972-1973

1974-1975

1976-1977

**THIS PAGE INTENTIONALLY LEFT BLANK**

**REPORT: VB-1610**  
10-6



**SECTION 10  
OPERATING TIPS**

**10.1 GENERAL**

This section provides operating tips of particular value in the operation of the WARRIOR III.

**10.3 OPERATING TIPS**

- (a) Learn to trim for takeoff so that only a very light back pressure on the control wheel is required to lift the airplane off the ground.
- (b) The best speed for takeoff is about 55 KIAS under normal conditions. Trying to pull the airplane off the ground at too low an airspeed decreases the controllability of the airplane in the event of engine failure.
- (c) Flaps may be lowered at airspeeds up to 103 KIAS. To reduce flap operating loads, it is desirable to have the airplane at a slower speed before extending the flaps. The flap step will not support weight if the flaps are in any extended position. The flaps must be placed in the "UP" position before they will lock and support weight on the step.
- (d) Before attempting to reset any circuit breaker, allow a two to five minute cooling off period.
- (e) Before starting the engine, check that all radio switches, light switches and the pitot heat switch are in the off position so as not to create an overloaded condition when the starter is engaged.
- (f) Anti-collision lights should not be operating when flying through cloud, fog or haze, since the reflected light can produce spatial disorientation. Strobe lights should not be used in close proximity to the ground such as during taxiing, takeoff or landing.

- (g) The rudder pedals are suspended from a torque tube which extends across the fuselage. The pilot should become familiar with the proper positioning of his feet on the rudder pedals so as to avoid interference with the torque tube when moving the rudder pedals or operating the toe brakes.
- (h) In an effort to avoid accidents, pilots should obtain and study the safety related information made available in FAA publications such as regulations, advisory circulars, Aviation News, AIM and safety aids.
- (i) Prolonged slips and skids which result in excess of 2000 ft. of altitude loss, or other radical or extreme maneuvers which could cause uncovering of the fuel outlet must be avoided as fuel flow interruption may occur when the tank being used is not full.
- (j) Hand starting of the engine is not recommended, however, should hand starting of the engine be required, only experienced personnel should attempt this procedure. The magneto selector should be placed to LEFT during the starting procedures to reduce the probability of "kick back." Place the ignition switch to BOTH position after the engine has started.